

THE COLLECTION 2026

blomus

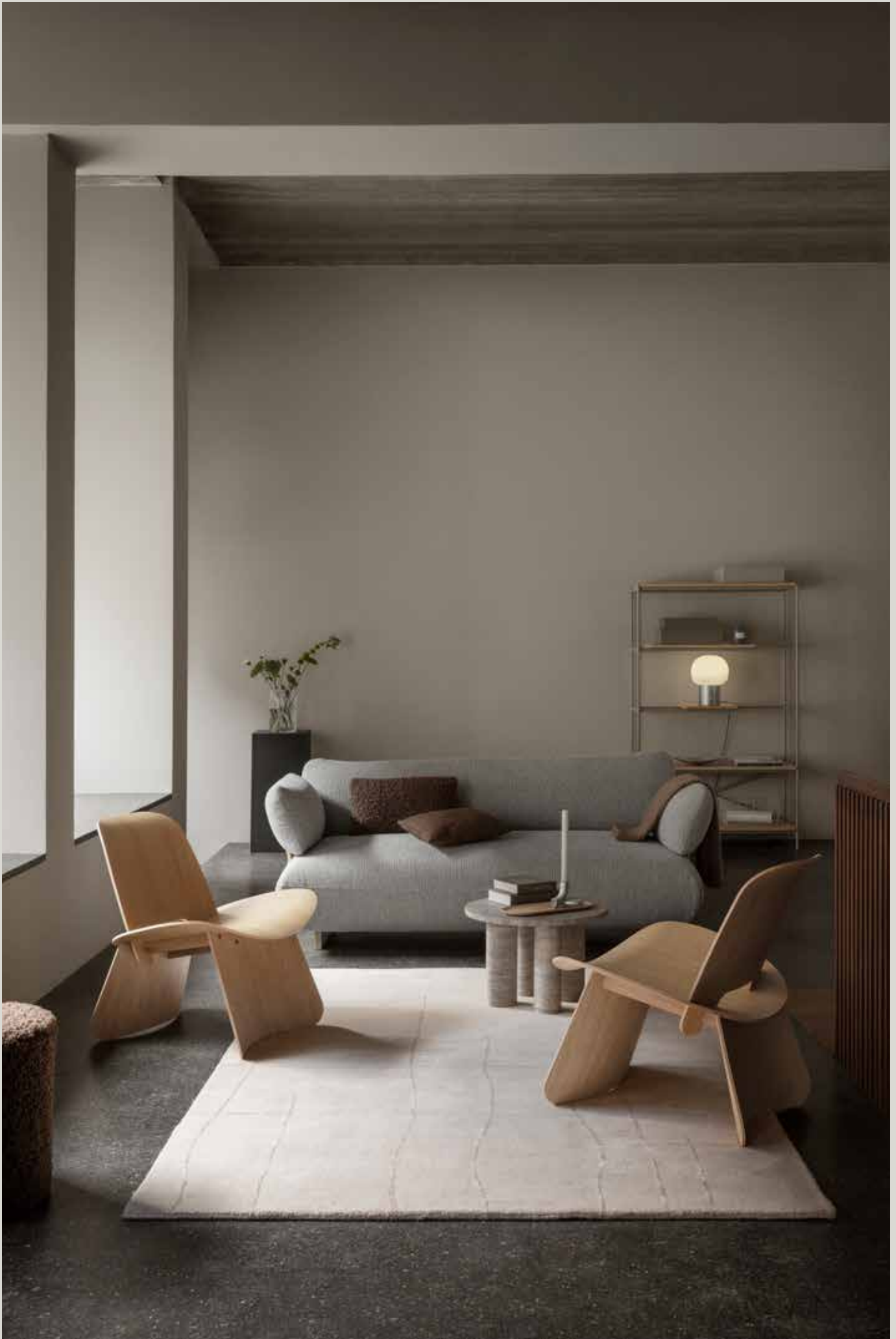



## INTRODUCING BLOMUS

blomus is synonymous with intelligent, minimalist, and functional design for the contemporary home. Founded in 1961 and rooted in the German tradition of exceptional quality and highly skilled craftsmanship, the family-owned brand has built its success on the firm belief in honesty of materials, purity of shape and a passionate approach.

This has made blomus a leading provider of interior design and accessories made to last and be loved for generations to come.

## EINFÜHRUNG BLOMUS

blomus steht für durchdachtes, minimalistisches und funktionales Design für modernes Wohnen. Gegründet im Jahr 1961 und ganz der deutschen Tradition höchster Qualitäts- und Fertigungskompetenz verbunden, begründet sich der Erfolg der Marke des Familienunternehmens auf den Prinzipien des authentischen Materialeinsatzes, der puristischen Formensprache und der Überzeugung, alle Prozesse mit Leidenschaft anzugehen.

Dies macht blomus über Generationen hinweg zu einer der begehrtesten Marken des Interior Design.

## TABLE OF CONTENT

ABOUT BLOMUS		SUBJECT		PRODUCTS	
INTRODUCTION	P. 4	DINING	P. 8	CAPSULE	P. 25
DESIGNERS	P. 352	LIVING	P. 10	DINING	P. 53
CSR	P. 356	BATH	P. 18	LIVING	P. 121
CONTACT	P. 359	OUTDOOR	P. 20	CHRISTMAS	P. 205
				BATH	P. 223
				SCENT	P. 271
				OUTDOOR	P. 291
				PROMOTION	P. 339
				POS	P. 358

## COMING HOME

Most people know that feeling of longing for familiar surroundings – a place where you allow your soul to settle in a room; the soothing feeling of being greeted by a familiar scent as soon as you open the door or the expectation of your soft and welcoming sofa. Homes are filled with habits and routines, life stories and identity: the very place we call home can often feel like the most important anchor in life. These are all good reasons to ask yourself what really makes you feel most at home.

This season, we celebrate belonging and our connection to the places we call home as we are presenting a collection that adds beautiful, functional, and innovative design to every room. Among the highlights is a practical series of storage boxes and baskets for our existing shelving system, helping you effectively organize everything that matters in everyday life. For your bathroom, we are introducing a new series of well-designed accessories that will transform the room into a special haven for the body to find peace and rest. Your kitchen and dining room will be in focus with our new, Japanese-inspired tableware series for your daily meals.

Finally, we look forward to sharing with you that special – yet intangible – feeling of home through our brand-new home fragrance series that will allow you to pick your favourite scent to evoke that special feeling of belonging. No matter the room, we have you covered with a design that will make you feel at home.

Welcome to a new season.

## ZUHAUSE ANKOMMEN

Die meisten Menschen kennen das Gefühl der Sehnsucht nach einer vertrauten Umgebung – einem Ort, an dem man sich wohlfühlt, an dem man sich entspannen kann, an dem man beim Öffnen der Tür von einem vertrauten Duft empfangen wird und an dem man sich auf ein weiches, einladendes Sofa freuen kann. Unser Zuhause ist geprägt von Gewohnheiten und Routinen, Lebensgeschichten und Identität: Der Ort, den wir unser Zuhause nennen, kann oft wie der wichtigste Anker im Leben erscheinen. All dies sind gute Gründe, sich zu fragen, was einem wirklich das Gefühl gibt, zu Hause zu sein.

In dieser Saison feiern wir das Zugehörigkeitsgefühl und unsere Verbundenheit zu den Orten, die wir unser Zuhause nennen, und präsentieren eine Kollektion, die jeden Raum mit schönem, funktionalem und innovativem Design bereichert. Zu den Highlights gehört eine praktische Serie von Aufbewahrungsboxen und Körben für unser bestehendes Regalsystem, mit denen Sie alles, was Ihnen im Alltag wichtig ist, effektiv organisieren können. Für Ihr Badezimmer stellen wir eine neue Serie von gut gestalteten Accessoires vor, die den Raum in eine besondere Oase verwandeln, in der der Körper Ruhe und Erholung findet. Ihre Küche und Ihr Esszimmer stehen mit unserer neuen, japanisch inspirierten Geschirrschere für Ihre täglichen Mahlzeiten im Mittelpunkt.

Schließlich freuen wir uns darauf, mit Ihnen dieses besondere – und doch immaterielle – Gefühl von Zuhause zu teilen, und zwar durch unsere brandneue Raumduftserie, aus der Sie Ihren Lieblingsduft auswählen können, um dieses besondere Gefühl der Zugehörigkeit zu wecken. Ganz gleich, um welchen Raum es sich handelt, wir haben das passende Design für Sie, mit dem Sie sich zu Hause fühlen werden.

Willkommen in einer neuen Saison.



Kasane



---

ESSENTIALS



## WHEN SIMPLICITY BECOMES POETRY

The Makoto collection embodies the Japanese spirit of sincerity. Powerful, geometric shapes meet soft, nature-inspired surfaces to create a tableware collection that radiates calm and clarity.

Made from stoneware in Portugal, the pieces feature matte glazes in warm Nordic tones. Each variation makes them unique, subtly showcasing food and floral arrangements.

## WENN SCHLICHTHEIT ZUR POESIE WIRD

Die Kollektion Makoto verkörpert den japanischen Geist der Aufrichtigkeit. Kraftvolle Geometrien treffen auf sanfte, naturinspirierte Oberflächen – eine Tischkultur, die Ruhe und Klarheit ausstrahlt.

Gefertigt aus Steingut in Portugal, tragen matte Glasuren in nordischen Farbtönen zur Reduktion bei und machen jedes Stück zu einem Unikat. So werden Speisen und Blumenarrangements dezent und doch wirkungsvoll in Szene gesetzt.

DESIGNER

## CARSTEN GOLLNICK

German designer Carsten Gollnick (born 1966) founded his own studio in 1997 and has since developed a clear design language that combines aesthetics and function with the rituals of everyday life. Japanese design tradition in particular influences his thinking – every object, whether large or small, has meaning and value. He has created a diverse body of work, including furniture, lighting and porcelain for international brands, as well as individual projects in close collaboration with craftsmen. Over 100 products bear his signature and have won awards such as the iF Design Award, the German Design Award and the Red Dot.

Der deutsche Designer Carsten Gollnick (geb. 1966) gründete 1997 sein eigenes Studio und entwickelte seither eine klare Formensprache, die Ästhetik und Funktion mit den Ritualen des Alltags verbindet. Besonders die japanische Designtradition prägt sein Denken – jedes Objekt, ob groß oder klein, hat Bedeutung und Wert. Mit Möbeln, Leuchten und Porzellan für internationale Marken sowie individuellen Projekten in enger Zusammenarbeit mit Handwerkern hat er ein vielseitiges Werk geschaffen. Über 100 Produkte tragen seine Handschrift und wurden mit Auszeichnungen wie dem iF Design Award, dem German Design Award und dem Red Dot prämiert.



DESIGNER

## ANTON BJÖRSING

Swedish designer Anton Björsing (born 1983) is a trained carpenter and studied furniture and interior design in Stockholm and London. His designs are deeply rooted in Scandinavian tradition, yet open to new materials and experimentation. With a keen sense for wood and other materials, he creates products that appeal to people and naturally combine form and function. In collaboration with leading Swedish brands, he has established himself as a voice of contemporary Nordic design.

Der schwedische Designer Anton Björsing (geb. 1983) ist ausgebildeter Tischler und studierte Möbel- und Raumgestaltung in Stockholm und London. Seine Entwürfe sind tief in der skandinavischen Tradition verwurzelt und zugleich offen für neue Materialien und Experimente. Mit feinem Gespür für Holz und andere Werkstoffe schafft er Produkte, die Menschen ansprechen und Form und Funktion selbstverständlich vereinen. In Zusammenarbeit mit führenden schwedischen Marken hat er sich als Stimme des zeitgenössischen nordischen Designs etabliert.







## THE PERFECT COMPANION

Some pieces of furniture accompany us flexibly through everyday life – the Eta side table is one of them. Two generous storage surfaces and a practical carrying handle make it a mobile companion that can be used anywhere. Made of solid oak, Eta combines stability with a light, almost floating appearance. The clean lines of the 'A-frame' and the gently rounded details give it a timeless design that is both functional and elegant.

## DER PERFEKTE BEGLEITER

Manche Möbelstücke begleiten uns flexibel durch den Alltag – der Eta Beistelltisch gehört dazu. Zwei großzügige Ablageflächen und ein praktischer Tragegriff machen ihn zu einem mobilen Begleiter, der sich überall einsetzen lässt. Gefertigt aus massivem Eichenholz, verbindet Eta Stabilität mit einer leichten, fast schwebenden Anmutung. Klare Linien im A-Rahmen und sanft abgerundete Details verleihen ihm ein zeitloses Design – funktional und zugleich elegant.



#### ENCHANTING SHAPES AND COLOURS

A stool that brings together a minimalist form with the refined texture unique to ceramic. Its simple shape – resembling a rectangular column with a flat top – functions not only as a stool but also as a side table, adapting flexibly to various scenes in everyday life. The ceramic stool adds a pleasant accent to any space with both its distinctive surface texture and original choice of colors.

#### FORMEN UND FARBEN ZUM VERZAUBERN

Ein Hocker, der eine minimalistische Form mit der raffinierten, für Keramik typischen Textur vereint. Seine schlichte Form – einer rechteckigen Säule mit flacher Oberseite ähnlich – dient nicht nur als Hocker, sondern auch als Beistelltisch und passt sich flexibel unterschiedlichen Alltagssituationen an. Der Keramikhocker setzt sowohl durch seine markante Oberflächenstruktur als auch die originelle Farbauswahl in jedem Raum einen angenehmen Akzent.

DESIGNER

## KAZUSHIGE MIYAKE

Japanese designer Kazushige Miyake (born 1973) studied at Tama Art University in Tokyo and founded his own studio in 2005. His works are characterised by clear, functional design – from armchairs to everyday objects – always reduced to the essentials. In each design, Miyake seeks to find the unique form of an object, encompassing not only its shape but also its atmosphere and effect. He has received numerous international awards for his work and is now himself a member of the juries for the iF Design Award and the Good Design Award.

Der japanische Designer Kazushige Miyake (geb. 1973) studierte an der Tama Art University in Tokio und gründete 2005 sein eigenes Studio. Seine Arbeiten stehen für klares, funktionales Design – von Sesseln bis hin zu Alltagsobjekten – immer reduziert auf das Wesentliche. Miyake sucht in jedem Entwurf nach der eigenen Form eines Objekts, die nicht nur seine Gestalt, sondern auch die Atmosphäre und Wirkung umfasst. Für seine Arbeiten erhielt er zahlreiche internationale Auszeichnungen und ist heute selbst Mitglied in den Jurys des iF Design Award und des Good Design Award.





DESIGNER

## DANIEL LAVONIUS JAREFELDT

Stockholm-based designer Daniel Lavonius Jarefeldt (born 1983) studied in Lund and Sydney and has been working as a product designer and interior designer since 2010. After helping to establish one of Sweden's largest design studios, he founded his own studio in 2020, focusing on furniture and product design. His designs are the result of a clearly structured process and follow a human-centred approach.

Der in Stockholm lebende Designer Daniel Lavonius Jarefeldt (geb. 1983) studierte in Lund und Sydney und arbeitet seit 2010 als Produktdesigner und Innenarchitekt. Nach seiner Mitwirkung am Aufbau eines der größten schwedischen Designstudios gründete er 2020 sein eigenes Atelier mit Fokus auf Möbel- und Produktdesign. Seine Entwürfe entstehen aus einem klar strukturierten Prozess und folgen einem menschenzentrierten Ansatz. So entstehen Produkte mit eindeutiger Funktion und eigener Identität – ehrlich in Material und Konstruktion, selbstverständlich im Raum.

THE ART OF LIGHTNESS

The modular Doodle candle holder combines functionality with playful lightness and sculptural expression. Two intersecting arches form both the holder and the support – minimalist in design, yet full of character. Whether used individually or combined to form larger candlesticks, the result is a clear, graphic design language that is extremely versatile. Available in coloured versions or made of metal, Doodle is a modern object with emotional appeal.

DIE KUNST DER LEICHTIGKEIT

Der modulare Kerzenhalter Doodle verbindet Funktion mit spielerischer Leichtigkeit und skulpturalem Ausdruck. Zwei sich kreuzende Bögen formen zugleich Halter und Stütze – minimalistisch im Entwurf, doch voller Charakter. Ob einzeln genutzt oder zu größeren Leuchtern kombiniert, entsteht eine klare, grafische Formensprache, die vielseitig einsetzbar ist. In farbigen Varianten oder aus Metall gefertigt, wird Doodle zu einem modernen Objekt mit emotionaler Ausstrahlung.



Doodle



## OPPOSITES IN HARMONY

The vase was created from the idea of combining two contradictory shapes. From one angle, the vase appears straight and angular, but when viewed from the side, a second, more organic form with a gentle curve becomes apparent. This appearance is achieved through inverted reflections of the side elements as well as the opening in relation to the base. The vase therefore consists of twisted, mirrored sides.

## GEGENSÄTZE IN HARMONIE

Die Vase entstand aus der Idee, zwei gegensätzliche Formen zu kombinieren. Aus einem Blickwinkel erscheint die Vase gerade und eckig, aber von der Seite betrachtet wird eine zweite, organischere Form mit einer sanften Kurve sichtbar. Dieser Effekt wird durch die umgekehrten Reflexionen der Seitenelemente sowie durch die Öffnung im Verhältnis zum Sockel erzielt. Die Vase besteht somit aus verdrehten, gespiegelten Seiten.

DESIGNER

## ILJA HUBER

Ilja Huber (born 1983) is a Berlin-based product designer whose work focuses on furniture, lighting, and other multidisciplinary areas of product design. He is driven by a passion for experimenting with both industrial and artisanal processes. His approach is rooted in creating pure and honest designs that offer the best possible solution in terms of functionality and quality.

Ilja Huber (geb. 1983) ist ein in Berlin ansässiger Produktdesigner, dessen Arbeit sich auf Möbel, Beleuchtung und andere multidisziplinäre Bereiche des Produktdesigns konzentriert. Er wird von seiner Leidenschaft für das Experimentieren mit industriellen und handwerklichen Verfahren angetrieben. Sein Ansatz basiert auf der Schaffung purer und ehrlicher Designs, die hinsichtlich Funktionalität und Qualität die bestmögliche Lösung bieten.





DESIGNER

## NADINE KÜMMEL

Nadine Kümmel (born 1984) studied interior design and product design at Mainz University of Applied Sciences and Swinburne University of Technology in Melbourne. A master's degree in sustainable design at MCAS Minneapolis College of Art and Design laid the foundation for her sustainable design concepts. Her focus is on classic interior design and space-related products such as furniture, lighting and bathroom accessories. Her work is characterised by the combination of functionality and atmosphere – planning, style and mood intertwine to create a harmonious and coherent design.

Nadine Kümmel (geb. 1984) studierte Innenarchitektur und Produktdesign an der Fachhochschule Mainz sowie an der Swinburne University of Technology in Melbourne. Ein Masterstudium für Sustainable Design am MCAS Minneapolis College of Art and Design legte den Grundstein für ihre nachhaltigen Gestaltungskonzepte. Ihr Fokus liegt auf klassischer Innenarchitektur und raumbezogenen Produkten wie Möbeln, Leuchten und Badaccessoires. Charakteristisch für ihre Arbeit ist die Verbindung von Funktionalität mit Atmosphäre – Planung, Stil und Stimmung greifen ineinander, um ein harmonisches und stimmiges Design zu schaffen.



ELEGANCE MEETS STRENGTH

Our homes are changing – they are increasingly becoming places where we not only live, but also recharge our batteries. The bathroom in particular has taken on a new significance in this transformation: it is a place where we find peace, perform rituals and connect with our inner selves.

With the Ava series we want to enrich this special space. Clean lines and gentle curves give the accessories a subtle elegance that fits effortlessly into any interior. The hand-blown glass objects – from soap dispensers and toothbrush holders to storage jars – combine strength and delicacy, functionality and grace. The highlight of the series is the 3-litre pedal bin. Its sophisticated design makes the bag invisible, elegantly combining hygiene and aesthetics.

ELEGANZ TRIFFT STÄRKE

Unsere Vorstellung vom Zuhause verändert sich – es wird mehr und mehr zu einem Ort, an dem wir Kraft schöpfen und uns selbst begegnen. Besonders das Badezimmer hat in diesem Wandel eine neue Bedeutung gefunden: ein Raum der Ruhe, der Rituale und der Selbstfürsorge.

Mit der Serie Ava möchten wir diesen Ort bereichern. Klare Linien und sanfte Kurven verleihen den Accessoires eine subtile Eleganz, die mühelos in jedes Ambiente passt. Mundgeblasene Glasobjekte – vom Seifenspender bis zur Aufbewahrungsdose – vereinen Stärke und Feinheit, Funktionalität und Anmut. Das Highlight der Serie ist der 3-Liter-Treteimer, dessen raffiniertes Design den Beutel unsichtbar macht – Hygiene und Ästhetik in vollkommener Harmonie.



Ava, Arto



## FROM PLACE TO FAVOURITE SPOT

Some pieces of furniture are like faithful companion – they are always there when you need them. The Porter table by Sebastian Herkner is one such companion. Its round handle invites you to take it with you – out into the garden, to your favourite spot, back into the living room.

Made of powder-coated aluminium, robust yet lightweight, it adapts to any environment. Porter stands for flexibility, for life in motion – and for moments you love to share.

## VOM ORT ZUM LIEBLINGSPLATZ

Manche Möbelstücke gleichen treuen Gefährten – sie sind immer da, wenn man sie braucht. Der Porter Tisch von Sebastian Herkner ist so ein Begleiter. Sein runder Griff wirkt wie eine Einladung, ihn mitzunehmen – hinaus in den Garten, an den Lieblingsplatz, zurück ins Wohnzimmer.

Gefertigt aus pulverbeschichtetem Aluminium, robust und doch leicht, passt er sich jeder Umgebung an. Porter steht für Flexibilität, für das Leben in Bewegung – und für Momente, die man gern teilt.

DESIGNER

## SEBASTIAN HERKNER

German Sebastian Herkner (born 1981) pursued Product Design at HfG Offenbach University of Art and Design. In 2006, Herkner established a studio in his own name. Since then, he's created furniture, lighting and smaller pieces for global brands, as well as undertaking interior architecture projects and museum and exhibition design.

Sebastian Herkner (geb. 1981) aus Deutschland hat Produktdesign an der Hochschule für Gestaltung (HfG) Offenbach studiert. 2006 gründete er in Offenbach sein eigenes Designstudio. Seitdem entwirft er Möbel, Leuchten und kleinere Objekte für weltweite Marken, übernimmt aber auch Innenarchitekturprojekte und Designaufträge für Museen und Ausstellungen.





DESIGNER

## THERESA RAND

Designer Theresa Rand is known for her graceful and highly feminine take on modern interior design. Educated in both her native country Germany and in Copenhagen, where she now lives and works, she has a unique understanding of both the Nordic aesthetic tradition and the German appreciation of function and quality. Her love for simple, functional yet poetic objects with a story to tell is evident in everything she designs, and her desire to create spaces with a warm and inviting feel has given her a preference for classic shapes, natural materials and subtle, elegant colours.

Die Designerin Theresa Rand ist bekannt für ihre anmutigen und stark femininen Interpretationen im modernen Interieur Design. Ausgebildet sowohl in ihrem Geburtsland Deutschland als auch in Kopenhagen, wo sie heute lebt und arbeitet, hat sie ein einzigartiges Verständnis für die nordisch ästhetische Tradition sowie für die deutsche Wertschätzung von Funktion und Qualität. Ihre Liebe für einfache, funktionale aber dennoch poetische Objekte die eine Geschichte erzählen, ist in all ihrer Arbeit ersichtlich. Für ihren Wunsch, Räume mit warmer und einladender Anmutung zu kreieren, bevorzugt sie klassische Formen, natürliche Materialien und raffinierte, elegante Farben.



## THE ART OF JAPAN IN LIGHT

The Sanaka LED outdoor lamp echoes the elegance of Japanese origami art while also evoking traditional tea houses and stone lanterns. Made from recycled polycarbonate, it combines sustainability with high durability and creates a soft, diffused light thanks to its transparency.

The matt white surface makes the light appear like a work of art folded from paper – delicate in appearance, robust in use. With its two-storey roof, Sanaka gives the impression of a small house and brings a touch of Far Eastern tranquillity to the outdoor area.

## DIE KUNST JAPANS IM LICHT

Die Sanaka LED-Outdoorleuchte greift die Eleganz der japanischen Origami-Kunst auf und erinnert zugleich an traditionelle Teehäuser oder Steinlaternen. Aus recyceltem Polycarbonat gefertigt, verbindet sie Nachhaltigkeit mit hoher Beständigkeit und erzeugt durch ihre Transparenz ein sanft diffuses Licht.

Die mattweiße Oberfläche lässt die Leuchte wie aus Papier gefaltet erscheinen – filigran in der Anmutung, robust in der Nutzung. Mit ihrem zweigeschossigen Dach vermittelt Sanaka den Eindruck eines kleinen Hauses und bringt einen Hauch fernöstlicher Ruhe in den Außenbereich.



PRODUCTS

---

# CAPSULE COLLECTION

INTRODUCTION P. 26  
WARM TONES P. 28  
COOL TONES P. 40

## A CELEBRATION OF COLOUR

This season, blomus is expanding its Capsule Collection with bold blues and greens and soft shades of yellow. As the capsule concept – relating to something small and compact – is used in the fashion and design world to describe carefully curated collections of items designed to be used together, harmonised in colour and shape, the blomus Capsule Collection features smaller, decorative objects that centre on just two colour stories – calm blue and green shades, and warm reds, yellows and terracotta.

With this unified focus and the familiar blomus style, you can beautify your home and add a touch of playful colour where you are happy to take a more impulsive approach to your interior design. While the Capsule Collection is available only for a limited time, the pieces are intended to last well beyond the season and to bring you joy for many years to come.

## EIN FEST DER FARBEN

In dieser Saison erweitert blomus die Capsule Collection um kräftiges Blau und Grün und sanfte Nuancen von Gelb. Während das Konzept der Capsule Collection – das sich auf etwas Kleines und Kompaktes bezieht – in der Mode- und Designwelt verwendet wird, um sorgfältig kuratierte Kollektionen von Gegenständen zu beschreiben, die für den gemeinsamen Gebrauch bestimmt sind und in Farbe und Form harmonieren, zeigt die blomus Capsule Collection kleinere, dekorative Objekte, die sich auf zwei Farbwelten konzentrieren: kühle Blau- und Grüntöne und warme Rot-, Gelb- und Terrakottatöne.

Mit diesem einheitlichen Fokus und dem vertrauten blomus-Stil können Sie Ihr Zuhause verschönern und einen Hauch von verspielter Farbe genau dort hinzufügen, wo Sie Ihrer Inneneinrichtung einen impulsiveren Touch verleihen möchten. Die Capsule Collection ist zwar nur für eine begrenzte Zeit erhältlich, aber die Stücke sind so konzipiert, dass sie weit über die Saison hinaus Bestand haben und Ihnen viele Jahre lang Freude bereiten werden.





Doodle



CAPSULE COLLECTION



CAPSULE COLLECTION







## CAPSULE COLLECTION

### TAULO 64868

Set of 2 Tea Towels | Set 2 Geschirrtücher  
 Dimensions B 50 cm, T 70 cm  
 Materials T1 (Organic)  
 Colour White/Transparent Yellow

NEW



### TAULO 64869

Set of 2 Tea Towels | Set 2 Geschirrtücher  
 Dimensions B 50 cm, T 70 cm  
 Materials T1 (Organic)  
 Colour White/Transparent Yellow

NEW



### MOLI 64867

Salt & Peppermill | Salz- und Pfeffermühle  
 Dimensions H 13 cm, Ø 6 cm  
 Materials H13I, ST2  
 Colour Transparent Yellow  
 Features With ceramic grinder  
 Mit Keramikmahlwerk

NEW



### TOKI 68135

Stool, Side Table | Hocker, Beistelltisch  
 Dimensions H 45 cm, B 38 cm, T 26 cm  
 Materials ST2  
 Colour Port  
 Features Max. weight: 95 kg/200 lbs  
 Max. Gewicht: 95 kg

NEW



### FERA 63228

# Set of 2 Side Tables | Set 2 Beistelltische  
 Dimensions H 35 cm, B 35 cm, T 35 cm,  
 H 40 cm, B 40 cm, T 40 cm  
 Materials Sb  
 Colour Port  
 Features Size: S

NEW



### DOODLE 64891

Set of 2 Candle Holders | Set 2 Kerzenhalter  
 Dimensions H 8,5 cm, B 10 cm, T 9,5 cm  
 Materials ST8r  
 Colour Cream Gold  
 Features Suitable for Ø 22 mm candles  
 Passend für Ø 22 mm Kerzen

NEW



### VELA 64846

Candle Holder | Kerzenhalter  
 Dimensions H 9 cm, Ø 11 cm  
 Materials ST2  
 Colour Transparent Yellow  
 Features Suitable for Ø 22 mm candle  
 Passend für Ø 22 mm Kerze, Size: S

NEW



### VELA 64851

Candle Holder | Kerzenhalter  
 Dimensions H 3,5 cm, Ø 16 cm  
 Materials ST2  
 Colour New Wheat  
 Features Suitable for Ø 22 mm candle  
 Passend für Ø 22 mm Kerze, Size: M

NEW



### VELA 67153

Candle Holder | Kerzenhalter  
 Dimensions H 3,5 cm, Ø 27 cm  
 Materials ST2  
 Colour Amber Brown  
 Features Suitable for Ø 22 mm candles  
 Passend für Ø 22 mm Kerzen



**VELA 67150**

Candle Holder | Kerzenhalter  
 Dimensions H 4 cm, Ø 9 cm  
 Materials ST2  
 Colour Brandy Brown  
 Features Suitable for Ø 22 mm candle  
 Passend für Ø 22 mm Kerze,  
 Size: S

**67150**  
Brandy Brown



**67151**  
Amber Brown



**VELA 67143**

Candle Holder | Kerzenhalter  
 Dimensions H 3 cm, Ø 14,5 cm  
 Materials ST2  
 Colour Brandy Brown  
 Features Suitable for Ø 22 mm candle  
 Passend für Ø 22 mm Kerze,  
 Size: M

**67143**  
Brandy Brown



**67144**  
Amber Brown



**CEOLA 64812**

Vase | Vase  
 Dimensions H 13 cm, Ø 8 cm  
 Materials ST2  
 Colour Transparent Yellow

**64812 - NEW**  
Transparent Yellow



**64813 - NEW**  
New Wheat



**64635**  
Amber Brown



**CEOLA 64814**

Vase | Vase  
 Dimensions H 18 cm, Ø 8 cm  
 Materials ST2  
 Colour Transparent Yellow

**64814 - NEW**  
Transparent Yellow



**64815 - NEW**  
New Wheat



**64638**  
Amber Brown



**CEOLA 64817**

Vase | Vase  
 Dimensions H 19 cm, Ø 14 cm  
 Materials ST2  
 Colour Transparent Yellow

**64817 - NEW**  
Transparent Yellow



**64818 - NEW**  
New Wheat



**64641**  
Amber Brown



**CEOLA 64819**

Vase | Vase  
 Dimensions H 21 cm, Ø 11 cm  
 Materials ST2  
 Colour Cream Gold

**64819 - NEW**  
Cream Gold



**64644**  
Indian Tan



CAPSULE COLLECTION

**CEOLA 64821**

Vase | Vase  
 Dimensions H 25 cm, Ø 13 cm  
 Materials ST2  
 Colour Cream Gold



64821 - NEW  
 Cream Gold



64646  
 Indian Tan

**CEOLA 64828**

Set of 3 Vases | Set 3 Vasen  
 Dimensions H 8 cm, Ø 8 cm, H 9 cm, Ø 5,5 cm, H 10 cm, Ø 6 cm  
 Materials ST2  
 Colour Transparent Yellow, Cream Gold, New Wheat



NEW

**COLORA 64650**

Vase | Vase  
 Dimensions H 15 cm, Ø 10,5 cm  
 Materials ST2  
 Colour Indian Tan  
 Features Soft touch, Size: S



64650  
 Indian Tan



64651  
 Amber Brown



**COLORA 64654**

Vase | Vase  
 Dimensions H 20 cm, Ø 14 cm  
 Materials ST2  
 Colour Indian Tan  
 Features Soft touch, Size: L



64654  
 Indian Tan



64655  
 Amber Brown



**LETA 64856**

Vase | Vase  
 Dimensions H 13 cm, Ø 13 cm  
 Materials ST2  
 Colour Transparent Yellow  
 Features Size: M



64856  
 Transparent Yellow



64857  
 New Wheat



**LETA 64858**

Vase | Vase  
 Dimensions H 15 cm, Ø 15 cm  
 Materials ST2  
 Colour Transparent Yellow  
 Features Size: L



64858  
 Transparent Yellow



64859  
 New Wheat



NEW

NEW



**LITO 64879**

Lantern | Laterne  
 Dimensions H 10 cm, Ø 13 cm  
 Materials Sb  
 Colour New Wheat  
 Features Size: XS

**64879 - NEW**  
New Wheat



**64656**  
Indian Tan



**LITO 64881**

Lantern | Laterne  
 Dimensions H 17 cm, Ø 20 cm  
 Materials Sb  
 Colour New Wheat  
 Features Size: S

**64881 - NEW**  
New Wheat



**64659**  
Indian Tan



**LITO 64877**

Bowl | Schale  
 Dimensions H 9 cm, Ø 25 cm  
 Materials Sb  
 Colour New Wheat  
 Features Size: M

**64877 - NEW**  
New Wheat



**64701**  
Indian Tan



**KASANE 67590**

Storage Box | Aufbewahrungsbox  
 Dimensions H 14 cm, B 25 cm, T 19,5 cm  
 Materials H12  
 Colour New Wheat  
 Features Stackable  
 Stapelbar, Size: S

NEW



**KASANE 67595**

Storage Box | Aufbewahrungsbox  
 Dimensions H 14 cm, B 25 cm, T 39 cm  
 Materials H12  
 Colour New Wheat  
 Features Stackable  
 Stapelbar, Size: M

NEW



**KASANE 67600**

Storage Box | Aufbewahrungsbox  
 Dimensions H 24,5 cm, B 25 cm, T 39 cm  
 Materials H12  
 Colour New Wheat  
 Features Stackable  
 Stapelbar, Size: L

NEW



## CAPSULE COLLECTION

### KASANE 67605

Tray | Tablett  
 Dimensions H 3 cm, B 25 cm, B 39 cm  
 Materials H12  
 Colour New Wheat  
 Features Stackable  
 Stapelbar, Size: L

NEW



### KASANE 67610

Tray | Tablett  
 Dimensions H 3 cm, B 25 cm, B 19,5 cm  
 Materials H12  
 Colour New Wheat  
 Features Stackable  
 Stapelbar, Size: S

NEW



### KAGO 64963

Storage Basket | Aufbewahrungskorb  
 Dimensions H 14 cm, B 29 cm, T 21 cm  
 Materials S1b  
 Colour New Wheat  
 Features Stackable, oval  
 Stapelbar, oval, Size: S

NEW



### KAGO 64968

Storage Basket | Aufbewahrungskorb  
 Dimensions H 17 cm, B 37 cm, T 27 cm  
 Materials S1b  
 Colour New Wheat  
 Features Stackable, oval  
 Stapelbar, oval, Size: M

NEW



### KAGO 64973

Storage Basket | Aufbewahrungskorb  
 Dimensions H 14 cm, B 29 cm, T 21 cm  
 Materials S1b  
 Colour New Wheat  
 Features Stackable, square  
 Stapelbar, eckig, Size: S

NEW



### KAGO 64978

Storage Basket | Aufbewahrungskorb  
 Dimensions H 17 cm, B 37 cm, T 27 cm  
 Materials S1b  
 Colour New Wheat  
 Features Stackable, square  
 Stapelbar, eckig, Size: M

NEW



### PONTO 67396

Set of 4 Wall Hooks | Set 4 Wandhaken  
 Dimensions T 4,5 cm, Ø 8,5 cm, T 4,5 cm, Ø 5 cm  
 Materials ST3  
 Colour Mocha Mousse

NEW



### PONTO 67398

Set of 4 Wall Hooks | Set 4 Wandhaken  
 Dimensions T 4,5 cm, Ø 8,5 cm, T 4,5 cm, Ø 5 cm  
 Materials ST3  
 Colour New Wheat, Brandy Brown, Mocha Mousse, Nomad

NEW



**SONO 66896**

Toilet Brush | WC-Bürste  
 Dimensions H 39 cm, Ø 11 cm  
 Materials SSp, ST2, K3, K4  
 Colour Amber Brown

NEW



**SONO 66897**

Pedal Bin | Treteimer  
 Dimensions H 25,5 cm, T 24 cm, Ø 20 cm, V 3 l  
 Materials K3, K4  
 Colour Amber Brown  
 Features Soft Close

NEW



**SONO 66898**

Tray | Tablett  
 Dimensions H 2,5 cm, B 10 cm, T 19 cm  
 Materials ST2  
 Colour Amber Brown

NEW



**SONO 67235**

Soap Dispenser | Seifenspender  
 Dimensions H 14 cm, T 9,5 cm, Ø 8,5 cm, V 250 ml  
 Materials ST2, K3, K4  
 Colour Amber Brown



**SONO 67236**

Tumbler | Zahnpfutzbecher  
 Dimensions H 11 cm, Ø 8,5 cm  
 Materials ST2  
 Colour Amber Brown



**KORIE 66878**

Laundry Basket | Wäschesammler  
 Dimensions H 55 cm, Ø 40 cm  
 Materials K3  
 Colour Amber Brown

NEW



**FRAGA 69051**

Scented Candle | Duftkerze  
 Dimensions H 8 cm, Ø 6,5 cm  
 Materials ST4, W1  
 Features Fragrance: Bergamot Orange,  
 24 h Burning Time  
 Duft: Bergamot Orange,  
 Brenndauer 24 h



**FRAGA 69052**

Scented Candle | Duftkerze  
 Dimensions H 11 cm, Ø 9 cm  
 Materials ST4, W1  
 Features Fragrance: Bergamot Orange,  
 55 h Burning Time  
 Duft: Bergamot Orange,  
 Brenndauer 55 h



# CAPSULE COLLECTION

## ARTO 67425

Bath Towel | Badetuch  
 Dimensions B 70 cm, T 140 cm  
 Materials T1 (ORGANIC)  
 Colour White/Transparent Yellow  
 Features 100 % Organic Cotton, Terry Cloth, 600g/m<sup>2</sup> | 100 % Bio-Baumwolle, Frottee 600 g/m<sup>2</sup>



67425 - NEW  
White/Transparent Yellow



67339  
Moonbeam/Amber Brown



67341  
Micro Chip/Tan



67426 - NEW  
White/Transparent Yellow



67340  
Moonbeam/Amber Brown



67342  
Micro Chip/Tan



## ARTO 67429

Towel | Handtuch  
 Dimensions B 50 cm, T 100 cm  
 Materials T1 (ORGANIC)  
 Colour White/Transparent Yellow  
 Features 100 % Organic Cotton, Terry Cloth, 600g/m<sup>2</sup> | 100 % Bio-Baumwolle, Frottee 600 g/m<sup>2</sup>



67429 - NEW  
White/Transparent Yellow



67430 - NEW  
White/Transparent Yellow



67346  
Moonbeam/Amber Brown



67347  
Micro Chip/Tan



## ARTO 67433

Set of 2 Guest Hand Towel | Set 2 Gästehandtücher  
 Dimensions B 30 cm, T 50 cm  
 Materials T1 (ORGANIC)  
 Colour White/Transparent Yellow  
 Features 100 % Organic Cotton, Terry Cloth, 600g/m<sup>2</sup> | 100 % Bio-Baumwolle, Frottee 600 g/m<sup>2</sup>



67433 - NEW  
White/Transparent Yellow



67434 - NEW  
White/Transparent Yellow



67350  
Moonbeam/Amber Brown



67351  
Micro Chip/Tan







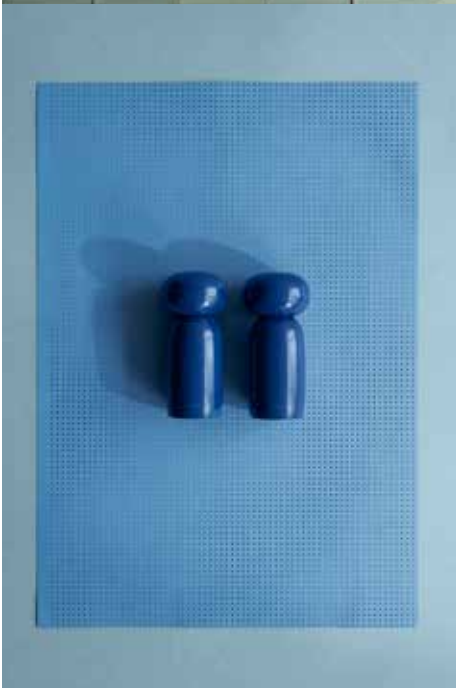
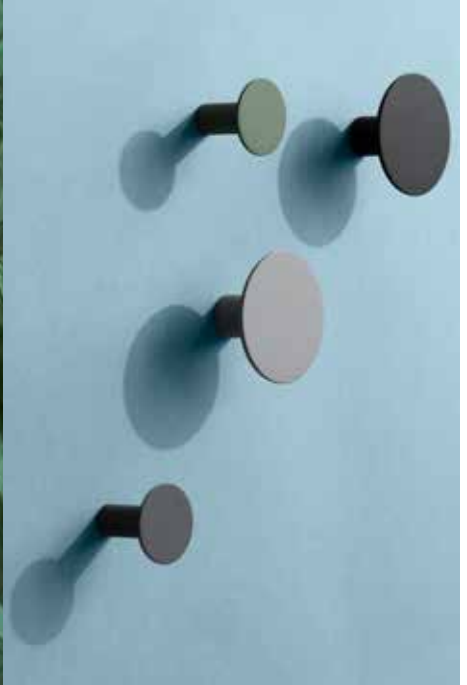



CAPSULE COLLECTION





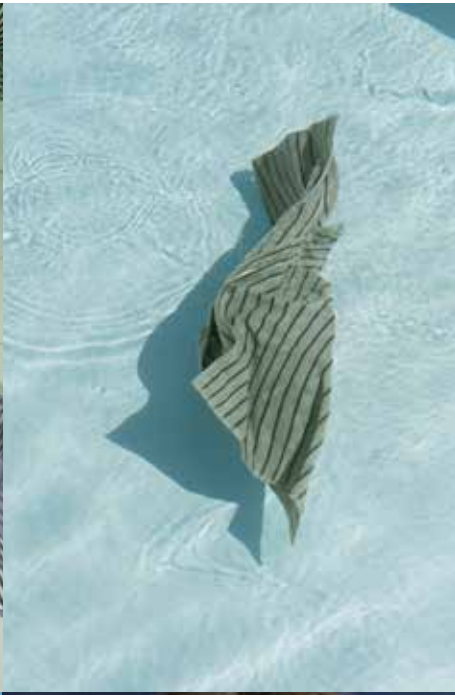

# CAPSULE COLLECTION

## TAULO 64870

Set of 2 Tea Towels | Set 2 Geschirrtücher  
 Dimensions B 50 cm, T 70 cm  
 Materials T1 (Organic)  
 Colour White/Mazarine Blue

NEW



## TAULO 64871

Set of 2 Tea Towels | Set 2 Geschirrtücher  
 Dimensions B 50 cm, T 70 cm  
 Materials T1 (Organic)  
 Colour White/Mazarine Blue

NEW

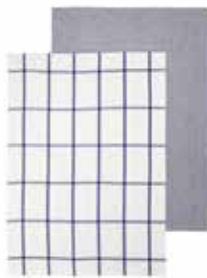

## MOLI 64866

Salt & Peppermill | Salz- und Pfeffermühle  
 Dimensions H 13 cm, Ø 6 cm  
 Materials H13I, ST2  
 Colour Mazarine Blue  
 Features With ceramic grinder  
 Mit Keramikmahlwerk

NEW



## TOKI 68134

Stool, Side Table | Hocker, Beistelltisch  
 Dimensions H 45 cm, B 38 cm, T 26 cm  
 Materials ST2  
 Colour Mazarine Blue  
 Features max. weight: 95kg/200 lbs  
 Max. Gewicht: 95 kg

NEW



## DOODLE 64892

Set of 2 Candle Holders | Set 2 Kerzenhalter  
 Dimensions H 8,5 cm, B 10 cm, T 9,5 cm  
 Materials ST8r  
 Colour Mazarine Blue  
 Features Suitable for Ø 22 mm candles  
 Passend für Ø 22 mm Kerzen

NEW



## VELA 64845

Candle Holder | Kerzenhalter  
 Dimensions H 9 cm, Ø 11 cm  
 Materials ST2  
 Colour Mazarine Blue  
 Features Suitable for Ø 22 mm candle  
 Passend für Ø 22 mm Kerze, Size: S

NEW



## VELA 64850

Candle Holder | Kerzenhalter  
 Dimensions H 3,5 cm, Ø 16 cm  
 Materials ST2  
 Colour Ocean Cavern  
 Features Suitable for Ø 22 mm candle  
 Passend für Ø 22 mm Kerze, Size: M

NEW



## VELA 67149

Candle Holder | Kerzenhalter  
 Dimensions H 4 cm, Ø 9 cm  
 Materials ST2  
 Colour Desert Sage  
 Features Suitable for Ø 22 mm candle  
 Passend für Ø 22 mm Kerze, Size: S



## VELA 67142

Candle Holder | Kerzenhalter  
 Dimensions H 3 cm, Ø 14,5 cm  
 Materials ST2  
 Colour Desert Sage  
 Features Suitable for Ø 22 mm candle  
 Passend für Ø 22 mm Kerze, Size: M



**DUASIS 64885**

Vase | Vase  
 Dimensions H 21 cm, B 18 cm, T 10 cm  
 Materials Gf  
 Colour Ocean Cavern  
 Features: Size: S

**64885**  
 Ocean Cavern



NEW



**64886**  
 Agave Green



**DUASIS 64888**

Vase | Vase  
 Dimensions H 28 cm, B 18 cm, T 10 cm  
 Materials Gf  
 Colour Ocean Cavern  
 Features: Size: M

**64888**  
 Ocean Cavern



NEW



**64889**  
 Agave Green



**CEOLA 64636**

Vase | Vase  
 Dimensions H 13 cm, Ø 8 cm  
 Materials ST2  
 Colour Desert Sage

**64636**  
 Desert Sage



**64637**  
 Tradewinds



**CEOLA 64816**

Vase | Vase  
 Dimensions H 18 cm, Ø 8 cm  
 Materials ST2  
 Colour Rain Forest

**64816 - NEW**  
 Rain Forest



**64639**  
 Desert Sage



**64640**  
 Tradewinds



**CEOLA 64642**

Vase | Vase  
 Dimensions H 19 cm, Ø 14 cm  
 Materials ST2  
 Colour Desert Sage

**64642**  
 Desert Sage



**64643**  
 Tradewinds



**CEOLA 64820**

Vase | Vase  
 Dimensions H 21 cm, Ø 11 cm  
 Materials ST2  
 Colour Rain Forest

**64820 - NEW**  
 Rain Forest



**64645**  
 Agave Green



# CAPSULE COLLECTION

## CEOLA 64822

Vase | Vase  
 Dimensions H 25 cm, Ø 13 cm  
 Materials ST2  
 Colour Rain Forest



64822 - NEW  
 Rain Forest



64647  
 Agave Green



## CEOLA 64827

Set of 3 Vases | Set 3 Vasen  
 Dimensions H 8 cm, Ø 8 cm, H 9 cm, Ø 5,5 cm, H 10 cm, Ø 6 cm  
 Materials ST2  
 Colour Parisian Blue, Mazarine Blue, Ocean Cavern



NEW

## COLORA 64829

Vase | Vase  
 Dimensions H 15 cm, Ø 10,5 cm  
 Materials ST2  
 Colour Mazarine Blue  
 Features Soft touch, Size: S



64829 - NEW  
 Mazarine Blue



64648  
 Desert Sage



64649  
 Tradewinds



## COLORA 64830

Vase | Vase  
 Dimensions H 20 cm, Ø 14 cm  
 Materials ST2  
 Colour Mazarine Blue  
 Features Soft touch, Size: L



64830 - NEW  
 Mazarine Blue



64652  
 Desert Sage



64653  
 Tradewinds



## LYVA 64882

Lantern | Laterne  
 Dimensions H 17 cm, Ø 25 cm  
 Materials Sb  
 Colour Ocean Cavern  
 Features Size: S

NEW



## LYVA 64883

Lantern | Laterne  
 Dimensions H 26,5, Ø 31 cm  
 Materials Sb  
 Colour Ocean Cavern  
 Features Size: M

NEW



## LITO LED XS

In-/Outdoor use | In-/Outdoorbenutzung

Battery operated | Akkubetrieb

USB-C Charging | USB-C Aufladung

Operation time | Brenndauer: 7-35 h

Luminous flux | Lichtstrom: 140 lm

Output | Leistung: 1 W

Voltage | Spannung: DC 3.7 V

Protection class | Schutzklasse: III

Water tightness | Wasserdichtigkeit: IP 54

Luminous colour | Lichtfarbe: 2700-4000K

Input: DC5V/1A

Charging Time | Ladezeit: 2.5 h

**LITO 64878**

Lantern | Laterne  
 Dimensions H 10 cm, Ø 13 cm  
 Materials Sb  
 Colour Ocean Cavern  
 Features Size: XS



**64878 - NEW**  
Ocean Cavern



**64657**  
Tradewinds



**64658**  
Agave Green



**LITO 64880**

Lantern | Laterne  
 Dimensions H 17 cm, Ø 20 cm  
 Materials Sb  
 Colour Ocean Cavern  
 Features Size: S



**64880 - NEW**  
Ocean Cavern



**64660**  
Tradewinds



**64661**  
Agave Green



**LITO 64876**

Bowl | Schale  
 Dimensions H 9 cm, Ø 25 cm  
 Materials Sb  
 Colour Ocean Cavern  
 Features Size: M



**64876 - NEW**  
Ocean Cavern



**64702**  
Tradewinds



**64703**  
Agave Green



**KASANE 67582**

Storage Box | Aufbewahrungsbox  
 Dimensions H 14 cm, B 25 cm, T 19,5 cm  
 Materials H12  
 Colour Rain Forest  
 Features Stackable  
 Stapelbar, Size: S



**67582**  
Rain Forest



NEW

**67589**  
Mazarine Blue



**LITO LED 67480**

Mobile LED Lamp | Mobile LED-Leuchte  
 Dimensions H 12 cm, Ø 13,5 cm  
 Materials Ab, Sb, K4  
 Colour Ocean Cavern  
 Features 3 light colours, infinitely dimmable | 3 Lichtfarben, stufenlos dimmbar, Size: XS

NEW



**67480**  
Ocean Cavern



**67481**  
Agave Green



**KASANE 67583**

Storage Box | Aufbewahrungsbox  
 Dimensions H 14 cm, B 25 cm, T 39 cm  
 Materials H12  
 Colour Rain Forest  
 Features Stackable  
 Stapelbar, Size: M



**67583**  
Rain Forest



NEW

**67594**  
Mazarine Blue





# CAPSULE COLLECTION

## KASANE 67584

Storage Box | Aufbewahrungsbox  
 Dimensions H 24,5 cm, B 25 cm, T 39 cm  
 Materials H12  
 Colour Rain Forest  
 Features Stackable  
 Stapelbar, Size: L

67584  
Rain Forest



NEW



67599  
Mazarine Blue



## KASANE 67585

Tray | Tablett  
 Dimensions H 3 cm, B 25 cm, B 39 cm  
 Materials H12  
 Colour Rain Forest  
 Features Stackable  
 Stapelbar, Size: L

67585  
Rain Forest



NEW



67604  
Mazarine Blue



## KASANE 67586

Tray | Tablett  
 Dimensions H 3 cm, B 25 cm, B 19,5 cm  
 Materials H12  
 Colour Rain Forest  
 Features Stackable  
 Stapelbar, Size: S

67586  
Rain Forest



NEW



67609  
Mazarine Blue



## KAGO 64962

Storage Basket | Aufbewahrungskorb  
 Dimensions H 14 cm, B 29 cm, T 21 cm  
 Materials S1b  
 Colour Mazarine Blue  
 Features Stackable, oval  
 Stapelbar, oval, Size: S

64962  
Mazarine Blue



NEW



64986  
Rain Forest



## KAGO 64967

Storage Basket | Aufbewahrungskorb  
 Dimensions H 17 cm, B 37 cm, T 27 cm  
 Materials S1b  
 Colour Mazarine Blue  
 Features Stackable, oval  
 Stapelbar, oval, Size: M

64967  
Mazarine Blue



NEW



64987  
Rain Forest



## KAGO 64972

Storage Basket | Aufbewahrungskorb  
 Dimensions H 14 cm, B 29 cm, T 21 cm  
 Materials S1b  
 Colour Mazarine Blue  
 Features Stackable, square  
 Stapelbar, eckig, Size: S

64972  
Mazarine Blue



NEW

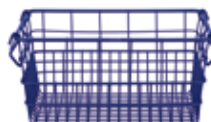

64988  
Rain Forest



**KAGO 64977**

Storage Basket | Aufbewahrungskorb  
 Dimensions H 17 cm, B 37 cm, T 27 cm  
 Materials S1b  
 Colour Mazarine Blue  
 Features Stackable, square  
 Stapelbar, eckig, Size: M

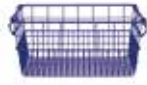

64977  
Mazarine Blue



64989  
Rain Forest

NEW

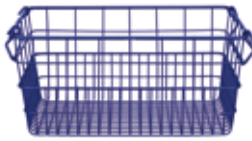

**PONTO 67397**

Set of 4 Wall Hooks | Set 4 Wandhaken  
 Dimensions T 4,5 cm, Ø 8,5 cm, T 4,5 cm, Ø 5 cm  
 Materials ST3  
 Colour Rain Forest, Micro Chip,  
 Desert Sage, Tradewinds

NEW



**SONO 67549**

Soap Dispenser | Seifenspender  
 Dimensions H 14 cm, T 9,5 cm, Ø 8,5 cm, V 250 ml  
 Materials ST2, K3, K4  
 Colour Mazarine Blue

NEW



**SONO 67550**

Tumbler | Zahnputzbecher  
 Dimensions H 11 cm, Ø 8,5 cm  
 Materials ST2  
 Colour Mazarine Blue

NEW



**SONO 67551**

Toilet Brush | WC-Bürste  
 Dimensions H 39 cm, Ø 11 cm  
 Materials SSp, ST2, K3, K4  
 Colour Mazarine Blue

NEW



**SONO 67552**

Pedal Bin | Treteimer  
 Dimensions H 25,5 cm, T 24 cm, Ø 20 cm, V 3 l  
 Materials K3, K4  
 Colour Mazarine Blue  
 Features Soft Close

NEW



**SONO 67553**

Tray | Tablett  
 Dimensions H 2,5 cm, B 10 cm, T 19 cm  
 Materials ST2  
 Colour Mazarine Blue

NEW



# CAPSULE COLLECTION

## KORIE 66879

Laundry Basket | Wäschekorb  
 Dimensions H 55 cm, Ø 40 cm  
 Materials K3  
 Colour Mazarine Blue

NEW



## VALOA 65295

Scented Candle | Duftkerze  
 Dimensions H 7,5 cm, Ø 7,5 cm  
 Materials Gf, W1  
 Colour Agave Green  
 Features Fragrance: Fig Tree - Lime - No. 05,  
 30h Burning Time | Duft: Fig Tree -  
 Lime - No. 05, Brenndauer 30 h, Size: S



## VALOA 65296

Scented Candle | Duftkerze  
 Dimensions H 9,5 cm, Ø 9 cm  
 Materials Gf, W1  
 Colour Agave Green  
 Features Fragrance: Fig Tree - Lime - No. 05,  
 45h Burning Time | Duft: Fig Tree -  
 Lime - No. 05, Brenndauer 45 h, Size: L



## ARTO 67427

Bath Towel | Badetuch  
 Dimensions B 70 cm, T 140 cm  
 Materials T1 (ORGANIC)  
 Colour Moonbeam/Mazarine Blue  
 Features 100 % Organic Cotton, Terry Cloth,  
 600g/m² | 100 % Bio-Baumwolle,  
 Frottee 600 g/m²



67427 - NEW  
 Moonbeam/Mazarine Blue



67343  
 Desert Sage/Agave Green



67428 - NEW  
 Moonbeam/Mazarine Blue



67344  
 Desert Sage/Agave Green



## ARTO 67431

Towel | Handtuch  
 Dimensions B 50 cm, T 100 cm  
 Materials T1 (ORGANIC)  
 Colour Moonbeam/Mazarine Blue  
 Features 100 % Organic Cotton, Terry Cloth,  
 600g/m² | 100 % Bio-Baumwolle,  
 Frottee 600 g/m²

NEW



## ARTO 67432

Towel | Handtuch  
 Dimensions B 50 cm, T 100 cm  
 Materials T1 (ORGANIC)  
 Colour Moonbeam/Mazarine Blue  
 Features 100 % Organic Cotton, Terry Cloth,  
 600g/m² | 100 % Bio-Baumwolle,  
 Frottee 600 g/m²

NEW



## ARTO 67348

Hand Towel | Handtuch  
 Dimensions B 50 cm, T 100 cm  
 Materials T1 (ORGANIC)  
 Colour Desert Sage/Agave Green  
 Features 100% Organic Cotton, Terry Cloth,  
 600g/m² | 100% Bio-Baumwolle,  
 Frottee 600 g/m²







**ARTO 67435**

Set of 2 Guest Hand Towel | Set 2 Gästehandtücher  
 Dimensions B 30 cm, T 50 cm  
 Materials T1 (ORGANIC)  
 Colour Moonbeam/Mazarine Blue  
 Features 100 % Organic Cotton, Terry Cloth,  
 600g/m<sup>2</sup> | 100 % Bio-Baumwolle,  
 Frottee 600 g/m<sup>2</sup>

NEW



**ARTO 67436**

Set of 2 Guest Hand Towel | Set 2 Gästehandtücher  
 Dimensions B 30 cm, T 50 cm  
 Materials T1 (ORGANIC)  
 Colour Moonbeam/Mazarine Blue  
 Features 100 % Organic Cotton, Terry Cloth,  
 600g/m<sup>2</sup> | 100 % Bio-Baumwolle,  
 Frottee 600 g/m<sup>2</sup>

NEW



**ARTO 67352**

Set of 2 Guest Towels | Set 2 Gästehandtücher  
 Dimensions B 30 cm, T 50 cm  
 Materials T1 (ORGANIC)  
 Colour Desert Sage/Agave Green  
 Features 100% Organic Cotton, Terry Cloth,  
 600g/m<sup>2</sup> | 100% Bio-Baumwolle,  
 Frottee 600 g/m<sup>2</sup>





PRODUCTS

---

# DINING ESSENTIALS

TABLEWARE	P. 54
CUTLERY	P. 88
GLASSWARE	P. 92
TEXTILES	P. 100
DINING ACCESSORY	P. 104
KITCHEN TOOL	P. 114



**MAKOTO – DESIGN BY CARSTEN GOLLNICK**

The MAKOTO collection by Carsten Gollnick stands for sincerity and simplicity. Clear geometries and soft, nature-inspired surfaces meet matt glazes that exude calm and clarity. Each piece is unique, with small variations giving it its character. Subtle bases lend plates, bowls and vases a floating lightness – for a table culture that combines minimalism and enjoyment. The tableware series is dishwasher safe and microwave safe.

**MAKOTO – DESIGN VON CARSTEN GOLLNICK**

Die Kollektion MAKOTO von Carsten Gollnick steht für Aufrichtigkeit und Schlichtheit. Klare Geometrien und sanfte, naturinspirierte Oberflächen treffen auf matte Glasuren, die Ruhe und Klarheit verströmen. Jedes Stück ist ein Unikat, kleine Abweichungen machen seinen Charakter aus. Dezente Standfüße verleihen Tellern, Schalen und Vasen eine schwebende Leichtigkeit – für eine Tischkultur, die Minimalismus und Genuss verbindet. Die Geschirrsreihe ist spülmaschinen- und mikrowellengeeignet.



Find out more about the MAKOTO series.  
Erfahren Sie mehr über die MAKOTO Serie.

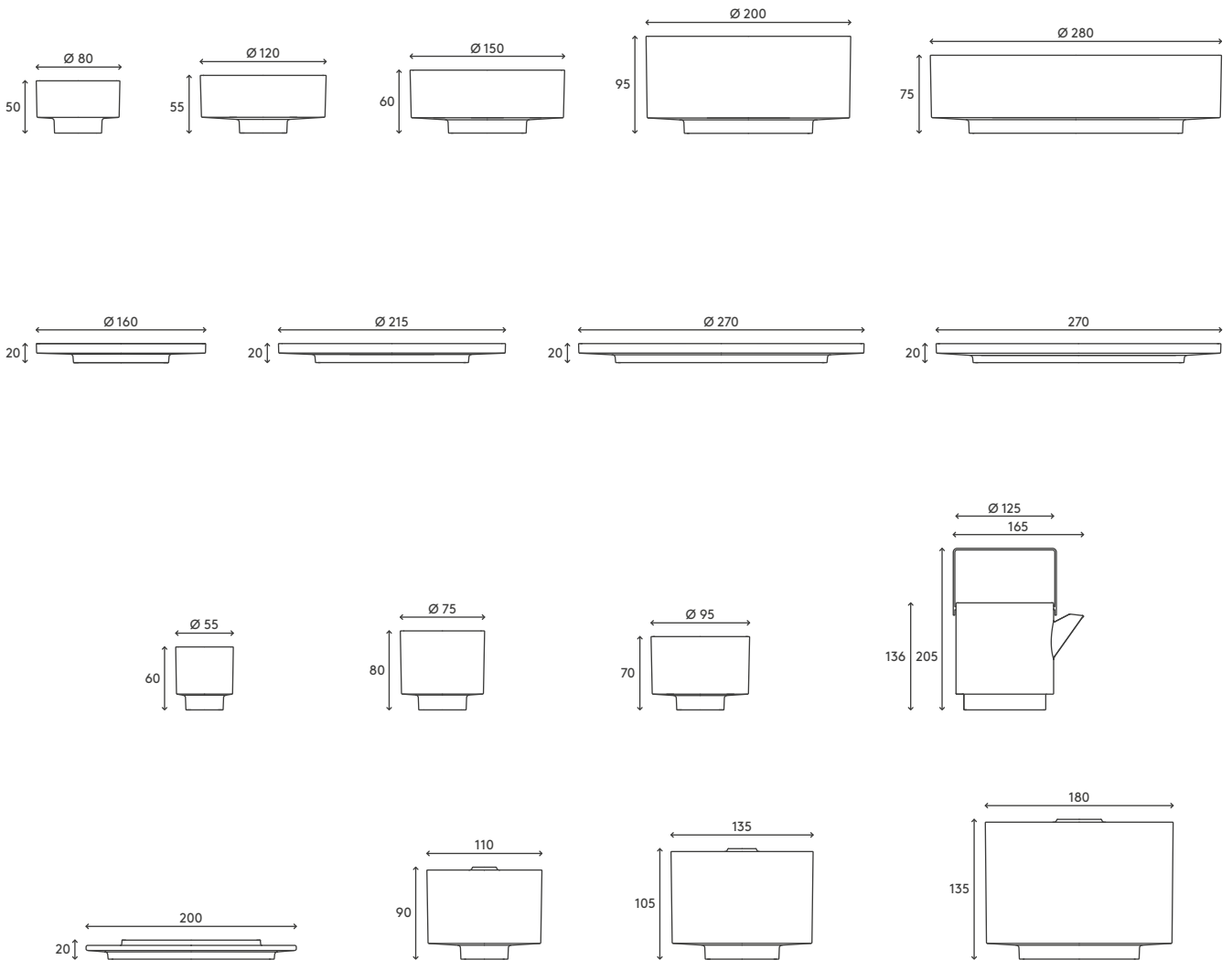

**MAKOTO 64922**

# Dinner Plate | Speiseteller  
 Dimensions H 2 cm, Ø 27 cm  
 Materials ST2  
 Colour Moonbeam

NEW

64922  
Moonbeam



64923  
Elephant Skin



**MAKOTO 64924**

# Desert Plate | Dessertteller  
 Dimensions H 2 cm, Ø 21,5 cm  
 Materials ST2  
 Colour Moonbeam

NEW

64924  
Moonbeam



64925  
Elephant Skin



# Pallet delivery only. Nur Palettenversand.

DINING ESSENTIALS

**MAKOTO 64926**

# Side Plate | Beilagenteller  
 Dimensions H 2 cm, Ø 16 cm  
 Materials ST2  
 Colour Moonbeam

NEW



**MAKOTO 64928**

# Bowl | Schale  
 Dimensions H 6 cm, Ø 15 cm  
 Materials ST2  
 Colour Moonbeam  
 Features Size: M

NEW



**MAKOTO 64930**

# Bowl | Schale  
 Dimensions H 5,5 cm, Ø 12 cm  
 Materials ST2  
 Colour Moonbeam  
 Features Size: S

NEW



**MAKOTO 64932**

# Bowl | Schale  
 Dimensions H 5 cm, Ø 8 cm  
 Materials ST2  
 Colour Moonbeam  
 Features Size: XS

NEW



**MAKOTO 64934**

# Tea Cup | Teetasse  
 Dimensions H 7 cm, Ø 9,5 cm, V 280 ml  
 Materials ST2  
 Colour Moonbeam

NEW

64934  
Moonbeam



64935  
Elephant Skin



**MAKOTO 64936**

# Espresso Cup | Espressotasse  
 Dimensions H 6 cm, Ø 5,5 cm, V 55 ml  
 Materials ST2  
 Colour Moonbeam

NEW

64936  
Moonbeam



64937  
Elephant Skin



**MAKOTO 64938**

# Coffee Cup | Kaffeetasse  
 Dimensions H 7,5 cm, Ø 8 cm, V 215 ml  
 Materials ST2  
 Colour Moonbeam

NEW

64938  
Moonbeam



64939  
Elephant Skin



**MAKOTO 64940**

# Vase | Vase  
 Dimensions H 9 cm, Ø 11 cm  
 Materials ST2  
 Colour Moonbeam  
 Features Size: S

NEW

64940  
Moonbeam



64941  
Elephant Skin



**MAKOTO 64942**

# Vase | Vase  
 Dimensions H 10,5 cm, Ø 13,5 cm  
 Materials ST2  
 Colour Moonbeam  
 Features Size: M

NEW

64942  
Moonbeam



64943  
Elephant Skin



# Pallet delivery only. Nur Palettenversand.

# DINING ESSENTIALS

## MAKOTO 64944

# Vase | Vase  
 Dimensions H 13,5 cm, Ø 18 cm  
 Materials ST2  
 Colour Moonbeam  
 Features Size: L



NEW



## MAKOTO 64946

# Servingplate | Servierplatte  
 Dimensions H 2 cm, B 27 cm, T 13 cm  
 Materials ST2  
 Colour Moonbeam



NEW



## MAKOTO 64948

# Tray Saucer | Servier Untertasse  
 Dimensions H 2 cm, B 20 cm, T 12 cm  
 Materials ST2  
 Colour Moonbeam



NEW



## MAKOTO 64950

# Bowl | Salatschüssel  
 Dimensions H 7,5 cm, Ø 28 cm  
 Materials ST2  
 Colour Moonbeam



NEW



## MAKOTO 64952

# Serving Bowl | Servierschale  
 Dimensions H 9,5 cm, Ø 20 cm  
 Materials ST2  
 Colour Moonbeam



NEW



## MAKOTO 64954

# Teapot | Teekanne  
 Dimensions H 20,5 cm, B 16,5 cm,  
 T 12,5 cm, V 980 ml  
 Materials ST2, SSm, K4  
 Colour Moonbeam



NEW







# Pallet delivery only. Nur Palettenversand.



**VAHLO – DESIGN BY SEBASTIAN HERKNER**

Simple, elegant and soft – these words perfectly describe the VAHLO tableware series by German designer Sebastian Herkner. The rounded corners make the design special and set it apart from classic round crockery collections. The series, consisting of eleven different products, is made of high-quality stoneware, which is refined by the glossy glaze and presents the simple colours Moonbeam and Mirage Gray in an elegant sheen. VAHLO is fired at 1200°C and consists of different sized plates, bowls, salad bowls, a mug and a set of two coffee cups. The tableware series is dishwasher safe and microwave safe.

**VAHLO – DESIGN VON SEBASTIAN HERKNER**

Schlicht, elegant und weich – diese Worte beschreiben die Geschirrserie VAHLO vom deutschen Designer Sebastian Herkner perfekt. Die abgerundeten Ecken machen das Design besonders und heben es von klassisch runden Geschirrkollektionen ab. Die aus elf unterschiedlichen Produkten bestehende Serie ist aus hochwertigem Steingut gefertigt, welches durch die glänzende Glasur veredelt wird und die schlichten Farben Moonbeam und Mirage Gray in einem eleganten Glanz präsentieren. VAHLO wird bei 1200°C gebrannt und besteht aus verschiedenen großen Tellern, Schalen, Salatschüsseln, einem Becher und einem 2er Set Kaffeetassen. Die Geschirrserie ist spülmaschinen- und mikrowellengeeignet.



Find out more about the VAHLO series.  
Erfahren Sie mehr über die VAHLO Serie.

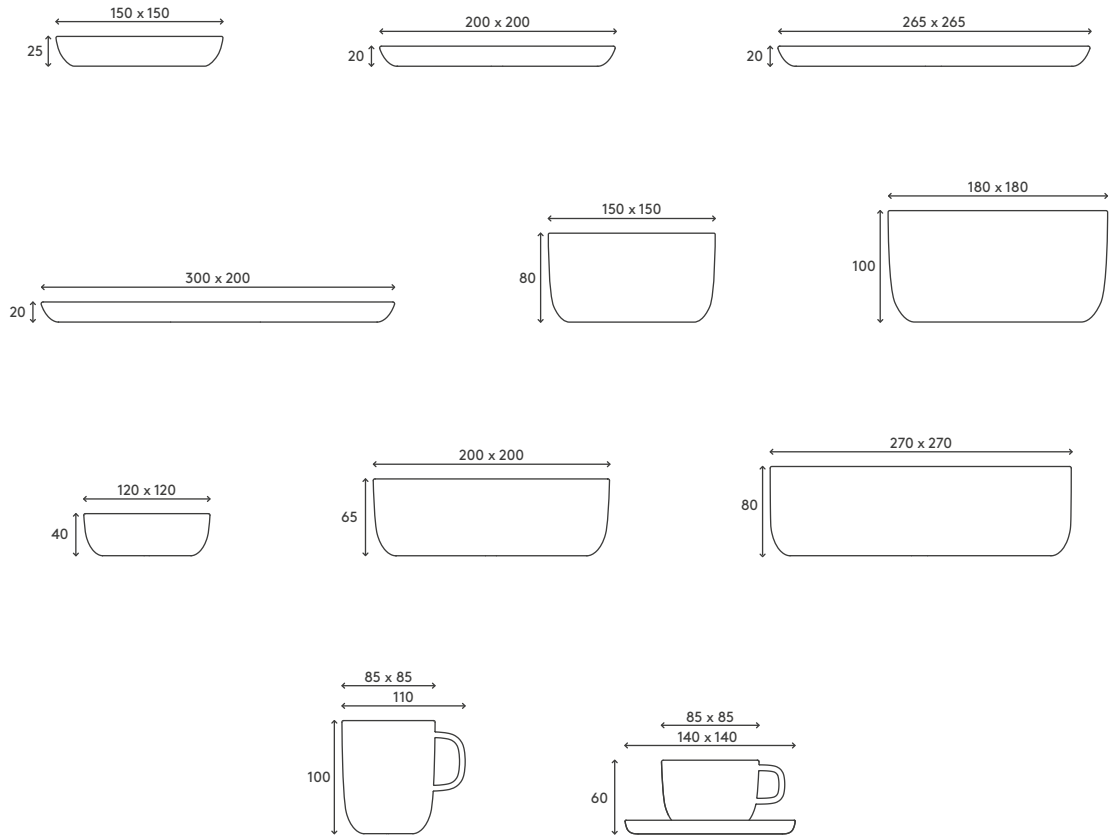

**VAHLO 64750**

# Side Plate | Beilagenteller  
 Dimensions H 2,5 cm, B 15 cm, T 15 cm  
 Materials ST2  
 Colour Mirage Gray

**64750**  
Mirage Gray



**64761**  
Moonbeam



**VAHLO 64751**

# Dessert Plate | Dessertteller  
 Dimensions H 2 cm, B 20 cm, T 20 cm  
 Materials ST2  
 Colour Mirage Gray

**64751**  
Mirage Gray



**64762**  
Moonbeam



# Pallet delivery only. Nur Palettenversand.

# DINING ESSENTIALS

## VAHLO 64752

# Dinner Plate | Speiseteller  
 Dimensions H 2 cm, B 26,5 cm, T 26,5 cm  
 Materials ST2  
 Colour Mirage Gray



## VAHLO 64753

# Serving Plate | Servierplatte  
 Dimensions H 2 cm, B 30 cm, T 20 cm  
 Materials ST2  
 Colour Mirage Gray



## VAHLO 64754

# Bowl | Schale  
 Dimensions H 8 cm, B 15 cm, T 15 cm  
 Materials ST2  
 Colour Mirage Gray  
 Features Size: M



## VAHLO 64755

# Bowl | Schale  
 Dimensions H 10 cm, B 18 cm, T 18 cm  
 Materials ST2  
 Colour Mirage Gray  
 Features Size: L



## VAHLO 64756

# Salad Bowl | Salatschale  
 Dimensions H 4 cm, B 12 cm, T 12 cm  
 Materials ST2  
 Colour Mirage Gray  
 Features Size: S



**VAHLO 64757**

# Salad Bowl | Salatschale  
 Dimensions H 6,5 cm, B 20 cm, T 20 cm  
 Materials ST2  
 Colour Mirage Gray  
 Features Size: M



**VAHLO 64758**

# Salad Bowl | Salatschale  
 Dimensions H 8 cm, B 27 cm, T 27 cm  
 Materials ST2  
 Colour Mirage Gray  
 Features Size: L



**VAHLO 64759**

# Mug with Handle | Becher mit Henkel  
 Dimensions H 10 cm, B 8,5 cm, T 8,5 cm  
 Materials ST2  
 Colour Mirage Gray



**VAHLO 64760**

# Set of 2 Coffee Cups | Set 2 Kaffeetassen  
 Dimensions H 6 cm, B 8,5 cm, T 8,5 cm  
 H 1,5 cm, B 14 cm, T 14 cm  
 Materials ST2  
 Colour Mirage Gray



# Pallet delivery only. Nur Palettenversand.





#### KUMI - UNIQUE WITH PERSONALITY

This tabletop range created by studio blomus has not only typical Japanese shapes that show the minimalist design language which fits so well with the blomus approach of designing everyday objects. It also has a fascinating – but very traditional Japanese – reactive glazing. This effect glazing comes out different with every firing, and reacts on the slightest variations of oxygen in the kiln atmosphere. These stoneware dishes are dishwasher safe and microwave safe. This semi-matt finished glaze may have dots and imperfections, may scratch, as it is a very soft surface – nevertheless it is no damage, it is just part of this sophisticated approach. This is why it is called KUMI, which takes its name from the Japanese word for eternal beauty.

#### KUMI - EINZIGARTIG UND MIT PERSÖNLICHKEIT

Diese Tabletop-Serie des studio blomus hat nicht nur typisch japanische Formen, welche die minimalistische Designsprache der Alltagsgegenstände im blomus-Sortiment widerspiegelt. Sie hat auch eine faszinierende – aber sehr traditionelle japanische – reaktive Glasur. Diese Effektglasur entwickelt sich bei jedem Brand anders und reagiert auf die geringsten Veränderungen des Sauerstoffs in der Ofenatmosphäre. Die Steingutartikel sind spülmaschinen- und mikrowelleneeignet. Diese halbmatte Glasur kann Einschlüsse und Unvollkommenheiten aufweisen, sie kann Kratzer bekommen, da es sich um eine sehr weiche Oberfläche handelt – dennoch ist dies kein Schaden, sondern nur ein Teil dieses raffinierten Herstellungsverfahrens. Daher der Name KUMI, der sich vom japanischen Wort für ewige Schönheit ableitet.



The QR code leads you to the KUMI page.  
Der QR-Code führt Sie zur KUMI Seite.

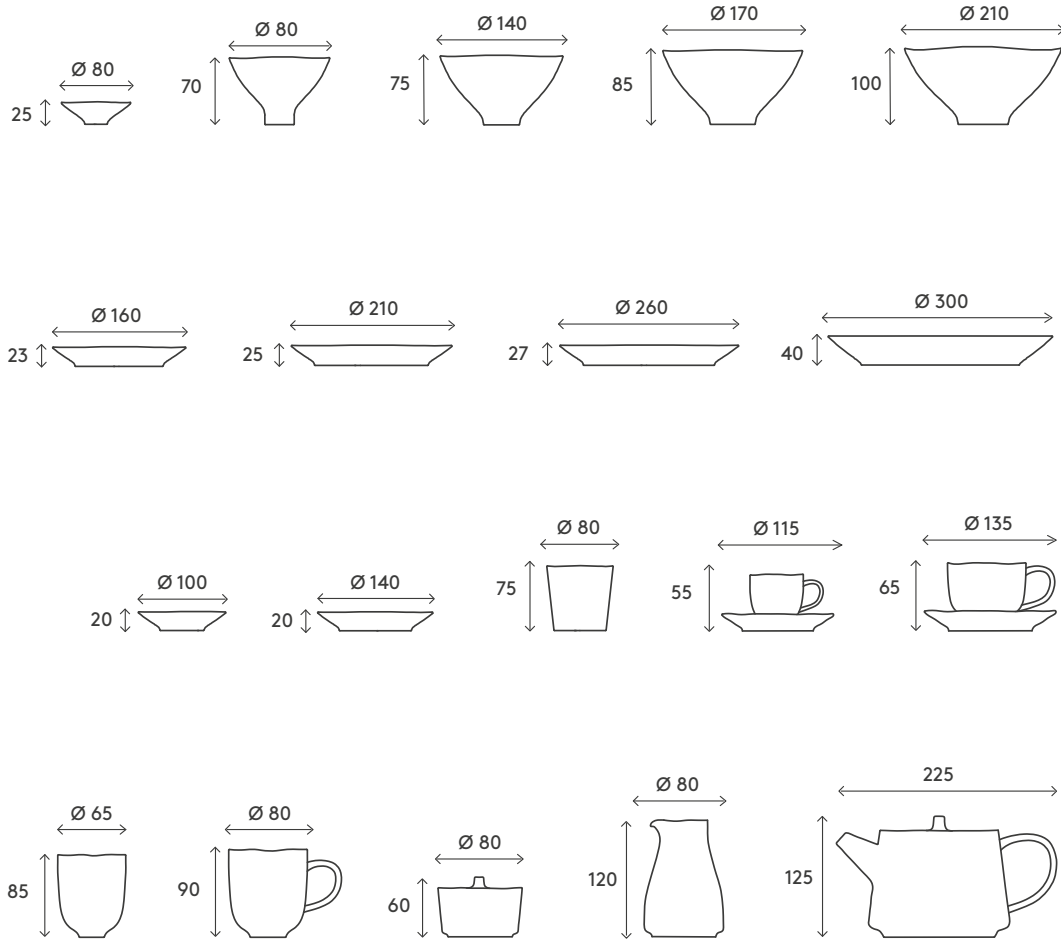

**KUMI 64411**

# Side Plate | Beilagenteller  
 Dimensions H 2,3 cm, Ø 16 cm  
 Materials ST2  
 Colour Espresso

64411  
Espresso



64429  
Fungi



**KUMI 64412**

# Dessert Plate | Dessertteller  
 Dimensions H 2,5 cm, Ø 21 cm  
 Materials ST2  
 Colour Espresso

64412  
Espresso



64430  
Fungi



# Pallet delivery only. Nur Palettenversand.

# DINING ESSENTIALS

## KUMI 64413

# Dinner Plate | Speiseteller  
 Dimensions H 2,7 cm, Ø 26 cm  
 Materials ST2  
 Colour Espresso



## KUMI 64414

# Bowl | Schale  
 Dimensions H 2,5 cm, Ø 8 cm  
 Materials ST2  
 Colour Espresso  
 Features Size: XS

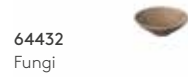
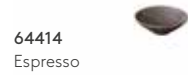

## KUMI 64415

# Bowl | Schale  
 Dimensions H 7 cm, Ø 12 cm  
 Materials ST2  
 Colour Espresso  
 Features Size: S



## KUMI 64416

# Bowl | Schale  
 Dimensions H 7,5 cm, Ø 14 cm  
 Materials ST2  
 Colour Espresso  
 Features Size: M



## KUMI 64417

# Bowl | Schale  
 Dimensions H 8,5 cm, Ø 17 cm  
 Materials ST2  
 Colour Espresso  
 Features Size: L



## KUMI 64418

# Plate | Teller  
 Dimensions H 2 cm, Ø 10 cm  
 Materials ST2  
 Colour Espresso  
 Features Size: XS





**KUMI 64419**

# Plate | Teller  
 Dimensions H 2 cm, Ø 14 cm  
 Materials ST2  
 Colour Espresso  
 Features Size: S



**KUMI 64420**

# Salad Bowl | Salatschale  
 Dimensions H 10 cm, Ø 21 cm  
 Materials ST2  
 Colour Espresso  
 Features Size: S



**KUMI 64421**

# Salad Bowl | Salatschale  
 Dimensions H 4 cm, Ø 30 cm  
 Materials ST2  
 Colour Espresso



**KUMI 64422**

# Mug without Handle | Tasse ohne Henkel  
 Dimensions H 7,5 cm, Ø 8 cm, V 180 ml  
 Materials ST2  
 Colour Espresso

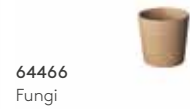

**KUMI 64577**

# Mug | Becher  
 Dimensions H 8,5 cm, Ø 6,5 cm, V 150 ml  
 Materials ST2  
 Colour Espresso



# Pallet delivery only. Nur Palettenversand.

# DINING ESSENTIALS

## KUMI 64423

# Mug with Handle | Tasse mit Henkel  
 Dimensions H 9 cm, B 11,5 cm, Ø 8 cm,  
 V 290 ml  
 Materials ST2  
 Colour Espresso

64423  
Espresso



64467  
Fungi



## KUMI 64424

# Set of 2 Espresso Cups |  
 Set 2 Espressotassen  
 Dimensions H 5 cm, B 8 cm, Ø 5,5 cm,  
 V 60 ml, H 2 cm, Ø 11,5 cm  
 Materials ST2  
 Colour Espresso

64424  
Espresso



64468  
Fungi



## KUMI 64425

# Set of 2 Coffee Cups | Set 2 Kaffeetassen  
 Dimensions H 6 cm, B 10,5 cm, Ø 8 cm,  
 V 190 ml, H 2 cm, Ø 13,5 cm  
 Materials ST2  
 Colour Espresso

64425  
Espresso



64469  
Fungi



## KUMI 64426

# Teapot | Teekanne  
 Dimensions H 12,5 cm, B 22,5 cm,  
 Ø 14,5 cm, V 1 l  
 Materials ST2  
 Colour Espresso

64426  
Espresso



64470  
Fungi



## KUMI 64427

# Creamer | Milchkännchen  
 Dimensions H 12 cm, Ø 8 cm, V 290 ml  
 Materials ST2  
 Colour Espresso

64427  
Espresso



64471  
Fungi



## KUMI 64428

# Sugar Bowl | Zuckerdose  
 Dimensions H 6 cm, Ø 8,5 cm  
 Materials ST2  
 Colour Espresso

64428  
Espresso



64472  
Fungi





# Pallet delivery only. Nur Palettenversand.



### STONEWARE

SABLO is made from coloured clay and a unique mix of quartz, minerals, oxides. Stoneware is defined as a group of ceramic products. Stoneware is used to produce plates, dishes, cachepots and bowls, moulded using special casting techniques. The high temperatures during the firing process make stoneware more stable than clay and less translucent than porcelain.

The colours, shapes, appearance of the glaze as well as the overall look depend on the firing temperature and time and may change. Each piece is surely unique and can show individual structures and shades. The clay of SABLO is fired at a very high temperature and therefore it doesn't need to be glazed everywhere.

### CARE

Stoneware tableware is dishwasher safe and can be used in a microwave oven.

### STEINGUT

SABLO besteht aus einer einzigartigen Mischung aus farbigem Ton, Quarz, Mineralien wie Calcit sowie Oxiden. Aus Steingut werden Teller, Geschirr, Übertöpfe und Schalen hergestellt, die im Gießverfahren ausgeformt werden. Die hohen Temperaturen während des Brennvorgangs machen Steingut stabiler als Ton und weniger durchscheinend als Porzellan.

Die Farben, Formen, das Aussehen der Glasur sowie das Gesamtbild hängen von der Brenntemperatur und der Brenndauer ab und variieren. Dadurch ist jedes Stück ein Unikat und kann individuelle Strukturen und Schattierungen aufweisen. Der Ton von SABLO wird bei einer sehr hohen Temperatur gebrannt und muss daher nicht überall glasiert werden.

### PFLEGE

Steingut ist spülmaschinengeeignet und kann in der Mikrowelle verwendet werden.

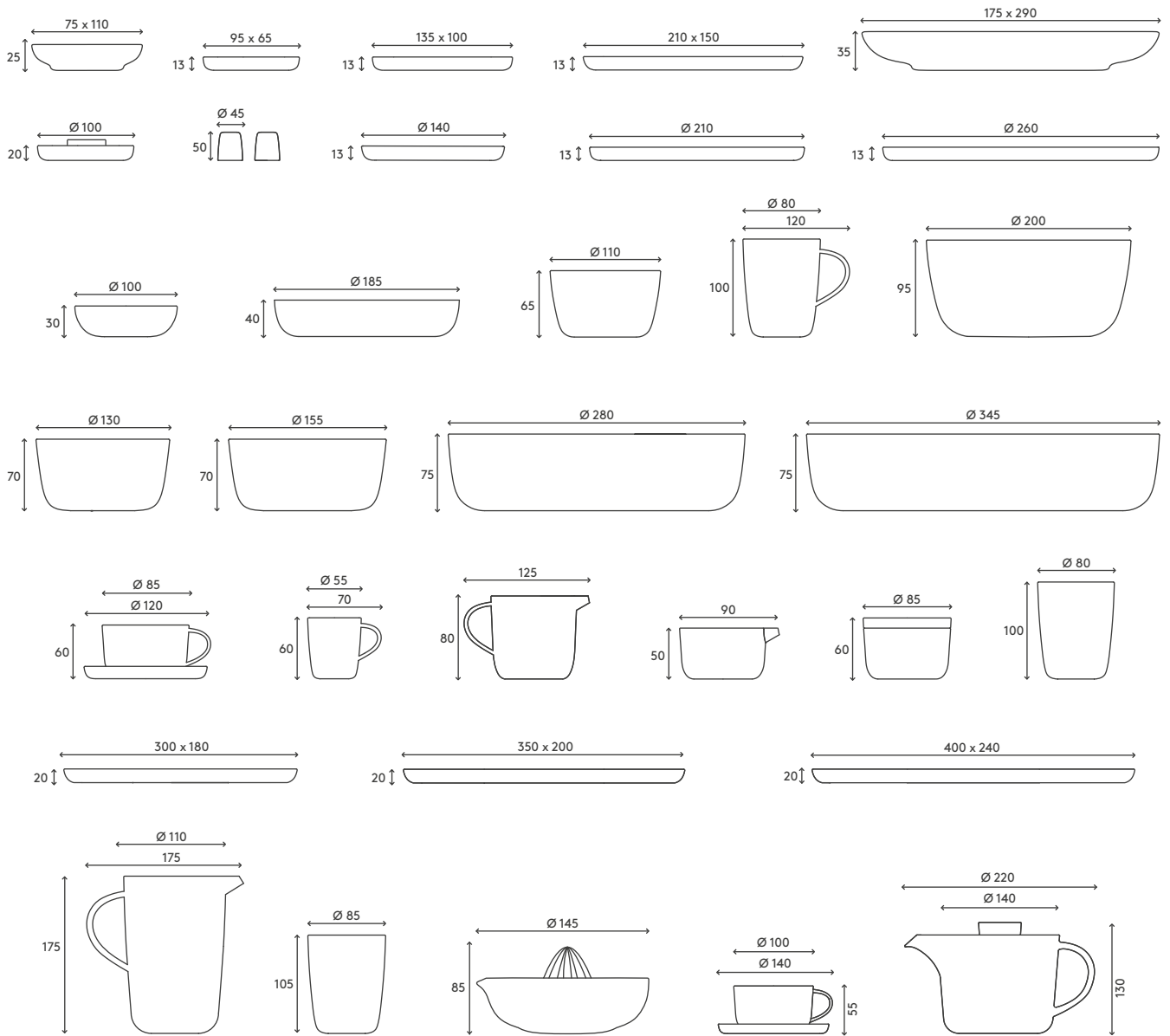

**SABLO 64100**

# Side Plate | Beilagenteller  
 Dimensions H 1,3 cm, Ø 14 cm  
 Materials ST2  
 Colour Cloud



**SABLO 64101**

# Dessert Plate | Dessertteller  
 Dimensions H 1,3 cm, Ø 21 cm  
 Materials ST2  
 Colour Cloud



**SABLO 64102**

# Dinner Plate | Speiseteller  
 Dimensions H 1,3 cm, Ø 26 cm  
 Materials ST2  
 Colour Cloud



# Pallet delivery only. Nur Palettenversand.

## DINING ESSENTIALS

### SABLO 64103

# Bowl | Schale  
Dimensions H 6,5 cm, Ø 11 cm  
Materials ST2  
Colour Cloud  
Features Size: S



### SABLO 64162

# Bowl | Schale  
Dimensions H 7 cm, Ø 13 cm  
Materials ST2  
Colour Cloud



### SABLO 64104

# Bowl | Schale  
Dimensions H 7 cm, Ø 15,5 cm  
Materials ST2  
Colour Cloud  
Features Size: M



### SABLO 64105

# Bowl | Schale  
Dimensions H 9,5 cm, Ø 20 cm  
Materials ST2  
Colour Cloud  
Features Size: L



### SABLO 64161

# Bowl | Salatschüssel  
Dimensions H 7,5 cm, Ø 28 cm  
Materials ST2  
Colour Cloud



### SABLO 64106

# Salad Bowl | Salatschüssel  
Dimensions H 7,5 cm, Ø 34,5 cm  
Materials ST2  
Colour Cloud



### SABLO 64107

# Snack Bowl | Snackschale  
Dimensions H 3 cm, Ø 10 cm  
Materials ST2  
Colour Cloud



### SABLO 64108

# Dessert Plate | Tiefer Teller  
Dimensions H 4 cm, Ø 18,5 cm  
Materials ST2  
Colour Cloud



### SABLO 64109

# Snack Plate | Snack Teller  
Dimensions H 1,3 cm, B 6,5 cm, T 9,5 cm  
Materials ST2  
Colour Cloud  
Features Size: S



**SABLO 64110**

# Snack Plate | Snack Teller  
 Dimensions H 1,3 cm, B 10 cm, T 13,5 cm  
 Materials ST2  
 Colour Cloud  
 Features Size: M



**SABLO 64111**

# Snack Plate | Snack Teller  
 Dimensions H 1,3 cm, B 15 cm, T 21 cm  
 Materials ST2  
 Colour Cloud  
 Features Size: L



**SABLO 64273**

# Egg Cups, Set of 2 | Eierbecher, Set 2 Stück  
 Dimensions H 2,2 cm, Ø 10 cm  
 Materials ST2  
 Colour Cloud



**SABLO 64114**

# Mug with Handle | Becher mit Henkel  
 Dimensions H 10 cm, T 12 cm, Ø 8 cm, 250 ml  
 Materials ST2  
 Colour Cloud



**SABLO 64112**

# Set of 2 Coffee Cups, 4 pcs. |  
 Set 2 Kaffeetassen, 4 tlg.  
 Dimensions H 5 cm, T 11 cm, Ø 8,5 cm,  
 V 150 ml, H 1,2 cm, Ø 12 cm  
 Materials ST2  
 Colour Cloud



**SABLO 64115**

# Espresso Cup | Espressotasse  
 Dimensions H 6 cm, T 7 cm, Ø 5,5 cm, V 70 ml  
 Materials ST2  
 Colour Cloud



**SABLO 64408**

# Creamer | Milchkännchen  
 Dimensions H 8 cm, T 12,5 cm, Ø 8,5 cm,  
 V 230 ml  
 Materials ST2  
 Colour Cloud



**SABLO 64159**

# Set of 2 Thermo Mugs | Set 2 Thermobecher  
 Dimensions H 10,5 cm, Ø 8,5 cm, V 260 ml  
 Materials ST2  
 Colour Cloud



**SABLO 64116**

# Creamer | Milchkännchen  
 Dimensions H 5 cm, T 9 cm, Ø 8,5 cm, V 150 ml  
 Materials ST2  
 Colour Cloud



# Pallet delivery only. Nur Palettenversand.



## DINING ESSENTIALS

### SABLO 64117

# Sugar Bowl | Zuckerdose  
Dimensions H 6 cm, Ø 8,5 cm  
Materials ST2  
Colour Cloud



### SABLO 64113

# Mug | Becher  
Dimensions H 10 cm, Ø 8 cm, 250 ml  
Materials ST2  
Colour Cloud



### SABLO 64160

# Jug | Krug  
Dimensions H 17,5 cm, B 17,5 cm, Ø 11 cm, V 1 l  
Materials ST2  
Colour Cloud



### SABLO 64118

# Teapot with Filter | Teekanne mit Filter  
Dimensions H 13 cm, B 22 cm, T 14 cm, V 1 l  
Materials ST2, SSp  
Colour Cloud  
Features With SS Filter  
Mit Edelstahlfilter



### SABLO 64158

# Set of 2 Tea Cups | Set 2 Teetassen  
Dimensions H 5,5 cm, B 12,5 cm Ø 10 cm, V 250 ml  
H 1,2 cm, Ø 14 cm  
Materials ST2  
Colour Cloud



### SABLO 64383

# Salt and Pepper Shaker | Salz- und Pfefferstreuer  
Dimensions H 5 cm, Ø 4,5 cm  
Materials ST2, K4  
Colour Cloud



### SABLO 64380

# Serving Plate | Servierplatte  
Dimensions H 2 cm, B 30 cm, T 18 cm  
Materials ST2  
Colour Cloud



### SABLO 64381

# Serving Plate | Servierplatte  
Dimensions H 2 cm, B 35 cm, T 20 cm  
Materials ST2  
Colour Cloud



### SABLO 64382

# Serving Plate | Servierplatte  
Dimensions H 2 cm, B 40 cm, T 24 cm  
Materials ST2  
Colour Cloud



**SABLO 64574**

# Lemon Press | Zitronenpresse  
 Dimensions H 8,5 cm, Ø 14,5 cm  
 Materials ST2  
 Colour Cloud



**SABLO 64575**

# Snack Plate | Snack Teller  
 Dimensions H 2,5 cm, B 11 cm, T 7,5 cm  
 Materials ST2  
 Colour Cloud



**SABLO 64576**

# Serving Plate | Servierplatte  
 Dimensions H 3,5 cm, B 29 cm, T 17,5 cm  
 Materials ST2  
 Colour Cloud



# Pallet delivery only. Nur Palettenversand.



### STONEWARE

Stoneware is manufactured from clay, quartz or minerals such as calcite and is defined as a group of ceramic products. Stoneware is used to produce plates, dishes, cachepots and bowls, moulded at very high temperatures using special casting techniques. The high temperatures during the firing process make stoneware more stable than clay and less translucent than porcelain. The colours depend on the firing temperature and time. Therefore, each piece can show individual structures and shades. As stoneware is not watertight in itself, it is often glazed.

### CARE

Stoneware tableware is dishwasher safe and can be used in a microwave oven.

### STEINGUT

Steingut besteht aus Ton, Quarz oder Mineralien wie Calcit und wird als Gruppe keramischer Erzeugnisse definiert. Aus Steingut werden Teller, Geschirr, Übertöpfe und Schalen hergestellt, die im Gießverfahren bei einer sehr hohen Temperatur ausgeformt werden. Durch die hohe Temperatur beim Brennprozess sind Steinwaren stabiler als Ton und weniger durchscheinend als Porzellan. Die Farben sind stark von der Brenntemperatur und -dauer abhängig. Daher kann jedes Stück individuelle Strukturen und Schattierungen vorweisen. Da Steingut von Natur aus nicht wasserdicht ist, wird es häufig glasiert, um diesen Zustand zu erreichen.

### PFLEGE

Steingut ist spülmaschinengeeignet und kann in der Mikrowelle verwendet werden.

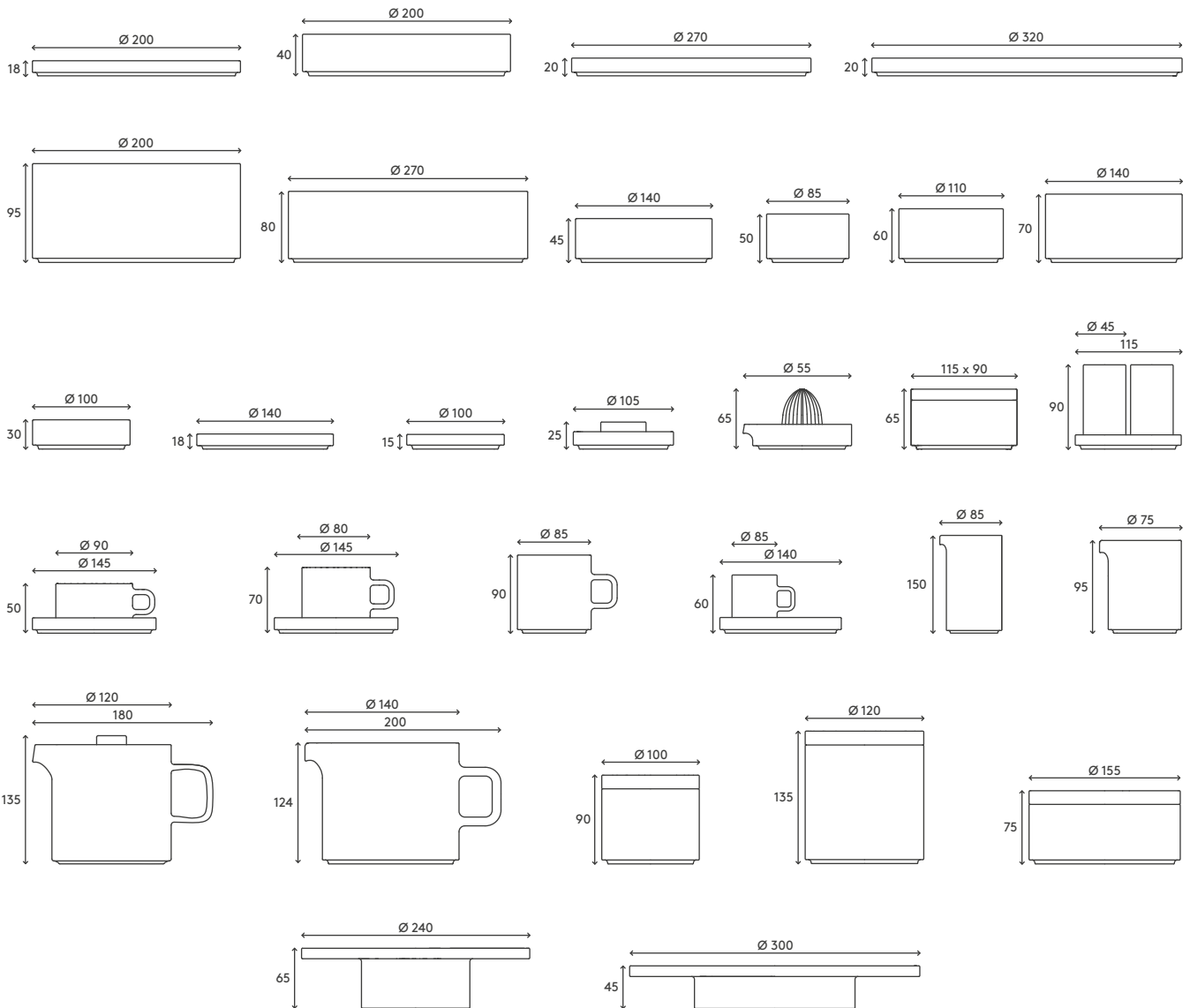

**PILAR 63988**

# Plate | Teller  
 Dimensions H 1,5 cm, Ø 10 cm  
 Materials ST2  
 Colour Moonbeam



**PILAR 63990**

# Plate | Teller  
 Dimensions H 1,5 cm, Ø 10 cm  
 Materials ST2  
 Colour Mirage Gray

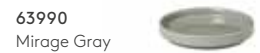

# Pallet delivery only. Nur Palettenversand.

# DINING ESSENTIALS

## PILAR 63984

# Bowl | Schale  
Dimensions H 3 cm, Ø 10 cm  
Materials ST2  
Colour Moonbeam

63984  
Moonbeam



63985  
Agave Green



## PILAR 63986

# Bowl | Schale  
Dimensions H 3 cm, Ø 10 cm  
Materials ST2  
Colour Mirage Gray

63986  
Mirage Gray



63987  
Pewter



## PILAR 64166

# Bowl | Schale  
Dimensions H 6 cm, Ø 11 cm  
Materials ST2  
Colour Moonbeam

64166  
Moonbeam



64167  
Agave Green



## PILAR 64168

# Bowl | Schale  
Dimensions H 6 cm, Ø 11 cm  
Materials ST2  
Colour Mirage Gray

64168  
Mirage Gray



64169  
Pewter



## PILAR 63980

# Plate | Teller  
Dimensions H 1,8 cm, Ø 14 cm  
Materials ST2  
Colour Moonbeam

63980  
Moonbeam



63981  
Agave Green



## PILAR 63982

# Plate | Teller  
Dimensions H 1,8 cm, Ø 14 cm  
Materials ST2  
Colour Mirage Gray

63982  
Mirage Gray



63983  
Pewter



**PILAR 63976**

# Bowl | Schale  
 Dimensions H 4,5 cm, Ø 14 cm  
 Materials ST2  
 Colour Moonbeam



**PILAR 63978**

# Bowl | Schale  
 Dimensions H 4,5 cm, Ø 14 cm  
 Materials ST2  
 Colour Mirage Gray



**PILAR 63693**

# Dessert Plate | Dessertteller  
 Dimensions H 1,8 cm, Ø 20 cm  
 Materials ST2  
 Colour Moonbeam



**PILAR 63715**

# Dessert Plate | Dessertteller  
 Dimensions H 1,8 cm, Ø 20 cm  
 Materials ST2  
 Colour Mirage Gray



**PILAR 63694**

# Deep Plate | Tiefer Teller  
 Dimensions H 4 cm, Ø 20 cm  
 Materials ST2  
 Colour Moonbeam



**PILAR 63716**

# Deep Plate | Tiefer Teller  
 Dimensions H 4 cm, Ø 20 cm  
 Materials ST2  
 Colour Mirage Gray



# Pallet delivery only. Nur Palettenversand.

# DINING ESSENTIALS

## PILAR 63695

# Dinner Plate | Speiseteller  
Dimensions H 2 cm, Ø 27 cm  
Materials ST2  
Colour Moonbeam



63695  
Moonbeam



63706  
Agave Green



## PILAR 63717

# Dinner Plate | Speiseteller  
Dimensions H 2 cm, Ø 27 cm  
Materials ST2  
Colour Mirage Gray



63717  
Mirage Gray



63964  
Pewter



## PILAR 63696

# Serving Plate | Servierteller  
Dimensions H 2 cm, Ø 32 cm  
Materials ST2  
Colour Moonbeam



63696  
Moonbeam



63707  
Agave Green



## PILAR 63718

# Serving Plate | Servierteller  
Dimensions H 2 cm, Ø 32 cm  
Materials ST2  
Colour Mirage Gray



63718  
Mirage Gray



63965  
Pewter



## PILAR 63697

# Bowl | Schale  
Dimensions H 9,5 cm, Ø 20 cm  
Materials ST2  
Colour Moonbeam



63697  
Moonbeam



63708  
Agave Green



## PILAR 63719

# Bowl | Schale  
Dimensions H 9,5 cm, Ø 20 cm  
Materials ST2  
Colour Mirage Gray



63719  
Mirage Gray



63966  
Pewter





**PILAR 63698**

# Bowl | Schale  
 Dimensions H 8 cm, Ø 27 cm  
 Materials ST2  
 Colour Moonbeam



63698  
Moonbeam



63709  
Agave Green



**PILAR 63720**

# Bowl | Schale  
 Dimensions H 8 cm, Ø 27 cm  
 Materials ST2  
 Colour Mirage Gray



63720  
Mirage Gray



63967  
Pewter



**PILAR 63699**

# Snack Bowl | Snackschale  
 Dimensions H 5 cm, Ø 8,5 cm  
 Materials ST2  
 Colour Moonbeam



63699  
Moonbeam



63710  
Agave Green



**PILAR 63721**

# Snack Bowl | Snackschale  
 Dimensions H 5 cm, Ø 8,5 cm  
 Materials ST2  
 Colour Mirage Gray



63721  
Mirage Gray



63968  
Pewter



**PILAR 63700**

# Bowl | Schale  
 Dimensions H 7 cm, Ø 14 cm  
 Materials ST2  
 Colour Moonbeam



63700  
Moonbeam



63711  
Agave Green



**PILAR 63722**

# Bowl | Schale  
 Dimensions H 7 cm, Ø 14 cm  
 Materials ST2  
 Colour Mirage Gray



63722  
Mirage Gray



63969  
Pewter



# Pallet delivery only. Nur Palettenversand.

# DINING ESSENTIALS

## PILAR 63701

# Jug | Krug  
 Dimensions H 15 cm, T 9,5 cm,  
 Ø 8,5 cm, V 0,5 l  
 Materials ST2  
 Colour Moonbeam



63701  
Moonbeam



63712  
Agave Green



## PILAR 63723

# Jug | Krug  
 Dimensions H 15 cm, T 9,5 cm,  
 Ø 8,5 cm, V 0,5 l  
 Materials ST2  
 Colour Mirage Gray



63723  
Mirage Gray



63970  
Pewter



## PILAR 63992

# Creamer | Milchkännchen  
 Dimensions H 9,5 cm, T 8,5 cm,  
 Ø 7,5 cm, V 280 ml  
 Materials ST2  
 Colour Moonbeam



63992  
Moonbeam



63993  
Agave Green



## PILAR 63994

# Creamer | Milchkännchen  
 Dimensions H 9,5 cm, T 8,5 cm,  
 Ø 7,5 cm, V 280 ml  
 Materials ST2  
 Colour Mirage Gray



63994  
Mirage Gray



63995  
Pewter



## PILAR 64269

# Egg Cups, Set of 2 | Set 2 Eierbecher  
 Dimensions H 2,5 cm, Ø 10,5 cm  
 Materials ST2  
 Colour Moonbeam



64269  
Moonbeam



64270  
Agave Green



## PILAR 64271

# Egg Cups, Set of 2 | Set 2 Eierbecher  
 Dimensions H 2,5 cm, Ø 10,5 cm  
 Materials ST2  
 Colour Mirage Gray



64271  
Mirage Gray



64272  
Pewter



**PILAR 64367**

# Butter Dish | Butterdose  
 Dimensions H 6,5 cm, B 12 cm, T 9 cm  
 Materials ST2  
 Colour Moonbeam



**PILAR 64369**

# Butter Dish | Butterdose  
 Dimensions H 6,5 cm, B 12 cm, T 9 cm  
 Materials ST2  
 Colour Mirage Gray



**PILAR 63804**

# Jug | Kanne  
 Dimensions H 12,5 cm, T 20 cm, Ø 14 cm,  
 V 1 l  
 Materials ST2  
 Colour Moonbeam



**PILAR 63806**

# Jug | Kanne  
 Dimensions H 12,5 cm, T 20 cm, Ø 14 cm,  
 V 1 l  
 Materials ST2  
 Colour Mirage Gray



**PILAR 63702**

# Mug | Tasse  
 Dimensions H 9 cm, T 11,5 cm, Ø 8,5 cm,  
 V 250 ml  
 Materials ST2  
 Colour Moonbeam



**PILAR 63724**

# Mug | Tasse  
 Dimensions H 9 cm, T 11,5 cm, Ø 8,5 cm,  
 V 250 ml  
 Materials ST2  
 Colour Mirage Gray



# Pallet delivery only. Nur Palettenversand.

## DINING ESSENTIALS

### PILAR 63703

# Set of 2 Espresso Mugs 4 pcs. |  
Set 2 Espressotassen, 4 tlg.  
Dimensions H 6 cm, T 7,5 cm, Ø 5 cm,  
V 80 ml  
Materials ST2  
Colour Moonbeam

63703  
Moonbeam



63714  
Agave Green



### PILAR 63725

# Set of 2 Espresso Mugs 4 pcs. |  
Set 2 Espressotassen, 4 tlg.  
Dimensions H 6 cm, T 7,5 cm, Ø 5 cm,  
V 80 ml  
Materials ST2  
Colour Mirage Gray

63725  
Mirage Gray



63972  
Pewter



### PILAR 63907

# Set of 2 Coffee Cups, 4 pcs. |  
Set 2 Kaffeetassen, 4 tlg.  
Dimensions H 7 cm, T 11 cm, Ø 8 cm,  
V 200 ml, H 2 cm, Ø 14,5 cm  
Materials ST2  
Colour Moonbeam

63907  
Moonbeam



63909  
Agave Green



### PILAR 63911

# Set of 2 Coffee Cups, 4 pcs. |  
Set 2 Kaffeetassen, 4 tlg.  
Dimensions H 7 cm, T 11 cm, Ø 8 cm,  
V 200 ml, H 2 cm, Ø 14,5 cm  
Materials ST2  
Colour Mirage Gray

63911  
Mirage Gray



63974  
Pewter



### PILAR 63908

# Set of 2 Tea Cups, 4 pcs. |  
Set 2 Teetassen, 4 tlg.  
Dimensions H 5 cm, T 12 cm, Ø 9 cm,  
V 170 ml, H 2 cm, Ø 14,5 cm  
Materials ST2  
Colour Moonbeam

63908  
Moonbeam



63910  
Agave Green



### PILAR 63912

# Set of 2 Tea Cups, 4 pcs. |  
Set 2 Teetassen, 4 tlg.  
Dimensions H 5 cm, T 12 cm, Ø 9 cm,  
V 170 ml, H 2 cm, Ø 14,5 cm  
Materials ST2  
Colour Mirage Gray

63912  
Mirage Gray



63975  
Pewter



**PILAR 63996**

# Teapot | Teekanne  
 Dimensions H 13,5 cm, T 18 cm,  
 Ø 12 cm, V 1 l  
 Materials ST2  
 Colour Moonbeam



63996  
Moonbeam



63997  
Agave Green



**PILAR 63998**

# Teapot | Teekanne  
 Dimensions H 13,5 cm, T 18 cm,  
 Ø 12 cm, V 1 l  
 Materials ST2  
 Colour Mirage Gray



63998  
Mirage Gray



63999  
Pewter



**PILAR 64772**

# Cakestand | Tortenplatte  
 Dimensions H 6,5 cm, Ø 24 cm  
 Materials ST2  
 Colour Moonbeam  
 Features Size: S



64772  
Moonbeam



64775  
Agave Green



**PILAR 64773**

# Cakestand | Tortenplatte  
 Dimensions H 6,5 cm, Ø 24 cm  
 Materials ST2  
 Colour Mirage Gray  
 Features Size: S



64773  
Mirage Gray



64774  
Pewter



**PILAR 64776**

# Cakestand | Tortenplatte  
 Dimensions H 4,5 cm, Ø 30 cm  
 Materials ST2  
 Colour Moonbeam  
 Features Size: L



64776  
Moonbeam



64779  
Agave Green



**PILAR 64777**

# Cakestand | Tortenplatte  
 Dimensions H 4,5 cm, Ø 30 cm  
 Materials ST2  
 Colour Mirage Gray  
 Features Size: L



64777  
Mirage Gray



64778  
Pewter



# Pallet delivery only. Nur Palettenversand.

**PILAR 64780**

# Salt & Pepper shaker |  
Salz- & Pfefferstreuer  
Dimensions H 9 cm, B 11,5 cm, Ø 4,5 cm  
Materials ST2  
Colour Moonbeam



64780  
Moonbeam

64783  
Agave Green

**PILAR 64781**

# Salt & Pepper shaker |  
Salz- & Pfefferstreuer  
Dimensions H 9 cm, B 11,5 cm, Ø 4,5 cm  
Materials ST2  
Colour Mirage Gray



64781  
Mirage Gray

64782  
Pewter

**PILAR 64796**

# Lemon Press | Zitronenpresse  
Dimensions H 6,5 cm, Ø 5,5 cm  
Materials ST2  
Colour Moonbeam



64796  
Moonbeam

64799  
Agave Green

**PILAR 64797**

# Lemon Press | Zitronenpresse  
Dimensions H 6,5 cm, Ø 5,5 cm  
Materials ST2  
Colour Mirage Gray



64797  
Mirage Gray

64798  
Pewter

**PILAR 64784**

# Storage Box | Vorratsdose  
Dimensions H 9 cm, Ø 10 cm  
Materials ST2, K4  
Colour Moonbeam  
Features Size: S



64784  
Moonbeam

64787  
Agave Green

**PILAR 64785**

# Storage Box | Vorratsdose  
Dimensions H 9 cm, Ø 10 cm  
Materials ST2, K4  
Colour Mirage Gray  
Features Size: S



64785  
Mirage Gray

64786  
Pewter

**PILAR 64788**

# Storage Box | Vorratsdose  
 Dimensions H 13,5 cm, Ø 12 cm  
 Materials ST2, K4  
 Colour Moonbeam  
 Features Size: M



**PILAR 64789**

# Storage Box | Vorratsdose  
 Dimensions H 13,5 cm, Ø 12 cm  
 Materials ST2, K4  
 Colour Mirage Gray  
 Features Size: M



**PILAR 64792**

# Storage Box | Vorratsdose  
 Dimensions H 7,5 cm, Ø 15,5 cm  
 Materials ST2, K4  
 Colour Moonbeam



**PILAR 64793**

# Storage Box | Vorratsdose  
 Dimensions H 7,5 cm, Ø 15,5 cm  
 Materials ST2, K4  
 Colour Mirage Gray



# Pallet delivery only. Nur Palettenversand.



**STELLA 64195**

Cutlery Set 16 Pieces | Besteck Set 16-teilig  
 Materials SSv  
 Colour Black

64195  
Black



64455  
Champagne



**STELLA 64196**

Spoon | Löffel  
 Dimensions H 2 cm, B 4 cm, T 20 cm  
 Materials SSv  
 Colour Black

64196  
Black



64456  
Champagne



**STELLA 64473**

Salad Servers | Salatbesteck  
 Dimensions L 28 cm, B 6 cm  
 Materials SSv  
 Colour Black



**STELLA 64197**

Teaspoon | Teelöffel  
 Dimensions H 1,5 cm, B 3 cm, T 15 cm  
 Materials SSv  
 Colour Black

64197  
Black



64458  
Champagne



**STELLA 64198**

Fork | Gabel  
 Dimensions H 1,5 cm, B 2,5 cm, T 20 cm  
 Materials SSv  
 Colour Black

64198  
Black



64457  
Champagne



**STELLA 64199**

Knife | Messer  
 Dimensions H 2 cm, B 0,8 cm, T 22 cm  
 Materials SSv  
 Colour Black

64199  
Black



64459  
Champagne



**STELLA 64474**

Set of 4 Cake Forks | Set 4 Kuchengabeln  
 Dimensions L 15,5 cm, B 2 cm  
 Materials SSv  
 Colour Black



64474  
Black



64477  
Champagne

**STELLA 64475**

Set of 4 Espresso Spoons |  
 Set 4 Espressolöffel  
 Dimensions L 11 cm, B 2,5 cm  
 Materials SSv  
 Colour Black



64475  
Black



64478  
Champagne



**STELLA CUTLERY**

While the cutlery is suitable to be used in a dishwasher, it is not dishwasher safe. We advise against extensive use in a dishwasher and recommend hand washing.

Please make sure not to use any aggressive or abrasive cleaning agents. Never use steel wool, abrasive sponges or hard brushes to remove tenacious stains. This can permanently damage the surface.

**STELLA BESTECK**

Das Besteck ist spülmaschinengeeignet, aber nicht spülmaschinenfest. Vor einer langfristigen Benutzung in der Spülmaschine raten wir ab und empfehlen Handwäsche.

Bitte keine scharfen oder aggressiven Reinigungsmittel verwenden. Benutzen Sie auf keinen Fall Stahlwolle, Scheuerschwämme oder harte Bürsten, um hartnäckige Verschmutzungen zu entfernen. Die Oberfläche kann hierdurch dauerhaft beschädigt werden.

## DINING ESSENTIALS

### STELLA 63824

Cutlery Set 16 Pieces | Besteck-Set 16-teilig  
Materials SSm



### STELLA 63827

Fork | Gabel  
Dimensions H 1,5 cm, B 2,5 cm, T 20 cm  
Materials SSm



### STELLA 63828

Knife | Messer  
Dimensions H 2 cm, B 0,8 cm, T 22 cm  
Materials SSm



### STELLA 63825

Spoon | Löffel  
Dimensions H 2 cm, B 4 cm, T 20 cm  
Materials SSm



### STELLA 63948

Sauce Spoon | Soßenlöffel  
Dimensions L 20,5 cm, H 5 cm, B 7 cm  
Materials SSm



### STELLA 63949

Serving Spoon | Servierlöffel  
Dimensions L 25 cm, B 5,5 cm  
Materials SSm



### STELLA 63826

Tea Spoon | Teelöffel  
Dimensions H 1,5 cm, B 3 cm, T 15 cm  
Materials SSm



### STELLA 63951

Set of 2 Serving Forks | Set 2 Serviergabeln  
Dimensions L 20 cm, B 2,5 cm  
Materials SSm



### STELLA 63952

Salad Servers | Salatbesteck  
Dimensions L 28 cm, B 6 cm  
Materials SSm



**STELLA 63950**

Set of 4 Cake Forks | Set 4 Kuchengabeln  
 Dimensions L 15,5 cm, B 2 cm  
 Materials SSm



**STELLA 63953**

Set of 4 Espresso Spoons | Set 4 Espressolöffel  
 Dimensions L 11 cm, B 2,5 cm  
 Materials SSm



**STELLA 63954**

Set of 4 Butter Knives | Set 4 Buttermesser  
 Dimensions L 18,5 cm, B 2 cm  
 Materials SSm



**EASY 66793**

Salad Servers | Salatbesteck  
 Dimensions H 28 cm, B 6,5 cm  
 Materials SSm



**STELLA - DESIGN BY THERESA RAND**

The cutlery is dishwasher safe. Please take care not to use any caustic or aggressive cleaning agents. Never use steel wool, abrasive sponges or hard brushes to remove tenacious stains. The finish of the surface may suffer permanent damage. When washing by hand, please clean the product in the direction of the brushed surface to avoid the risk of scratches on the surface.

After cleaning, we recommend to dry the cutlery with a soft cloth in the direction of the finish. To maintain the special matt brushed appearance of the surface, we advise not to polish the cutlery. Stainless steel is an easy to care material, but still needs maintenance on a regular basis. In particular, we strongly recommend you rinse and clean off residues of acidic foods immediately after use. The acids may cause rust on the surface if not cleaned.

**STELLA - DESIGN VON THERESA RAND**

Das Besteck ist zur Reinigung in der Spülmaschine geeignet. Achten Sie bitte darauf, keine scharfen oder aggressiven Reinigungsmittel zu verwenden. Benutzen Sie auf keinen Fall Stahlwolle, Scheuerschwämme oder harte Bürsten, um hartnäckige Verschmutzungen zu entfernen. Die Oberfläche kann hierdurch dauerhaft beschädigt werden. Bei dem Spülvorgang per Hand, reinigen Sie bitte immer in Bürst-/Schliffrichtung. Ansonsten können Kratzer entstehen.

Nach der Reinigung empfehlen wir, das Besteck mit einem weichen Tuch in Bürst-/Schliffrichtung leicht trocken zu reiben. Um die besondere matte Optik der Oberfläche zu wahren, raten wir jedoch vom Polieren ab. Grundsätzlich ist Edelstahl als Material zwar pflegeleicht, jedoch nicht pflegefrei. Daher empfehlen wir insbesondere Rückstände säurehaltiger Lebensmittel sofort nach dem Gebrauch abzuspülen. Es besteht hier die Gefahr, dass Rost in Folge der Säurewirkung auf dem Edelstahl entsteht.





**KOYOI STEEL 64704**

Set of 2 Stainless Steel Champagne Coupes |  
Set 2 Edelstahl Champagnerschalen  
Dimensions H 7,5 cm, Ø 10 cm, V 90 ml  
Materials SSm



**KOYOI 64489**

Prosecco Glass | Proseccoglas  
Dimensions H 13 cm, Ø 6,5 cm, V 200 ml  
Materials Gk



**KOYOI 64490**

Liquor Glass | Likörglas  
Dimensions H 10,5 cm, Ø 6 cm, V 130 ml  
Materials Gk



**KOYOI 64491**

Brandy Glass | Brandyglas  
Dimensions H 6,5 cm, Ø 7,5 cm, V 100 ml  
Materials Gk



**KOYOI 64492**

Champagne Coupe | Champagnerschale  
Dimensions H 7,5 cm, Ø 10 cm, V 90 ml  
Materials Gk



**KOYOI 64493**

Martini Glass | Martiniglas  
Dimensions H 8 cm, Ø 10 cm, V 110 ml  
Materials Gk



**KOYOI STEEL – DESIGN BY KAZUSHIGE MIYAKE**

KOYOI means “this evening” in Japanese, and has a romantic, poetic feel to it. How suitable for these little specialties!

These five carefully handcrafted and mouth-blown treasures with thick glass bottom have been selected for a range of your favorite drinks - two wide-open shapes for Martinis and Champagnes, one tall Prosecco glass, and two smaller ones for your Brandy and Liquor tastings.

The glasses are dishwasher-safe.

**KOYOI STEEL – DESIGN VON KAZUSHIGE MIYAKE**

KOYOI bedeutet auf Japanisch „dieser Abend“ und hat eine romantische, poetische Ausstrahlung. Wie passend für diese besondere Glaskollektion!

Diese fünf sorgfältig handgefertigten und mundgeblasenen Schätze mit dickem Glasboden wurden für eine Reihe Ihrer Lieblingsgetränke ausgewählt - zwei weit offene Formen für Martini und Champagner, ein hohes Prosecco-Glas und zwei kleinere für Ihre Brandy- und Likör Verköstigungen.

Die KOYOI Gläser sind spülmaschinengeeignet.





### FUUMI

Discover our elegant, mouth-blown glass design from the FUUMI series, created by experienced craftsmen. Each piece is unique, characterized by the subtle differences that arise during the manufacturing process. The glass body is dyed throughout, while the delicate stem and base made of clear glass lend it a refined elegance. The collection is complemented by a water carafe with a matching cork lid.

Care: The glasses are dishwasher safe. The cork lid of the carafe is not dishwasher safe.

### FUUMI

Entdecken Sie unser elegantes, mundgeblasenes Glasdesign der FUUMI Serie, das durch erfahrene Handarbeit entsteht. Jedes Stück ist ein Unikat, geprägt von den feinen Unterschieden, die während des Herstellungsprozesses entstehen. Der Glaskörper ist durchgefärbt, während der zarte Stiel und der Fuß aus Klarglas eine raffinierte Eleganz verleihen. Ergänzt wird die Kollektion durch eine Wasserkaraffe mit passendem Korkdeckel.

Pflege: Die Gläser sind spülmaschinengeeignet. Der Karaffenverschluss aus Kork ist nicht spülmaschinengeeignet.



**FUUMI 64535**

Set of 4 Champagne Glasses |  
 Set 4 Sektgläser  
 Dimensions H 23,5 cm, Ø 7 cm, V 220 ml  
 Materials Gk, Gf  
 Colour Smoke/Clear glass  
 Features Mouthblown  
 Mundgeblasen



**FUUMI 64537**

Set of 4 Champagne Saucer |  
 Set 4 Sektschalen  
 Dimensions H 14 cm, Ø 10,5 cm, V 280 ml  
 Materials Gk, Gf  
 Colour Smoke/Clear glass  
 Features Mouthblown  
 Mundgeblasen

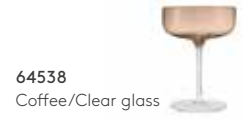

**FUUMI 64539**

Set of 4 Tumbler | Set 4 Trinkgläser  
 Dimensions H 9 cm, Ø 8 cm, V 340ml  
 Materials Gk, Gf  
 Colour Smoke  
 Features Mouthblown  
 Mundgeblasen



**FUUMI 64541**

Set of 4 White Wine Glasses |  
 Set 4 Weißweingläser  
 Dimensions H 21 cm, Ø 7,5 cm, V 310 ml  
 Materials Gk, Gf  
 Colour Smoke/Clear glass  
 Features Mouthblown  
 Mundgeblasen



**FUUMI 64543**

Set of 4 Red Wine Glasses |  
 Set 4 Rotweingläser  
 Dimensions H 22 cm, Ø 8 cm, V 400 ml  
 Materials Gk, Gf  
 Colour Smoke/Clear glass  
 Features Mouthblown  
 Mundgeblasen



**FUUMI 64545**

Water Carafe | Wasserkaraffe  
 Dimensions H 29 cm, Ø 9 cm, 1 l  
 Materials Gf, H4  
 Colour Smoke  
 Features Mouthblown  
 Mundgeblasen



## DINING ESSENTIALS

### BELO 64395

Set of 2 Champagne Glasses | Set 2 Sektkgläser  
Dimensions H 24,5 cm, Ø 6 cm, V 200 ml  
Materials Gk



### BELO 64398

Set of 2 White Wine Glasses | Set 2 Weißweingläser  
Dimensions H 22 cm, Ø 10 cm, V 400 ml  
Materials Gk



### BELO 64397

Set of 2 Red Wine Glasses | Set 2 Rotweingläser  
Dimensions H 24,5 cm, Ø 11 cm, V 600 ml  
Materials Gk



### BELO 64396

Set of 2 Champagne Saucers | Set 2 Sektschalen  
Dimensions H 14 cm, Ø 11 cm, V 200 ml  
Materials Gk



### BELO 64399

Set of 4 Tumblers | Set 4 Trinkgläser  
Dimensions H 9 cm, Ø 6,5 cm, V 280 ml  
Materials Gk



### BELO 64400

# Water Carafe | Wasserkaraffe  
Dimensions H 26 cm, Ø 11,5 cm, V 1,2 l  
Materials Gk



### BELO GLASSWARE

The BELO glassware series by Frederike Martens is made of high-quality, mouth-blown glass - which can be seen in small irregularities such as flow lines, small blisters and minimally different material thicknesses, which lets the colour elegantly vary from piece to piece. The big volume glass bodies are colour-ed through, the stem stays clear. The rim is cut and polished, providing a perfect finish for the gentle silhouettes. The line is complemented by a water carafe with glass lid. The BELO glasses and carafes are dishwasher safe.

### BELO GLASSERIE

Die BELO-Glasserie von Frederike Martens wird aus hochwertigem, mundgeblasenem Glas hergestellt - was man an kleinen Unregelmäßigkeiten wie Fließlinien, kleinen Blasen und minimal unterschiedlichen Materialstärken erkennen kann, was wiederum die Farbe von Glas zu Glas elegant variieren lässt. Die großvolumigen Glaskörper sind durchgefärbt, der Stiel bleibt klar. Der Rand ist geschliffen und poliert, was einen perfekten Abschluss für die sanften Silhouetten bietet.

Ergänzt wird die Linie durch eine Wasserkaraffe mit Glasdeckel. Die BELO Gläser und Karaffen sind spülmaschinengeeignet.



**BELO 64277**

Set of 2 Champagne Glasses |  
 Set 2 Sektgläser  
 Dimensions H 24,5 cm, Ø 6 cm, V 200 ml  
 Materials Gk, Gf  
 Colour Smoke

64277  
Smoke



64292  
Coffee



**BELO 64280**

Set of 2 White Wine Glasses |  
 Set 2 Weißweingläser  
 Dimensions H 22 cm, Ø 10 cm, V 400 ml  
 Materials Gk, Gf  
 Colour Smoke

64280  
Smoke



64295  
Coffee



**BELO 64279**

Set of 2 Red Wine Glasses |  
 Set 2 Rotweingläser  
 Dimensions H 24,5 cm, Ø 11 cm, V 600 ml  
 Materials Gk, Gf  
 Colour Smoke

64279  
Smoke



64294  
Coffee



**BELO 64278**

Set of 2 Champagne Saucers |  
 Set 2 Sektschalen  
 Dimensions H 14 cm, Ø 11 cm, V 200 ml  
 Materials Gk, Gf  
 Colour Smoke

64278  
Smoke



64293  
Coffee



**BELO 64249**

Set of 4 Tumblers | Set 4 Trinkgläser  
 Dimensions H 9 cm, Ø 6,5 cm, V 280 ml  
 Materials Gf  
 Colour Smoke

64249  
Smoke



64296  
Coffee



**BELO 64358**

Water Carafe | Wasserkaraffe  
 Dimensions H 26 cm, Ø 11,5 cm, V 1,2 l  
 Materials Gf  
 Colour Smoke

64358  
Smoke



64359  
Coffee



## DINING ESSENTIALS

### MERA 63915

Set of 2 Tumblers | Set 2 Trinkgläser  
Dimensions H 7 cm, Ø 7,5 cm, V 200 ml  
Materials Gf  
Colour Smoke



### MERA 63914

Set of 2 Tumblers | Set 2 Trinkgläser  
Dimensions H 9 cm, Ø 7 cm, V 20 ml  
Materials Gf  
Colour Smoke



### SPLASH 63807

Water Carafe | Wasserkaraffe  
Dimensions H 29,5 cm, Ø 9 cm, V 1 l  
Materials SSp, Gf, K4  
Colour Smoke



### SPLASH 63785

Water Carafe | Wasserkaraffe  
Dimensions H 29,5 cm, Ø 9 cm, V 1 l  
Materials SSp, Gk, K4  
Colour Magnet



63785  
Magnet

63787  
Sharkskin

63780  
Moonbeam



**NERO 63652**

Set of 2 Insulated Espresso Glasses |  
 Set 2 Thermo-Espressogläser  
 Dimensions H 6,5 cm, Ø 6 cm, V 80 ml  
 Materials Gk  
 Features Double-walled | Doppelwandig



**NERO 63653**

Set of 2 Insulated Coffee Glasses |  
 Set 2 Thermo-Kaffeegläser  
 Dimensions H 8,5 cm, Ø 7,5 cm, V 200 ml  
 Materials Gk  
 Features Double-walled | Doppelwandig



**NERO 63654**

Set of 2 Insulated Cappuccino Glasses |  
 Set 2 Thermo-Cappuccinogläser  
 Dimensions H 11,5 cm, Ø 7,5 cm, V 250 ml  
 Materials Gk  
 Features Double-walled | Doppelwandig



**ACQUA 63436**

Water Carafe | Wasserkaraffe  
 Dimensions H 30,5 cm, Ø 9 cm, V 1 l  
 Materials SSm, Gk, K4



**ACQUA 63448**

Water Carafe | Wasserkaraffe  
 Dimensions H 34,5 cm, Ø 10 cm, V 1,5 l  
 Materials SSm, Gk, K4



**NERO 63655**

Set of 2 Insulated Latte Macchiato Glasses |  
 Set 2 Thermo-Latte Macchiatogläser  
 Dimensions H 14 cm, Ø 7,5 cm, V 320 ml  
 Materials Gk  
 Features Double-walled | Doppelwandig



**ALPHA 63570**

Decanter Carafe | Dekantierkaraffe  
 Dimensions H 26,5 cm, Ø 18 cm  
 Materials SSm, Gk, K4



**DELTA 63482**

Decanter Carafe | Dekantierkaraffe  
 Dimensions H 25,5 cm, Ø 18 cm  
 Materials SSm, Gk, K4



**DELTA & ALPHA**

The wine is being filtered and aerated while pouring it into the carafe. The wine can then be poured into the glass with no need to clean the built in sieve. All residue remains in the sieve.

**DELTA & ALPHA**

Der Wein wird beim Befüllen der Karaffe durch die Öffnung aus Edelstahl von Kork und Depot gefiltert und belüftet. Ohne das integrierte Sieb säubern zu müssen, kann der Wein einfach und tropffrei ausgegossen werden und der Weinstein verbleibt im Sieb.

## DINING ESSENTIALS

### LAGONA 66926

# Felt Placemat | Filz Platzset  
 Dimensions H 0,4 cm, B 48,5 cm, T 35 cm  
 Materials T4  
 Colour Micro Chip  
 Features Waterproof and heat resistant  
 Wasserfest und hitzebeständig



66926  
Micro Chip



66925  
Fungi



66924  
Rustic Brown



66923  
Magnet



### LINEO 64445

Placemat | Platzset  
 Dimensions B 35 cm, T 45 cm  
 Materials T1  
 Colour Tan  
 Features STANDARD 100 by OEKO-TEX®



64445  
Moonbeam



64442  
Mirage Gray



64444  
Fungi



64441  
Tan



64446  
Cedar Wood



64443  
Magnet



### LINEO – SLUB GARMENT WASHED BEAUTY

Suiting the LINEO napkin colours, these placemats are a worthy addition. The placemats are woven from rough, prewashed Slub Cotton strings, with little fringes on the rim.

After washing, the appearance may change, but this shows the beauty of this rough material. Just stretch still wet in shape and enjoy a living piece of textile.

- 100% Cotton, OEKOTEX® STANDARD 100
- Wash at 40°C with similar colours
- Do not tumble dry
- Stretch into shape while wet
- May shrink up to 5%

### LINEO – GROB GEWEBTE SCHÖNHEIT

Passend zu den Farben der Stoffservietten LINEO sind diese Platzsets eine würdige Ergänzung. Die Tischsets sind aus vorgewaschenen grob gewebten Baumwollfäden mit kleinen Fransen am Rand.

Nach dem Waschen kann sich das Aussehen verändern, wodurch die Schönheit dieses rauhen Materials erst recht hervorgehoben wird. Einfach nass in Form ziehen und ein lebendiges Stück Textil genießen.

- 100% Baumwolle, OEKOTEX® STANDARD 100
- Waschen bei 40°C mit ähnlichen Farben
- Nicht im Trockner trocknen
- Im nassen Zustand in Form bringen
- Kann bis zu 5% schrumpfen

**LINEO 64265**

Linen Napkin | Leinen-Serviette  
 Dimensions B 42 cm, T 42 cm  
 Materials T5  
 Colour White



<p><b>64265</b> White</p>		<p><b>64806</b> Transparent Yellow</p>		<p><b>64804</b> Moonbeam/Mocha Mousse</p>	
<p><b>63728</b> Moonbeam</p>		<p><b>63730</b> Micro Chip</p>		<p><b>64376</b> Tradewinds</p>	
<p><b>64375</b> Key Largo</p>		<p><b>63727</b> Magnet</p>		<p><b>64163</b> Mirage Gray</p>	
<p><b>64805</b> Agave Green/Pine Grove</p>		<p><b>63726</b> Agave Green</p>		<p><b>64373</b> Duck Green</p>	
<p><b>63729</b> Fungi</p>		<p><b>64266</b> Misty Rose</p>		<p><b>64374</b> Cedar Wood</p>	
<p><b>64372</b> Tan</p>		<p><b>64808</b> Mocha Mousse</p>		<p><b>64807</b> Port</p>	
<p><b>64264</b> Black</p>					



## DINING ESSENTIALS

### TAULO 64872

Set of 2 Tea Towels | Set 2 Geschirrtücher  
Dimensions B 50 cm, T 70 cm  
Materials T1 (Organic)  
Colour White/Mourning Dove  
Features 100% Organic Cotton, 200 g/m<sup>2</sup>  
100% Bio-Baumwolle, 200 g/m<sup>2</sup>

NEW



### TAULO 64873

Set of 2 Tea Towels | Set 2 Geschirrtücher  
Dimensions B 50 cm, T 70 cm  
Materials T1 (Organic)  
Colour White/Mourning Dove  
Features 100% Organic Cotton, 200 g/m<sup>2</sup>  
100% Bio-Baumwolle, 200 g/m<sup>2</sup>

NEW



### TAULO TEA TOWELS

TAULO tea towels are made from 100% GOTS-certified cotton, they come in a set of two with harmonious patterns.

### TAULO GESCHIRRTÜCHER

Die TAULO Geschirrtücher werden aus 100% GOTS-zertifizierter Baumwolle gefertigt und erscheinen im Set mit zwei harmonischen Mustern.



### TAULO 64874

Set of 2 Tea Towels | Set 2 Geschirrtücher  
Dimensions B 50 cm, T 70 cm  
Materials T1 (Organic)  
Colour White/Desert Sage  
Features 100% Organic Cotton, 200 g/m<sup>2</sup>  
100% Bio-Baumwolle, 200 g/m<sup>2</sup>

NEW



### TAULO 64875

Set of 2 Tea Towels | Set 2 Geschirrtücher  
Dimensions B 50 cm, T 70 cm  
Materials T1 (Organic)  
Colour White/Desert Sage  
Features 100% Organic Cotton, 200 g/m<sup>2</sup>  
100% Bio-Baumwolle, 200 g/m<sup>2</sup>

NEW



**GANO 64454**

# Tea Towel, Set of 2 pcs | Set 2 Geschirrtücher  
 Dimensions B 50 cm, T 70 cm  
 Materials T1 (ORGANIC)  
 Colour Moonbeam/Mourning Dove  
 Features ORGANIC Cotton, garment washed  
 Bio-Baumwolle, vorgewaschen



**GANO 64450**

Dish Cloth, Set of 2 pcs | Set 2 Spültücher  
 Dimensions B 25 cm, T 25 cm  
 Materials T1 (ORGANIC)  
 Colour Moonbeam/Mourning Dove  
 Features ORGANIC Cotton, garment washed  
 Bio-Baumwolle, vorgewaschen



**PRACTICAL AND AESTHETIC – GANO**

Naturally beautiful and made from organic cotton, our GANO tea towels and dishcloths come in a set of two in different colour combinations. Each set consists of two different patterns. The pre-washed, fine waffle pique made of organic cotton, with its three-dimensional structure, ensures high absorbency and dries quickly.

**PRAKTISCH UND ÄSTHETISCH – GANO**

Natürlich schön und aus Bio-Baumwolle, unsere GANO Geschirr- und Spültücher im 2er Set in verschiedenen Farbkombinationen. Jedes Set besteht aus den zwei verschiedenen Mustern. Das vorgewaschene, feine Waffelpiqué aus Bio-Baumwolle sorgt durch seine dreidimensionale Struktur für eine hohe Saugfähigkeit und trocknet schnell.



## DINING ESSENTIALS

### ILO 64257

Bottle Opener | Kapselheber  
 Dimensions H 1,5 cm, B 3,5 cm, T 14 cm  
 Materials SSv  
 Colour Magnet



### ILO 64263

Set of 2 Wine Accessories | 2er Set Wein-Accessoires  
 Materials SSv, K3, K4  
 Colour Magnet  
 Features Wine Pourer and Bottle Stop  
 Weinausgießer und Flaschenverschluss



### ILO 64262

Set of 4 Wine Accessories | 4er Set Wein-Accessoires  
 Materials SSv, K3, K4  
 Colour Magnet  
 Features Corkscrew, Bottle Opener, Wine Pourer and Bottle Stop | Korkenzieher, Kapselheber, Weinausgießer und Flaschenverschluss



### ILO 64250

Bottle Opener | Kapselheber  
 Dimensions H 1,5 cm, B 3,5 cm, T 14 cm  
 Materials SSv  
 Colour Moonbeam



### ILO 64256

Set of 2 Wine Accessories | 2er Set Wein-Accessoires  
 Materials SSv, K3, K4  
 Colour Moonbeam  
 Features Wine Pourer and Bottle Stop  
 Weinausgießer und Flaschenverschluss



### ILO 64255

Set of 4 Wine Accessories | 4er Set Wein-Accessoires  
 Materials SSv, K3, K4  
 Colour Moonbeam  
 Features Corkscrew, Bottle Opener, Wine Pourer and Bottle Stop | Korkenzieher, Kapselheber, Weinausgießer und Flaschenverschluss



### ILO ACCESSORIES

Created by the design studio kaschkasch, the ILO series comprises items, that make enjoying wine a special experience. The joy of the products is also reflected in the name ILO, which means joy in Finnish.

Functional and harmonious in their form, the accessories are available in two different colours. The items come in high-quality packaging, making them the ideal gift for any occasion.

### ILO ACCESSOIRES

Die Serie ILO vom Designstudio kaschkasch umfasst Artikel, die den Weingenuss zu einem besonderen Erlebnis machen. Die Freude an den Produkten spiegelt sich auch in der Bezeichnung ILO wieder, was Freude im Finnischen bedeutet.

Funktional und harmonisch in ihrer Form sind die Accessoires in zwei unterschiedlichen Farben verfügbar. Die Artikel kommen in einer hochwertigen Verpackung, sodass sie das ideale Geschenk zu jeder Gelegenheit sind.

### EASY 68237

Bottle Cooler | Flaschenkühler  
 Dimensions H 19,5 cm, Ø 12 cm  
 Materials SSm  
 Features Double-walled  
 Doppelwandig



**EASY 64274**

Bottle Cooler | Flaschenkühler  
 Dimensions H 19,5 cm, Ø 12 cm  
 Materials SSm, SSt  
 Colour Black  
 Features Double-walled  
 Doppelwandig



**LEVERMAN PRO 63598**

Automatic Corkscrew | Automatischer Korkezieher  
 Dimensions H 14,5 cm, B 14 cm, T 3 cm  
 Materials K3, Sc  
 Features With built in foil cutter,  
 with replacement spiral  
 Mit integriertem Folienschneider,  
 mit Ersatzspirale



**UTILO 63145**

Bottle Opener | Kapselheber  
 Dimensions B 16,5 cm, Ø 1,5 cm  
 Materials SSm, K3  
 Colour Black



**EASY 64275**

Bottle Cooler | Flaschenkühler  
 Dimensions H 19,5 cm, Ø 12 cm  
 Materials SSm, SSt  
 Colour Moonbeam  
 Features Double-walled  
 Doppelwandig



**LEVERMAN PRO 64276**

Automatic Corkscrew | Automatischer Korkezieher  
 Dimensions H 14,5 cm, B 14 cm, T 3 cm  
 Materials K3, Sc  
 Colour Moonbeam  
 Features With built in foil cutter,  
 with replacement spiral  
 Mit integriertem Folienschneider,  
 mit Ersatzspirale



**UTILO 64288**

Bottle Opener | Kapselheber  
 Dimensions L 16,5 cm, Ø 1,5 cm  
 Materials SSm, K3  
 Colour Moonbeam



**LARETO 64065**

Set of 6 Coasters | Set 6 Untersetzer  
 Dimensions H 4 cm, Ø 11,5 cm  
 Materials SSm, K4  
 Colour Moonbeam



**LARETO 64062**

Set of 6 Coasters | Set 6 Untersetzer  
 Dimensions H 4 cm, Ø 11,5 cm  
 Materials SSm, K4  
 Colour Magnet



**LARETO 63476**

Set of 6 Coasters | Set 6 Untersetzer  
 Dimensions H 4 cm, Ø 11,5 cm  
 Materials SSm, K4  
 Colour Black



## DINING ESSENTIALS

### KANKYO 67086

Tray | Tablett

Dimensions H 5 cm, B 30 cm, T 46 cm

Materials MM1

Colour Moonbeam

Features 65% Recycled Bamboo, 35% Resin  
65% recyceltes Bambus, 35% Harz



### KANKYO 67085

Tray | Tablett

Dimensions H 5 cm, B 30 cm, T 46 cm

Materials MM1

Colour Mourning Dove

Features 65% Recycled Bamboo, 35% Resin  
65% recyceltes Bambus, 35% Harz



### KANKYO – DESIGN BY PETER LIENHART

Both practical and stylish, it is the ideal addition to your home and a conscious choice for your everyday needs. The tray is available in two colours. The tray is partly made of bamboo fibres, which are visible and noticeable on the surface and give it a unique look.

Care instructions: To preserve the look and material for as long as possible, we recommend cleaning this item with a damp cloth.

### KANKYO – DESIGN VON PETER LIENHART

Praktisch und stilvoll zugleich ist es die ideale Ergänzung für Ihr Zuhause und eine bewusste Wahl für Ihre täglichen Bedürfnisse. Das Tablett ist in zwei Farben erhältlich. Das Tablett besteht zu Teilen aus Bambusfasern, die in der Oberfläche sichtbar und spürbar sind und ihm einen einzigartigen Look verleihen.

Pflegehinweis: Um den Look und das Material möglichst lange zu erhalten, empfehlen wir für diesen Artikel die Reinigung mit einem feuchten Tuch.

**ABENTO 64190**

Tray | Tablett  
 Dimensions H 5 cm, B 18 cm, T 30 cm  
 Materials H1  
 Colour Natural  
 Features Size: S



64190  
Natural



64438  
Black



**ABENTO TRAY – DESIGN BY AD MILLER**

The ABENTO Tray design is inspired by the clean lines of Japanese wood-working. The two legs intersect the body of the tray to create 3 sections. The tray is sized to allow for easy everyday use. When not used for serving, the tray serves perfectly as a decorative piece. The tray comes in 2 sizes. Care instructions: wipe with a moist tissue, rub dry and let it continue to air dry.

**ABENTO TABLETT – DESIGN VON AD MILLER**

Das Design der ABENTO Tablettts ist von den klaren Linien der japanischen Holzverarbeitung inspiriert. Die beiden Standfüße, welche ein einfaches Greifen ermöglichen, kreuzen den Korpus des Tablettts und unterteilen zugleich die Ablagefläche in 3 Abschnitte. Somit wird für eine gute Handhabung im täglichen Gebrauch gesorgt. Wenn das Tablett nicht zum Servieren verwendet wird, eignet es sich insbesondere zum Dekorieren. Es ist in 2 Größen erhältlich. Pflegehinweis: Zur Reinigung das Tablett feucht abwischen, abtrocknen und an der Luft weiter trocknen lassen.

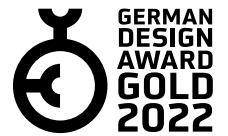

**ABENTO 64191**

Tray | Tablett  
 Dimensions H 8,5 cm, B 30 cm, T 50 cm  
 Materials H1  
 Colour Natural  
 Features Size: L



64191  
Natural



64437  
Black



**WILO 63905**

Tray | Tablett  
 Dimensions H 3,5 cm, B 25 cm, T 35,5 cm  
 Materials H1  
 Colour Natural  
 Features With anti-slip surface  
 Mit rutschhemmender Oberfläche, Size: S



63905  
Natural



64439  
Black



**WILO 63906**

Tray | Tablett  
 Dimensions H 4,5 cm, B 31 cm, T 43 cm  
 Materials H1  
 Features With anti-slip surface  
 Mit rutschhemmender Oberfläche, Size: L



63906  
Natural



64440  
Black







**PEPE 64697**

Salt & Peppermill | Salz- & Pfeffermühle  
 Dimensions H 15 cm, Ø 5,5 cm  
 Materials H2I, ST2  
 Colour Oak  
 Features With ceramic grinder  
 Mit Keramikmahlwerk



**PEPE SALT & PEPPERMILL**

Discover the perfect duo for your kitchen: the high-quality salt and pepper mills from blomus. This set of 2, made from clear lacquered oak wood, combines style and functionality in a timeless design. The integrated ceramic grinder, which is infinitely adjustable, ensures precise grinding – just the way you like it. The grinders are robust, durable and easy to clean. Thanks to the removable lid, they can be refilled effortlessly from above. The aluminium ring, which visually separates the lid and body, creates an elegant accent, while the laser-engraved blomus logo and the S and P markings for salt and pepper allow clear identification. Naturally tested for food safety, these mills fulfil the highest quality standards.

**PEPE SALZ- & PFEFFERMÜHLE**

Entdecken Sie das perfekte Duo für Ihr kulinarisches Zuhause: die hochwertigen Salz- und Pfeffermühlen von blomus. Dieses 2er Set, gefertigt aus klar lackiertem Eichenholz, vereint Stil und Funktionalität in einem zeitlosen Design. Das integrierte Keramikmahlwerk, welches stufenlos einstellbar ist, sorgt für präzises Mahlen – ganz nach Ihrem Geschmack. Die Mühlen sind robust, langlebig und pflegeleicht. Dank des abnehmbaren Deckels lassen sie sich mühelos von oben befüllen. Der Aluminiumring, der Deckel und Körper optisch trennt, setzt einen eleganten Akzent, während das gelaserte blomus-Logo und die S- und P-Markierungen für Salz und Pfeffer eine klare Zuordnung ermöglichen. Natürlich auf Lebensmittelechtheit geprüft, erfüllen diese Mühlen höchste Qualitätsstandards.



**MOLI SALT & PEPPERMILL**

Bring style and functionality to your dining table with the high-quality salt and pepper mill set from blomus. Made from colour-lacquered ash wood, this 2-piece set in the colours Moonbeam and Nomad combines timeless design with the highest quality. The integrated ceramic grinder is infinitely adjustable and allows you to achieve the perfect grinding result, whether for fine salt or coarse pepper. The sculptural, slightly playful yet stringent design is stylishly rounded off by the laser-engraved blomus logo and the S and P markings. Robust, durable and easy to clean – the grinders can be refilled from the top and are fitted with a removable lid. Naturally tested for food safety, they fulfil the highest standards and are a special eye-catcher on any table.

**MOLI SALZ- & PFEFFERMÜHLE**

Bringen Sie Stil und Funktionalität auf Ihren Esstisch mit dem hochwertigen Salz- und Pfeffermühlen-Set von blomus. Gefertigt aus farbig lackiertem Eschenholz, vereint dieses 2-teilige Set in den Farben Moonbeam und Nomad zeitloses Design mit höchster Qualität. Das integrierte Keramikmahlwerk ist stufenlos einstellbar und ermöglicht Ihnen das perfekte Mahlergebnis, egal ob für feines Salz oder groben Pfeffer. Das skulpturell angehauchte, leicht verspielte, aber dennoch stringente Design wird durch das gelaserte blomus-Logo und die S- und P-Markierungen stilvoll abgerundet. Robust, langlebig und pflegeleicht – die Mühlen sind von oben befüllbar und mit einem abnehmbaren Deckel ausgestattet. Auf Lebensmittelechtheit geprüft, erfüllen sie höchste Ansprüche und sind ein besonderer Hingucker auf jedem Tisch.

**MOLI 64698**

Salt & Peppermill | Salz- & Pfeffermühle  
 Dimensions H 13 cm, Ø 6 cm  
 Materials H71, ST2  
 Colour Moonbeam/Nomad  
 Features With ceramic grinder  
 Mit Keramikmahlwerk



**SALPI 63959**

Salt- & Peppermill | Salz- & Pfeffermühle  
 Dimensions H 20 cm, Ø 7 cm  
 Materials K3, ST2  
 Colour Nomad/Moonbeam  
 Features With ceramic grinder  
 Mit Keramikmahlwerk

**63959**  
Nomad/Moonbeam



**63960**  
Sharkskin/Magnet





#### LITO BOWLS

The LITO Bowls by Nina Thöming of Flöz Design are a perfect addition to our classics – the LITO Lanterns. The elegant bowls can be used as fruit bowls in your kitchen, as decorative bowls in the living room or as a bread basket. The powder-coated struts make the design unmistakable and give the bowl a lightness and filigree, yet it is very robust and therefore a durable container for your uses and shows that stability and delicacy are in no way contradictory.

#### LITO SCHALEN

Die LITO Bowls von Nina Thöming von Flöz Design sind eine perfekte Ergänzung unserer Klassiker – die LITO Laternen. Die eleganten Schalen können als Obstschalen in Ihrer Küche, als Dekoschale im Wohnzimmer oder als Brotkorb verwendet werden. Die pulverbeschichteten Streben machen das Design unverkennbar und geben der Schale eine Leichtigkeit und Filigran, dennoch ist sie sehr robust und damit ein langlebiges Behältnis für Ihre Verwendungen und zeigt, dass Stabilität und Feingliedrigkeit keines Falls im Widerspruch zueinanderstehen.

**LITO 64706**

Bowl | Schale  
 Dimensions H 8 cm, Ø 20 cm  
 Materials Sb  
 Colour White  
 Features Food safe  
 Lebensmittelecht, Size: S



64706  
White



64707  
Nomad



64708  
Mourning Dove



64709  
Steel Gray



64705  
Black



**LITO 64689**

Bowl | Schale  
 Dimensions H 9,5 cm, Ø 25 cm  
 Materials Sb  
 Colour White  
 Features Food safe  
 Lebensmittelecht, Size: M



64689  
White



64690  
Nomad



64691  
Mourning Dove



64692  
Steel Gray



64552  
Black



**LITO 64693**

Bowl | Schale  
 Dimensions H 8,5 cm, Ø 36 cm  
 Materials Sb  
 Colour White  
 Features Food safe  
 Lebensmittelecht, Size: L



64693  
White



64694  
Nomad



64695  
Mourning Dove



64696  
Steel Gray



64553  
Black



## DINING ESSENTIALS

### DELARA 63758

Bread Basket | Brotkorb  
 Dimensions H 9 cm, B 26 cm, T 26 cm  
 Materials Sc, T1  
 Colour Moonbeam

63758  
Moonbeam



63763  
Magnet



63668  
Taupe



### DELARA 64075

Bread Basket | Brotkorb  
 Dimensions H 9 cm, B 26 cm, T 26 cm  
 Materials Sb, T1  
 Colour Moonbeam

64075  
Moonbeam



64072  
Magnet



### DELARA 63871

Bread Basket | Brotkorb  
 Dimensions H 9,5 cm, B 20 cm, T 20 cm  
 Materials Sb, T1  
 Colour Black



### DELARA 63872

Bread Basket | Brotkorb  
 Dimensions H 9 cm, B 26 cm, T 26 cm  
 Materials Sb, T1  
 Colour Black



### DELARA BREADBASKET

Care: The cotton insert can be easily removed for shaking clean or washing.

### DELARA BROTKORB

Pflege: Der Einsatz kann zum Ausschütteln und Waschen einfach herausgenommen werden.

### NAVETTA 63565

Cheese Grater with Bowl |  
 Käseibe mit Auffangschale  
 Dimensions H 17 cm, B 10 cm, T 19,5 cm  
 Materials SSp, K3



### ALINJO 63509

Oil & Vinegar Set | Essig und Öl Set  
 Dimensions H 17 cm, Ø 5,5 cm, V 150 ml  
 Materials SSm, Gk



### MACCHIATO 63510

Sugar & Creamer Set | Zucker- und Sahne Set  
 Dimensions H 17 cm, Ø 5,5 cm, V 150 ml  
 Materials SSm, Gk



**BASIC 63618**

Creamer with stainless steel lid |  
Sahnekännchen mit Edelstahldeckel  
Dimensions H 8 cm, B 5,5 cm, Ø 5 cm, V 120 ml  
Materials SSm



**BASIC 63620**

Creamer with stainless steel lid |  
Milchkännchen mit Edelstahldeckel  
Dimensions H 9,5 cm, H 7,5 cm, Ø 6,5 cm,  
V 250 ml  
Materials SSm



**BASIC 63621**

Sugar Bowl with stainless steel lid |  
Zuckerdose mit Edelstahldeckel  
Dimensions H 5 cm, Ø 6,5 cm, V 100 ml  
Materials SSm



**BASIC 63619**

Condiment Glass with stainless steel lid |  
Marmeladenglas mit Edelstahldeckel  
Dimensions H 5 cm, Ø 6,5 cm, V 100 ml  
Materials SSm, Gk



**BASIC 63633**

Snack Bowl | Snackschale  
Dimensions H 5,5 cm, Ø 8 cm, V 220 ml  
Materials SSm  
Features Size: S



**BASIC 63634**

Snack Bowl | Snackschale  
Dimensions H 4 cm, Ø 10 cm, V 250 ml  
Materials SSm  
Features Size: M



**BASIC 63637**

Single Butter Dish | Butterdose  
Dimensions H 6 cm, B 7 cm, T 10 cm  
Materials SSm, SSp  
Features For 125 g butter  
Für 125 g Butter



**BASIC 63638**

Butter Dish | Butterdose  
Dimensions H 6 cm, B 12 cm, T 10 cm  
Materials SSm, SSp  
Features For 250 g butter  
Für 250 g Butter



**BASIC 63610**

Tray | Tablett  
Dimensions H 1,5 cm, B 10 cm, T 17 cm  
Materials SSm



**BASIC 63611**

Tray | Tablett

Dimensions H 1,5 cm, B 13 cm, T 22 cm

Materials SSm



**BASIC 63612**

Tray | Tablett

Dimensions H 1,5 cm, B 15 cm, T 25 cm

Materials SSm



**BASIC 63613**

Tray | Tablett

Dimensions H 1,5 cm, B 17 cm, T 20 cm

Materials SSm



**CALLISTA 63480**

Lemon Squeezer | Zitronenpresse

Dimensions H 6 cm, B 9 cm, T 17,5 cm

Materials SSp



**LOUNGE 63539**

Set of 4 Stainless Steel Ice Cubes | Set 4 Eiswürfel

Dimensions H 2,5 cm, B 2,5 cm, T 2,5 cm

Materials SSp, T5

Features Chills the beverage without diluting it, incl. Linen bag

Kühlt ohne zu verwässern, inkl. Aufbewahrungsbeutel



**PUNCTO 63600**

Kitchen Timer | Kurzzeitmesser  
 Dimensions H 6 cm, Ø 6,5 cm  
 Materials SSm, K3



**LOOP 63651**

Paper Towel Holder | Küchenrollenhalter  
 Dimensions H 34 cm, Ø 15 cm  
 Materials SSm, K3, K1  
 Features Single-handed use, Unroll protection spring | Für Einhand-Bedienung, mit Abrollschutz



**LOOP 64364**

Kitchen Towel Holder | Küchenrollenhalter  
 Dimensions H 34 cm, Ø 15 cm  
 Materials SSb, K3, K1  
 Colour Black  
 Features Single-handed use, Unroll protection Spring | Für Einhand-Bedienung, mit Abrollschutz



**PILARE 65776**

Wine Bottle Storage | Weinflaschenregal  
 Dimensions H 67 cm, B 19 cm, T 22 cm  
 Materials Sb  
 Features Holds 12 Bottles  
 Für 12 Flaschen

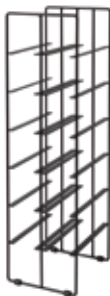

**PILARE 68486**

Wine Bottle Storage | Weinflaschenregal  
 Dimensions H 66 cm, B 19 cm, T 22 cm  
 Materials Sn  
 Features Holds 12 Bottles  
 Für 12 Flaschen



**LOOP 64365**

Kitchen Towel Holder | Küchenrollenhalter  
 Dimensions H 34 cm, Ø 15 cm  
 Materials SSb, K3, K1  
 Colour Moonbeam  
 Features Single-handed use, Unroll protection Spring | Für Einhand-Bedienung, mit Abrollschutz



**TEA-JAY 63537**

Iced Tea Maker | Eistee-Zubereiter  
 Dimensions H 30,5 cm, Ø 9,5 cm, V 800 ml  
 Materials SSm, Gk, K4



**TEA-JAY**

Prepare delicious iced tea quickly and simply. Take the iced tea maker with you to the table and share the experience of converting juice, syrup, fruit and tea to a delicious iced tea with your guests. Once the hot tea is poured over the ice cubes, the ice cubes melt and the iced tea can instantly be served while the tea leaves remain separated in the reservoir.

**TEA-JAY**

Schnell und unkompliziert echten Eistee zubereiten. Nehmen Sie den Eisteezubereiter mit an den Tisch, teilen Sie das Erlebnis mit Ihren Gästen, wenn aus Saft, Sirup, Früchten und Tee ein leckerer Eistee wird. Sobald der heiße Tee aus dem Filter über das Eis fließt, schmelzen die Eiswürfel und der kalte Eistee kann sofort serviert werden, während die benutzten Teeblätter ohne weiteren Kontakt im Filter verbleiben.





**CLEAN CUCUMBER**

Clean Cucumber fragrance is a vegan product that whisks you away to a refreshing oasis with the invigorating scent of fresh cucumber. This unique fusion combines the crisp aroma of cucumber with its cool and rejuvenating essence.

**CLEAN CUCUMBER**

Der Duft Clean Cucumber ist ein veganes Produkt, das Sie mit dem belebenden Duft von frischer Gurke in eine erfrischende Oase entführt. Diese einzigartige Mischung kombiniert das frische Aroma der Gurke mit ihrer kühlen und verjüngenden Essenz.

**SATOMI 65188**

Dishwashing Soap | Geschirrspülmittel  
 Dimensions H 16 cm, Ø 8 cm, V 500 ml  
 Features Scent Clean Cucumber, 25% organic Aloe Vera, 95% natural ingredients  
 Duft Clean Cucumber, 25% Bio Aloe Vera, 95% natürliche Inhaltsstoffe



**SATOMI 65207**

Refill Dishwashing Soap |  
 Geschirrspülmittel Nachfüllpack  
 Dimensions V 1 l  
 Features Scent Clean Cucumber, 25% organic Aloe Vera, 95% natural ingredients  
 Duft Clean Cucumber, 25% Bio Aloe Vera, 95% natürliche Inhaltsstoffe



**ARJA**

The ARJA dishwashing brush not only impresses with its modern design, but also with its high-quality workmanship and easy-care materials. The replaceable head makes it particularly practical, as only the worn part needs to be replaced. Thanks to its low weight, it fits perfectly in the hand and enables fatigue-free working. It can also be cleaned in the dishwasher.

**ARJA**

Die ARJA Spülbürste überzeugt nicht nur durch ihr modernes Design, sondern auch durch ihre hochwertige Verarbeitung und pflegeleichten Materialien. Der austauschbare Kopf macht sie besonders praktisch, da nur der abgenutzte Teil ersetzt werden muss. Dank des geringen Gewichts liegt sie perfekt in der Hand und ermöglicht ein ermüdungsfreies Arbeiten. Außerdem kann sie in der Spülmaschine gereinigt werden.

**ARJA 64562**

Dishwashing Brush | Spülbürste  
 Dimensions H 4cm, B 21,5 cm, Ø 5 cm  
 Materials SSb, K3  
 Colour Black  
 Features Replaceable head  
 Austauschbarer Kopf



**ARJA 88340**

Replaceable Head Dishwashing Brush |  
 Wechselkopf Spülbürste  
 Dimensions H 4 cm, B 5 cm  
 Materials K3  
 Colour Black



**PIRO 64557**

Dishwashing Set | Spülset  
 Dimensions H 10 cm, B 17,5 cm, T 9,5 cm  
 Materials ST2  
 Colour Moonbeam



64557 Moonbeam



64555 Satellite



64554 Black



64556 Nomad





#### PIRO DISHWASHING SET

Organize your kitchen in style with the PIRO kitchen set. The mug made of high-quality stoneware with the integrated shelf brings a touch of order and aesthetics to the kitchen. Specially designed for the SATOMI series, the dishwashing liquid can be ideally placed on the tray.

The grooves in the tray ensure that soap and washing-up liquid always stay dry. There is space for a dishwashing brush in the attached cup. Our ARJA dishwashing brush is ideal for this, which forms a harmonious unit when combined with PIRO.

#### PIRO SPÜLSET

Die Küche stilvoll organisieren mit dem Küchenset PIRO. Der aus hochwertigem Steingut bestehende Becher mit der integrierten Ablagefläche, bringt ein Stück Ordnung und Ästhetik in die Küche. Speziell design für die SATOMI Serie, kann das Geschirrspülmittel ideal auf der Ablagefläche platziert werden.

Die im Tray angebrachten Rillen sorgen dafür, dass Seife oder Geschirrspülmittel stets trocken stehen. Im angehängten Becher findet eine Spülbürste ihren Platz. Hierfür bietet sich unsere Spülbürste ARJA an, welche in der Kombination mit PIRO eine harmonische Einheit bildet.



**BORDA 63794**

Cutting Board | Schneidbrett  
 Dimensions H 1,5 cm, B 15 cm, T 44 cm  
 Materials H2



**ZEN 64360**

Tray/Cutting Board | Tablett/Schneidbrett  
 Dimensions H 2 cm, B 17 cm, T 32 cm  
 Materials H2  
 Features Usable on both sides  
 Beidseitig verwendbar, Size: M



**BORDA 63793**

Cutting Board | Schneidbrett  
 Dimensions H 2 cm, B 18 cm, T 64 cm  
 Materials H2



**ZEN 64361**

Tray/Cutting Board | Tablett/Schneidbrett  
 Dimensions H 2 cm, B 25 cm, T 40 cm  
 Materials H2  
 Features Usable on both sides  
 Beidseitig verwendbar, Size: L



**BORDA 63797**

Cutting Board | Schneidbrett  
 Dimensions H 1,5 cm, Ø 30 cm  
 Materials H2



**OOLONG 63773**

Trivet | Untersetzer  
 Dimensions H 0,5 cm, Ø 14 cm  
 Materials SSm, K4  
 Colour Moonbeam

63773  
Moonbeam



63778  
Magnet





PRODUCTS

---

# LIVING ESSENTIALS

FURNITURE	P. 122
LIGHTING	P. 156
TEXTILE	P. 160
DECORATION	P. 168
FUNCTIONAL OBJECTS	P. 192

**SITTA 67083**

# Sofa | Sofa

Dimensions H 70 cm, B 135 cm, T 55 cm

Materials T3, T8

Colour Shitake

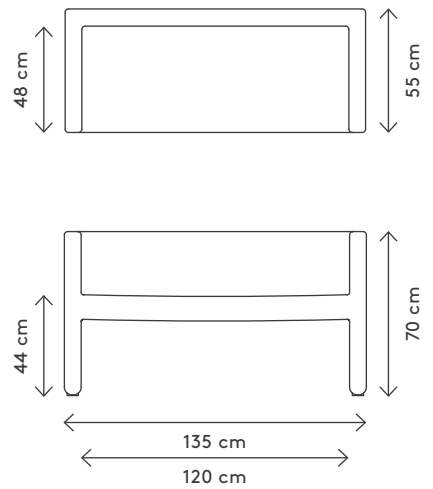

**SITTA 67084**

# Bench | Bank

Dimensions H 46 cm, B 113 cm, T 38 cm

Materials T3, T8

Colour Shitake

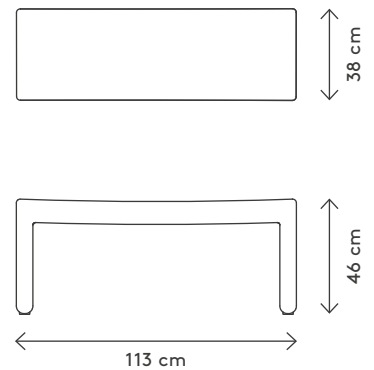

**SITTA**

With the SITTA line, Anton Björnsing has added a new dimension and various possibilities of use and design to the elegant simplicity of this furniture. Slim proportions and minimalist principles – the pieces exude elegant and clean lines in their simple details. Upholstered elements that convey a sense of softness and add a tactile touch to modern spaces. With its elegant simplicity, this furniture offers you a new dimension to use it and enrich your living space.

**SITTA**

Mit der Serie SITTA hat Anton Björnsing die elegante Schlichtheit, die diese Möbel mit sich bringen, mit einer neuen Dimension und verschiedenen Möglichkeiten der Nutzung und Gestaltung versehen. Schlanke Proportionen und minimalistische Prinzipien – die Stücke strahlen elegante und klare Linien in ihren einfachen Details aus. Gepolsterte Elemente, die ein Gefühl von Weichheit vermitteln und modernen Räumen eine taktile Note verleihen. Mit ihrer eleganten Einfachheit bieten diese Möbel Ihnen eine neue Dimension sie zu nutzen und Ihren Wohnraum zu bereichern.



The QR code leads you to the SITTA Product Fact Sheet.  
Der QR-Code führt Sie zu dem SITTA Product Fact Sheet.







# Pallet delivery only. Nur Palettenversand.



## KUON

A rounded shape, inviting and comfortable. This is also how you can describe the extension to the KUON series – the KUON chaiselongue. Whether as a stand-alone, free-standing piece of furniture that invites you to relax and read a magazine, or as part of a KUON arrangement for a cosy get-together, the KUON chaise longue, designed by Japanese designer Kazushige Miyake, is a real eye-catcher. Made in Poland from high-quality, durable materials and components, the KUON chaiselongue has the potential to become your new favourite piece of furniture. Available in two different fabric qualities and two colour variants.

## KUON

Eine rundliche Form, einladend und bequem. So kann man auch die Erweiterung der KUON Serie beschreiben – die KUON Chaiselongue. Sei es als eigenständiges, freistehendes Möbelstück, welches Sie zum entspannten Magazin lesen einlädt, oder als Teil eines KUON Arrangements für ein gemütliches miteinander, die KUON Chaiselongue, entworfen vom japanischen Designer Kazushige Miyake, ist ein echter Hingucker. Die in Polen, aus hochwertigen und langlebigen Materialien, sowie Bauteilen gefertigte KUON Chaiselongue hat das Potential zu Ihrem neuen Lieblingseinrichtungsstück zu werden. Erhältlich in zwei verschiedenen Stoffqualitäten, sowie jeweils zwei Farbvarianten.



The QR code leads you to the KUON Product Fact Sheet.  
Der QR-Code führt Sie zu dem KUON Product Fact Sheet.



**KUON 67300**

# Chaiselongue | Chaiselongue  
 Dimensions H 71 cm, B 160 cm, T 69 cm  
 Materials H2, T3  
 Colour Desert  
 Features Seat depth | Sitztiefe: 52 cm  
 Seat height | Sitzhöhe: 45 cm



**67300**  
 Socia - Desert



**67301**  
 Socia - Taupe



**67302**  
 Boucla - Beige



**67303**  
 Boucla - Shitake

**KUON 68030**

# Chaiselongue | Chaiselongue  
 Dimensions H 71 cm, B 160 cm, T 69 cm  
 Materials H2, T3  
 Colour Desert  
 Features Seat depth | Sitztiefe: 52 cm  
 Seat height | Sitzhöhe: 45 cm



**68030**  
 Socia - Desert



**68031**  
 Socia - Taupe



**68032**  
 Boucla - Beige



**68033**  
 Boucla - Shitake

**KUON 66942**

# 2 Seater Sofa | 2-Sitzer Sofa  
 Dimensions H 71 cm, B 137,5 cm, T 69 cm  
 Materials H2, T3  
 Colour Desert  
 Features Seat depth | Sitztiefe: 52 cm  
 Seat height | Sitzhöhe: 45 cm



**66942**  
 Socia - Desert



**66989**  
 Socia - Taupe



**66996**  
 Boucla - Beige



**67003**  
 Boucla - Shitake

# Pallet delivery only. Nur Palettenversand.

**KUON 66940**

# Chair | Sessel

Dimensions H 71 cm, B 65 cm, T 63 cm

Materials H2, T3

Colour Desert

Features Seat depth | Sitztiefe: 50 cm  
Seat height | Sitzhöhe: 45 cm



**66940**  
Socia - Desert



**66990**  
Socia - Taupe



**66997**  
Boucla - Beige



**67004**  
Boucla - Shitake

**KUON 66941**

# Swivel Chair | Drehsessel

Dimensions H 71 cm, B 65 cm, T 63 cm

Materials H2, T3

Colour Desert

Features With swivel function, mit Drehfunktion  
Seat depth | Sitztiefe: 50 cm  
Seat height | Sitzhöhe: 45 cm



**66941**  
Socia - Desert



**66991**  
Socia - Taupe



**66998**  
Boucla - Beige



**67005**  
Boucla - Shitake

**KUON 66987**

# Pouf | Pouf

Dimensions H 45 cm, Ø 48 cm

Materials H2, T3

Colour Desert

Features Seat depth | Sitztiefe: 48 cm  
Seat height | Sitzhöhe: 45 cm



**66987**  
Socia - Desert



**66994**  
Socia - Taupe



**67001**  
Boucla - Beige



**67008**  
Boucla - Shitake

**KUON 66988**

# Bench | Bank

Dimensions H 45 cm, B 120 cm, T 40 cm

Materials H2, T3

Colour Desert

Features Seat depth | Sitztiefe: 40 cm  
Seat height | Sitzhöhe: 45 cm,  
Size: S66988  
Socia - Desert66995  
Socia - Taupe67002  
Boucla - Beige67009  
Boucla - Shitake

# Pallet delivery only. Nur Palettenversand.



**NAGOMI 67304**

# Chair | Stuhl  
 Dimensions H 74 cm, B 67 cm, T 59 cm  
 Materials H6  
 Features Incl. Felt glides | Inkl. Filzgleiter



**THE PERFECT PLACE TO REST**

Inspired by the simplicity and elegance of nature, NAGOMI embodies the essence of harmony and comfort. NAGOMI is made of high-quality plywood, with gently curved lines and rounded edges that convey a calming aesthetic. The surface of the chair is flawless and shows the natural grain of the wood, giving the chair an organic and warm appearance. The simple elegance of the design blends seamlessly into any setting and becomes the centerpiece of any interior.

**DER PERFEKTE ORT ZUM AUSRUHEN**

Inspiriert von der Schlichtheit und Eleganz der Natur, verkörpert NAGOMI die Essenz der Harmonie und des Komforts. NAGOMI ist aus hochwertigem Sperrholz gefertigt, mit sanft geschwungenen Linien und abgerundeten Kanten, die eine beruhigende Ästhetik vermitteln. Die Oberfläche des Stuhls ist durch das Eichenfurnier makellos und zeigt die natürliche Maserung des Holzes, was dem Stuhl eine organische und warme Ausstrahlung verleiht. Die einfache Eleganz des Designs fügt sich nahtlos in jedes Ambiente ein und wird zum Mittelpunkt jeder Einrichtung.

**NAGOMI 68374**

Seat Pad | Sitzkissen  
 Dimensions H 0,5 cm, B 56 cm, T 39 cm  
 Materials T4  
 Colour Stone Melange  
 Features Suitable for NAGOMI Chair  
 Geeignet für NAGOMI Stuhl





**RAKKU 67296**

# Coat Stand | Garderobenständer  
 Dimensions H 176 cm, B 62 cm, T 62 cm  
 Materials H2, Sb  
 Colour Oak

**RAKKU 67297**

# Coat Stand | Garderobenständer  
 Dimensions H 176 cm, B 62 cm, T 62 cm  
 Materials H2, Sb  
 Colour Black

**RAKKU – MODERN GEOMETRY MEETS TIMELESS MINIMALISM**

With the coat stand RAKKU, Japanese for rack, designer Kazushige Miyake has created a unique symbiosis between modern geometry and timeless minimalism. The helix-like construction is just as simple as the design. Three wooden slats are almost curved into each other and are held in place by triangular metal elements. Despite the minimalist design, the functionality of this coat stand is by no means in the background. Keys or bags can be placed on a round plate. The three wooden elements provide space for jackets, scarves and hats and hangers can be attached to the metal connections as needed.

The RAKKU coat stand is available in natural or black stained oak and is delivered fully assembled.

**RAKKU – MODERNE GEOMETRIE TRIFFT ZEITLOSE MINIMALISTIK**

Mit dem Garderobenständer RAKKU, japanisch für Gestell, hat der Designer Kazushige Miyake eine einzigartige Symbiose zwischen moderner Geometrie und zeitloser Minimalistik erschaffen. Die helixartig angelegte Konstruktion ist ebenso wie das Design simpel. Drei Holzleisten sind nahezu ineinander geschwungen und werden durch dreieckige Metallelemente fixiert. Trotz des reduzierten Designs steht die Funktionalität dieses Garderobenständers keinesfalls im Hintergrund. Auf einer runden Platte können Schlüssel oder Taschen abgestellt werden. Die drei Holzelemente bieten Platz für Jacken, Schals und Hüte und an den Metallverbindungen können bei Bedarf Kleiderbügel aufgehängt werden.

Der RAKKU Garderobenständer ist in natürlichem oder schwarzem Eichenholz verfügbar und wird vollständig montiert geliefert.

# Pallet delivery only. Nur Palettenversand.





#### SUKOYA SHELF COLLECTION – DESIGN BY KAZUSHIGE MIYAKE

Japanese designer Kazushige Miyake has created the collection of shelves called SUKOYA for blomus. SUKOYA is the Japanese term for a square, the tool used for marking and referencing a 90° angle. The name was chosen in homage to the linear frame design of the shelves. With SUKOYA, your decorative and ornamental objects take center stage and not the shelf itself. At the same time, it offers practical storage space and brings order to your home. SUKOYA is made from FSC®-certified wood and other controlled materials.

#### SUKOYA REGALKOLLEKTION – DESIGN VON KAZUSHIGE MIYAKE

Der japanische Designer Kazushige Miyake hat die Kollektion an Regalen mit dem Namen SUKOYA für blomus entworfen. SUKOYA, der japanische Begriff für ein Quadrat, das Werkzeug, mit dem man einen 90°-Winkel markiert und referenziert, wurde als Hommage an das lineare Rahmendesign der Regale gewählt. Mit SUKOYA stehen Ihre Dekorations- und Ziergegenstände im Fokus – und nicht das Regal selbst. Zeitgleich bietet SUKOYA praktischen Stauraum und bringt Ordnung in Ihr Zuhause. SUKOYA besteht aus FSC®-zertifiziertem Holz und anderen kontrollierten Materialien.



The QR code leads you to the SUKOYA Product Fact Sheet.  
Der QR-Code führt Sie zu dem SUKOYA Product Fact Sheet.



**SUKOYA 67313**

# Shelf | Regal  
 Dimensions H 92 cm, B 105 cm, T 40 cm  
 Materials H2, H10  
 Colour Natural Oiled Oak Veneer  
 Features Including 1 x Shelf Unit Size L, 1 x Shelf Unit Size M, 3 x Shelf Unit Size S  
 Inklusive 1 x Einlegeboden Größe L, 1 x Einlegeboden Größe M, 3 x Einlegeboden Größe S, Size: S

**67313**  
 Natural Oiled Oak Veneer



**67314**  
 White Oiled Oak Veneer



**SUKOYA 67317**

# Shelf | Regal  
 Dimensions H 170 cm, B 105 cm, T 40 cm  
 Materials H2, H10  
 Colour Natural Oiled Oak Veneer  
 Features Including 2 x Shelf Unit Size L, 1 x Shelf Unit Size M, 5 x Shelf Unit Size S  
 Inklusive 2 x Einlegeboden Größe L, 1 x Einlegeboden Größe M, 5 x Einlegeboden Größe S, Size: M

**67317**  
 Natural Oiled Oak Veneer



**67318**  
 White Oiled Oak Veneer



**SUKOYA 67315**

# Shelf | Regal  
 Dimensions H 92 cm, B 104 cm, T 40 cm  
 Materials Sb, H10  
 Colour Nomad, Natural Oiled Oak Veneer  
 Features Including 1 x Shelf Unit Size L, 1 x Shelf Unit Size M, 3 x Shelf Unit Size S  
 Inklusive 1 x Einlegeboden Größe L, 1 x Einlegeboden Größe M, 3 x Einlegeboden Größe S, Size: S

**67315**  
 Nomad, Natural Oiled Oak Veneer



**67316**  
 Nomad, White Oiled Oak Veneer



**SUKOYA 67319**

# Shelf | Regal  
 Dimensions H 170 cm, B 104 cm, T 40 cm  
 Materials Sb, H10  
 Colour Nomad, Natural Oiled Oak Veneer  
 Features Including 2 x Shelf Unit Size L, 1 x Shelf Unit Size M, 5 x Shelf Unit Size S  
 Inklusive 2 x Einlegeboden Größe L, 1 x Einlegeboden Größe M, 5 x Einlegeboden Größe S, Size: M

**67319**  
 Nomad, Natural Oiled Oak Veneer



**67320**  
 Nomad, White Oiled Oak Veneer



# Pallet delivery only. Nur Palettenversand.

**SUKOYA 67353**

Shelf Unit | Regal Einlegeboden  
 Dimensions H 3,5 cm, B 33 cm, T 40 cm  
 Materials H10  
 Colour Natural Oiled  
 Features Suitable for Metal Shelf  
 Geeignet für Metallregal,  
 Size: S



**67353**  
Natural Lacquered

**67356**  
White Lacquered



**SUKOYA 67359**

Shelf Unit | Regal Einlegeboden  
 Dimensions H 2,5 cm, B 33 cm, T 40 cm  
 Materials H10  
 Colour Natural Oiled  
 Features Suitable for Wooden Shelf  
 Geeignet für Holzregal,  
 Size: S

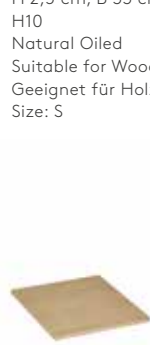

**67359**  
Natural Lacquered

**67362**  
White Lacquered



**SUKOYA 67354**

Shelf Unit | Regal Einlegeboden  
 Dimensions H 3,5 cm, B 50 cm, T 40 cm  
 Materials H10  
 Colour Natural Oiled  
 Features Suitable for Metal Shelf  
 Geeignet für Metallregal,  
 Size: M



**67354**  
Natural Lacquered

**67357**  
White Lacquered



**SUKOYA 67360**

Shelf Unit | Regal Einlegeboden  
 Dimensions H 2,5 cm, B 50 cm, T 40 cm  
 Materials H10  
 Colour Natural Oiled  
 Features Suitable for Wooden Shelf  
 Geeignet für Holzregal,  
 Size: M



**67360**  
Natural Lacquered

**67363**  
White Lacquered



**SUKOYA 67355**

Shelf Unit | Regal Einlegeboden  
 Dimensions H 3,5 cm, B 100 cm, T 40 cm  
 Materials H10  
 Colour Natural Oiled  
 Features Suitable for Metal Shelf  
 Geeignet für Metallregal,  
 Size: L



**67355**  
Natural Lacquered

**67358**  
White Lacquered



**SUKOYA 67361**

Shelf Unit | Regal Einlegeboden  
 Dimensions H 2,5 cm, B 100 cm, T 40 cm  
 Materials H10  
 Colour Natural Oiled  
 Features Suitable for Wooden Shelf  
 Geeignet für Holzregal,  
 Size: L



**67361**  
Natural Lacquered

**67364**  
White Lacquered





### SUKOYA

Two versions – for every style of living: SUKOYA is available in two versions. The wooden version has an oak frame and wooden boards made of oak veneer. The metal version is made of powder-coated steel with oak veneer shelves. The shelf units for both the wooden and metal versions are available in natural oiled and white oiled wood. Flexible design options: The shelf units are available in three different sizes and can be freely arranged in terms of size, combination, and positioning. This allows you to create a shelf that suits you perfectly. The shelf units are designed so that they can be moved freely on the fixed horizontal shelf frame. Easy assembly and demountable construction: SUKOYA is simple and easy to assemble – simply attach the horizontal and vertical parts together. The shelf units can then be added as required.

### SUKOYA

Zwei Ausführungen – für jeden Wohnstil: SUKOYA ist in zwei Versionen erhältlich. Die Holzversion ist aus einem Eichenrahmen und Holzbrettern aus Eichenfurnier gefertigt. Die Metallversion besteht aus pulverbeschichtetem Stahl mit Regalböden aus Eichenfurnier. Die Holz- und die Metallversion sind jeweils in natürlich geöltem und weiß geöltem Holz erhältlich. Flexible Gestaltungsmöglichkeiten: Die Regalbretter sind für beide Versionen in drei verschiedenen Größen erhältlich und können in der Größenkombination und der Positionierung frei angeordnet werden. So können Sie ein Regal schaffen, das genau zu Ihnen passt. Die Regalbretter sind so konzipiert, dass sie frei auf dem fest positionierten horizontalen Regalrahmen verschoben werden können. Leichte Montage und demontierbare Konstruktion: SUKOYA ist einfach und leicht zu montieren, indem die horizontalen und vertikalen Teile einfach miteinander befestigt werden. Anschließend können die Regalbretter beliebig hinzugefügt werden.

# Pallet delivery only. Nur Palettenversand.



#### TARJA RUG

The handcrafted nature of the TARJA rug makes it a truly special piece. Wool and viscose combine to create a warm, durable surface that radiates cosiness and serenity.

Simple, timeless and harmonious – TARJA brings quiet elegance to any room.

#### TARJA TEPPICH

Die Handarbeit macht den Teppich TARJA zu einem besonderen Stück. Wolle und Viskose verbinden sich zu einer warmen, strapazierfähigen Oberfläche, die Gemütlichkeit und Gelassenheit ausstrahlt.

Schlicht, zeitlos und harmonisch – TARJA bringt stille Eleganz in jeden Raum.



**TARJA 68378**

# Rug | Teppich  
 Dimensions B 140 cm, T 200 cm  
 Materials T6, T8  
 Colour Beige  
 Features Flor Height: ca. 2 cm  
 Florhöhe: ca. 2 cm, Size: S

NEW

**TARJA 68381**

# Rug | Teppich  
 Dimensions B 140 cm, T 200 cm  
 Materials T6, T8  
 Colour Taupe  
 Features Flor Height: ca. 2 cm  
 Florhöhe: ca. 2 cm, Size: S

NEW

**TARJA 68384**

# Rug | Teppich  
 Dimensions B 140 cm, T 200 cm  
 Materials T6, T8  
 Colour Zinc  
 Features Flor Height: ca. 2 cm  
 Florhöhe: ca. 2 cm, Size: S

NEW

**TARJA 68379**

# Rug | Teppich  
 Dimensions B 160 cm, T 240 cm  
 Materials T6, T8  
 Colour Beige  
 Features Flor Height: ca. 2 cm  
 Florhöhe: ca. 2 cm, Size: M

NEW

**TARJA 68382**

# Rug | Teppich  
 Dimensions B 160 cm, T 240 cm  
 Materials T6, T8  
 Colour Taupe  
 Features Flor Height: ca. 2 cm  
 Florhöhe: ca. 2 cm, Size: M

NEW

**TARJA 68400**

# Rug | Teppich  
 Dimensions B 160 cm, T 240 cm  
 Materials T6, T8  
 Colour Zinc  
 Features Flor Height: ca. 2 cm  
 Florhöhe: ca. 2 cm, Size: M

NEW

**TARJA 68402**

# Rug | Teppich  
 Dimensions B 200 cm, T 300 cm  
 Materials T6, T8  
 Colour Beige  
 Features Flor Height: ca. 2 cm  
 Florhöhe: ca. 2 cm, Size: L

NEW

**TARJA 68383**

# Rug | Teppich  
 Dimensions B 200 cm, T 300 cm  
 Materials T6, T8  
 Colour Taupe  
 Features Flor Height: ca. 2 cm  
 Florhöhe: ca. 2 cm, Size: L

NEW

**TARJA 68401**

# Rug | Teppich  
 Dimensions B 200 cm, T 300 cm  
 Materials T6, T8  
 Colour Zinc  
 Features Flor Height: ca. 2 cm  
 Florhöhe: ca. 2 cm, Size: L

NEW



# Pallet delivery only. Nur Palettenversand.



**UZU 67019**

# Rug | Teppich

Dimensions B 140 cm, T 200 cm

Materials T8

Colour Beige

Features Flor Height: ca 1,2 cm  
Florhöhe: ca 1,2 cm, Size: S

67019  
Beige



67022  
Taupe



67025  
Zinc



**UZU 67020**

# Rug | Teppich

Dimensions B 160 cm, T 240 cm

Materials T8

Colour Beige

Features Flor Height: ca 1,2 cm  
Florhöhe: ca 1,2 cm, Size: M

67020  
Beige



67023  
Taupe



67026  
Zinc



**UZU 67021**

# Rug | Teppich

Dimensions B 200 cm, T 300 cm

Materials T8

Colour Beige

Features Flor Height: ca 1,2 cm  
Florhöhe: ca 1,2 cm, Size: L

67021  
Beige



67024  
Taupe



67027  
Zinc



**UZU RUG**

The rug is made of viscose and its soft surface makes it ideal to furnish your living area or bedroom. Viscose combines the positive properties of cotton and silk and is not only soft and skin-friendly, but also hard-wearing. In addition, the material is OEKOTEX®-certified, which guarantees a sustainable production chain and responsible use of resources.

To get the most out of your rug for a long time, we recommend regular vacuuming or beating. Please do not use harsh cleaning agents as the fibres are very fine. Instead, remove coarse dirt with a damp cloth in the direction of the fibres.

**UZU TEPPICH**

Der Teppich besteht aus Viskose und eignet sich durch seine weiche Oberfläche ideal zur Einrichtung Ihres Wohnbereichs oder Schlafzimmers. Viskose vereint die positiven Eigenschaften von Baumwolle und Seide und ist nicht nur weich und hautfreundlich, sondern auch strapazierfähig. Zudem ist das Material OEKOTEX®-zertifiziert, was eine nachhaltige Produktionskette und einen verantwortungsbewussten Umgang mit Ressourcen garantiert.

Um lange etwas von Ihrem Teppich zu haben, empfehlen wir regelmäßiges Saugen oder Ausklopfen. Aufgrund seiner Faserfeinheit sollten Sie auf harte Reinigungsmittel verzichten und grobe Verschmutzungen stattdessen mit einem feuchten Tuch in Faserrichtung entfernen.







### UZU RUG

The Japanese designer Kazushige Miyake found inspiration for this rug series in the dry landscape gardens of Kyoto, the so-called "Karesansui". The patterns raked into the gravel there are reminiscent of the swirling currents of a river and are thus meant to symbolise the natural beauty and serenity of nature. However, this rug does not simply imitate the "Karesansui" style. The designer has rather tried to translate the essence of the gardens into a design that fits well into modern interiors. The combination of straight lines and circles expresses the randomness of nature and creates a relaxing atmosphere that adds harmony and a unique accent to quiet rooms.

### UZU TEPPICH

Inspiration für diese Teppichserie fand der japanische Designer Kazushige Miyake in den trockenen Landschaftsgärten Kyotos, den sogenannten „Karesansui“. Dort werden Muster in den Kies geharkt, die an die wirbelnden Strömungen eines Flusses erinnern und so die natürliche Schönheit und Gelassenheit der Natur symbolisieren sollen. Dieser Teppich imitiert aber nicht einfach den Karesansui-Stil, viel mehr hat der Designer versucht, die Essenz der Gärten in ein Design umzusetzen, das sich gut in moderne Innenräume einfügt. Die Kombination aus geraden Linien und Kreisen drückt dabei die Zufälligkeit der Natur aus und schafft eine entspannende Atmosphäre, die ruhigen Räumen Harmonie und einen einzigartigen Akzent verleiht.

# Pallet delivery only. Nur Palettenversand.



**VISCA 68375**

# Rug | Teppich  
 Dimensions B 140 cm, T 200 cm  
 Materials T8  
 Colour Dark Gray  
 Features Flor Height: ca. 1,2 cm  
 Florhöhe: ca.. 1,2 cm, Size: S

NEW



**VISCA 68376**

# Rug | Teppich  
 Dimensions B 160 cm, T 200 cm  
 Materials T8  
 Colour Dark Gray  
 Features Flor Height: ca. 1,2 cm  
 Florhöhe: ca.. 1,2 cm, Size: M

NEW



**VISCA 68377**

# Rug | Teppich  
 Dimensions B 200 cm, T 300 cm  
 Materials T8  
 Colour Dark Gray  
 Features Flor Height: ca. 1,2 cm  
 Florhöhe: ca.. 1,2 cm, Size: L

NEW



**VISCA RUG**

The flowing rug VISCA brings clearly structured lines into your home. At the same time, it provides for cosiness and elegance. The rug is made of viscose and its soft surface makes it ideal to furnish your living area or bedroom. Viscose combines the positive properties of cotton and silk and is not only soft and skin-friendly, but also hard-wearing. In addition, the material is OEKOTEX®-certified, which guarantees a sustainable production chain and responsible use of resources.

To get the most out of your rug for a long time, we recommend regular vacuuming or beating. Please do not use harsh cleaning agents as the fibres are very fine. Instead, remove coarse dirt with a damp cloth in the direction of the fibres.

**VISCA TEPPICH**

Der fließende Teppich VISCA bringt klare Linien in Ihr Zuhause. Gleichzeitig sorgt er für Gemütlichkeit und Eleganz. Der Teppich besteht aus Viskose und eignet sich durch seine weiche Oberfläche ideal zur Einrichtung Ihres Wohnbereichs oder Schlafzimmers. Viskose vereint die positiven Eigenschaften von Baumwolle und Seide und ist nicht nur weich und hautfreundlich, sondern auch strapazierfähig. Zudem ist das Material OEKOTEX®-zertifiziert, was eine nachhaltige Produktionskette und einen verantwortungsbewussten Umgang mit Ressourcen garantiert.

Um lange etwas von Ihrem Teppich zu haben, empfehlen wir regelmäßiges Saugen oder Ausklopfen. Aufgrund seiner Faserfeinheit sollten Sie auf harte Reinigungsmittel verzichten und grobe Verschmutzungen stattdessen mit einem feuchten Tuch in Faserrichtung entfernen.



**VISCA 67010**

# Rug | Teppich  
 Dimensions B 140 cm, T 200 cm  
 Materials T8  
 Colour Beige  
 Features Flor Height: ca 1,2 cm  
 Florhöhe: ca 1,2 cm, Size: S



67010  
Beige



67013  
Taupe



67016  
Zinc

**VISCA 67011**

# Rug | Teppich  
 Dimensions B 160 cm, T 240 cm  
 Materials T8  
 Colour Beige  
 Features Flor Height: ca 1,2 cm  
 Florhöhe: ca 1,2 cm, Size: M



67011  
Beige



67014  
Taupe



67017  
Zinc



# Pallet delivery only. Nur Palettenversand.

**VISCA 67012**

# Rug | Teppich  
 Dimensions B 200 cm, T 300 cm  
 Materials T8  
 Colour Beige  
 Features Flor Height: ca 1,2 cm  
 Florhöhe: ca 1,2 cm, Size: L



67012  
Beige



67015  
Taupe



67018  
Zinc



**VOLOS 67069**

# Side Table | Beistelltisch  
 Dimensions H 34 cm, B 52 cm, T 52 cm  
 Materials ST6  
 Colour Travertine



67069  
Travertine



67061  
Silver Travertine



**VOLOS 67070**

# Side Table | Beistelltisch  
 Dimensions H 34 cm, Ø 52 cm  
 Materials ST6  
 Colour Travertine



67070  
Travertine



67062  
Silver Travertine



**VOLOS TRAVERTINE TABLES – DESIGN BY SEBASTIAN HERKNER**

Travertine is a porous limestone. Characteristic for this natural stone are the holes and pores as well as colour differences. However, this is what makes this stone so pleasant to handle.

Please simply wipe the table with a damp cloth and avoid soaking it or bringing it into contact with acidic cleaning agents.

**VOLOS TRAVERTINTISCHE – DESIGN VON SEBASTIAN HERKNER**

Travertin ist ein poröser Kalkstein. Charakteristisch für diesen Naturstein sind die Löcher und Poren sowie farbliche Unterschiede. Jedoch gerade das macht diesen Stein so angenehm in der Handhabung.

Bitte wischen Sie den Tisch mit einem feuchten Tuch ab. Vermeiden Sie es, ihn einzuweichen. Bitte vermeiden Sie Kontakt mit sauren Reinigungsmitteln.



**VOLOS 67071**

# Coffee Table | Couchtisch  
 Dimensions H 26 cm, B 100 cm, T 70 cm  
 Materials ST6  
 Colour Travertine



**VOLOS 67072**

# Coffee Table | Couchtisch  
 Dimensions H 26 cm, Ø 75 cm  
 Materials ST6  
 Colour Travertine



**VARU 66943**

# Set of 2 Side Tables | Set 2 Beistelltische  
 Dimensions H 45 cm, B 45 cm, T 45 cm  
 H 40 cm, B 35 cm, T 35 cm  
 Materials ST6  
 Colour Travertine



**VARU 66944**

# Set of 2 Side Tables | Set 2 Beistelltische  
 Dimensions H 45 cm, B 45 cm, T 45 cm  
 H 40 cm, B 35 cm, T 35 cm  
 Materials ST5  
 Colour Tundra Gray



# Pallet delivery only. Nur Palettenversand.



**ORU 66697**

Side Table | Beistelltisch  
 Dimensions H 47 cm, Ø 35 cm  
 Materials Sb, K3  
 Colour Black  
 Features Size: S



**ORU 66930**

Side Table | Beistelltisch  
 Dimensions H 40 cm, Ø 50 cm  
 Materials Sb, K3  
 Colour Black  
 Features Size: M



**ORU 67198**

Side Table | Beistelltisch  
 Dimensions H 47 cm, Ø 35 cm  
 Materials SSm, K3  
 Colour Matt  
 Features Size: S



**ORU 67199**

Side Table | Beistelltisch  
 Dimensions H 40 cm, Ø 50 cm  
 Materials SSm, K3  
 Colour Matt  
 Features Size: S



**ORU LINE**

The traditional Japanese art form origami inspired the German designer Robin Scholtysik to develop the ORU line for blomus. What began with the design of a filigree and sculptural side table has evolved into a complete and functional furniture collection. The ORU side table is the centrepiece of the line. Based on the principles of origami, the table is made of thin metal sheets that form an three-dimensional sculptural shape when put together. The small but important details such as the laser-cut joints and the gently curved interfaces give the table its characteristic aesthetic. Two very different sizes can also be combined very well to form a larger surface.

**ORU SERIE**

Die traditionelle japanische Kunstform Origami inspirierte den deutschen Designer Robin Scholtysik bei der Entwicklung der ORU Serie für blomus. Was mit dem Entwurf eines filigranen und skulpturalen Beistelltisches begann, hat sich zu einer vollständigen und funktionalen Möbelkollektion weiterentwickelt. Der Beistelltisch ORU ist das Herzstück der Serie. Basierend auf den Prinzipien des Origami, ist der Tisch aus dünnen Metallblechen gefertigt, die zusammengesetzt eine dreidimensionale skulpturale Form bilden. Die kleinen, aber wichtigen Details wie die ausgelaserten Fugen und die sanft gebogenen Schnittstellen, verleihen dem Tisch seine charakteristische Ästhetik. Zwei sehr unterschiedliche Größen können auch sehr gut zu einer größeren Fläche kombiniert werden.



The QR code leads you to the ORU page.  
 Der QR-Code führt Sie zu der ORU Seite.



**ORU 67204**

Wall Shelf | Wandregal  
 Dimensions H 14 cm, B 30 cm, T 22 cm  
 Materials SSm, K3  
 Colour Matt

**ORU 67209**

Wall Shelf | Wandregal  
 Dimensions H 14 cm, B 30 cm, T 22 cm  
 Materials Sb, K3  
 Colour Burned Metal

**ORU 67205**

Wall Shelf | Wandregal  
 Dimensions H 14 cm, B 60 cm, T 22 cm  
 Materials SSm, K3  
 Colour Matt

**ORU 67210**

Wall Shelf | Wandregal  
 Dimensions H 14 cm, B 60 cm, T 22 cm  
 Materials Sb, K3  
 Colour Burned Metal

**ORU SHELVES**

The ORU wall shelving system offers versatile storage options and adapts perfectly to individual requirements. It is available in three different length configurations, which can be combined as desired to create unique and functional wall solutions. Made from the distinctive steel sheets of the ORU line, the shelves combine robustness and lightness. They are ideal as a single shelf next to the bed or sofa, as well as an extended shelf for storing books, displaying decorative items or as a practical solution in the kitchen. The versatile configuration options of the shelving system make it the highlight of the ORU line.

**ORU SHELVES**

Das Wandregalsystem ORU bietet vielseitige Aufbewahrungsmöglichkeiten und passt sich perfekt den individuellen Bedürfnissen an. Es ist in drei unterschiedlichen Längenkonfigurationen erhältlich, die sich nach Belieben kombinieren lassen, um einzigartige und funktionale Wandlösungen zu schaffen. Gefertigt aus den markanten Stahlblechen der ORU Serie, vereinen die Regale Robustheit und Leichtigkeit. Sie eignen sich ideal als einzelnes Regal neben dem Bett oder dem Sofa, sowie auch als verlängertes Regal zur Aufbewahrung von Büchern, zum Präsentieren von Dekorationsgegenständen oder als praktische Lösung in der Küche. Mit den vielseitigen Konfigurationsmöglichkeiten des Regalsystems ist es das Highlight der ORU Serie.

**ORU 67206**

Wall Shelf | Wandregal  
 Dimensions H 14 cm, B 80 cm, T 22 cm  
 Materials SSm, K3  
 Colour Matt

**ORU 67211**

Wall Shelf | Wandregal  
 Dimensions H 14 cm, B 80 cm, T 22 cm  
 Materials Sb, K3  
 Colour Burned Metal





**ORU 67202**

Bench | Sitzbank  
 Dimensions H 45 cm, B 80 cm, T 35 cm  
 Materials SSm, K3  
 Colour Matt



**ORU 67203**

Console Table | Sideboard  
 Dimensions H 75 cm, B 80 cm, T 35 cm  
 Materials SSm, K3  
 Colour Matt



**ORU 67207**

Bench | Sitzbank  
 Dimensions H 45 cm, B 80 cm, T 35 cm  
 Materials Sb, K3  
 Colour Burned Metal



**ORU 67208**

Console Table | Sideboard  
 Dimensions H 75 cm, B 80 cm, T 35 cm  
 Materials Sb, K3  
 Colour Burned Metal



**ORU BENCH**

The ORU bench combines modern design with outstanding comfort. Its base is made of the same thin steel as the coffee tables, creating a uniform look. Thanks to its clear, minimalist lines, the bench can be used in a variety of ways – whether in the entrance area, as additional seating in the living room or at the foot of a bed. The bench can be ideally combined with the round side tables to create an interesting and playful landscape in your rooms.

**ORU BANK**

Die Bank ORU vereint modernes Design mit hervorragendem Komfort. Ihr Untergestell besteht aus demselben dünnen Stahl wie die Couchtische, wodurch eine einheitliche Optik entsteht. Dank ihrer klaren, minimalistischen Linienführung ist die Bank vielseitig einsetzbar – ob im Eingangsbereich, als zusätzliche Sitzmöglichkeit im Wohnzimmer oder am Fußende eines Bettes. Die Bank lässt sich ideal mit den runden Beistell-tischen kombinieren und schafft so eine interessante und verspielte Landschaft in Ihren Räumen.



**ORU SIDEBOARD**

The ORU sideboard is an elegant piece of furniture that is characterised by its slim and raised shape. Ideal for displaying decorative objects or as a stylish shelf in the hallway or living room, it is a beautiful addition to the line. Made from the same sheet steel, it fits seamlessly into the design concept of the ORU line. Its simple elegance and functionality make it a universal piece of furniture that cuts a fine figure in any room.

**ORU SIDEBOARD**

Das Sideboard ORU ist ein elegantes Möbelstück, das sich durch seine schlanke und erhöhte Form auszeichnet. Ideal für die Präsentation von Dekorationsobjekten oder als stilvolle Ablage im Flur oder Wohnzimmer, ist es eine schöne Ergänzung der Serie. Gefertigt aus den gleichen Stahlblechen, fügt sich das Sideboard nahtlos in das Designkonzept der ORU Serie ein. Die schlichte Eleganz und Funktionalität machen es zu einem universellen Möbelstück, das in jedem Raum eine gute Figur macht.



**ORU 68373**

Seat Pad | Sitzkissen

Dimensions H 0,5 cm, B 79 cm, T 34 cm

Materials T4

Colour Stone Melange

Features Suitable for ORU Bench

Geeignet für ORU Sitzbank

**SEAT PADS**

Simple, timeless, minimalist – the ORU seat cushion is perfectly matched to the bench of the same name. The felt in the colour Stone Melange provides pleasant comfort and blends discreetly into various living concepts. The non-slip coating on the underside ensures the necessary grip. Felt is a natural material, so there may be slight variations in the dimensions of ORU seat cushion.

**SITZKISSEN**

Schlicht, zeitlos, minimalistisch – das Sitzkissen ORU ist perfekt auf die gleichnamige Sitzbank abgestimmt. Der Filz in der Farbe Stone Melange sorgt für angenehmen Komfort und fügt sich dezent in verschiedene Wohnkonzepte ein. Die Antirutschbeschichtung auf der Unterseite sorgt für den notwendigen Halt. Filz ist ein Naturmaterial, daher kann es bei dem ORU Sitzkissen zu leichten Maßabweichungen kommen.



# LIVING ESSENTIALS

## FERA 63234

# Set of 2 Side Tables | Set 2 Beistelltische  
 Dimensions H 40 cm, B 50 cm, T 40 cm  
 H 45 cm, B 60 cm, T 50 cm  
 Materials Sb  
 Colour White  
 Features Size: L

NEW



63234  
White



63233  
Mourning Dove



63231  
Steel Gray



63230  
Black



63232  
Nomad



## FERA 66198

# Set of 2 Side Tables | Set 2 Beistelltische  
 Dimensions H 35 cm, B 35 cm, T 35 cm  
 H 40 cm, B 40 cm, T 40 cm  
 Materials Sb  
 Colour White  
 Features: Size: M



66198  
White



65989  
Mourning Dove



65985  
Steel Gray



65750  
Black



65987  
Nomad



## FERA 66007

# Coffee Table | Couchtisch  
 Dimensions H 45 cm, B 90 cm, T 50 cm  
 Materials Sb  
 Colour Black



**FERA 63226**

# Pedestal | Podest  
 Dimensions H 80 cm, B 35 cm, T 35 cm  
 Materials Sb  
 Colour White



63226  
White



63224  
Mourning Dove



63223  
Steel Gray



63222  
Black



63225  
Nomad



**FERA 66200**

# Console Table | Sideboard  
 Dimensions H 80 cm, B 85 cm, T 35 cm  
 Materials Sb  
 Colour White



66200  
White



65990  
Mourning Dove



65986  
Steel Gray



65751  
Black



65988  
Nomad



**FERA 66199**

# Side Table | Beistelltisch  
 Dimensions H 58 cm, B 50 cm, T 25 cm  
 Materials Sb  
 Colour White



66199  
White



66013  
Mourning Dove



66014  
Steel Gray



66011  
Black



66012  
Nomad



# Pallet delivery only. Nur Palettenversand.

**TORU 67125**

Stool, Side Table | Hocker, Beistelltisch  
 Dimensions H 32 cm, Ø 40 cm  
 Materials ST2  
 Colour Lily White  
 Features Max. weight: 95 kg/200 lbs  
 Max. Gewicht: 95 kg



**67125**  
Lily White



**67124**  
Fungi



**67126**  
Elephant Skin



**TORU 67122**

Stool, Side Table | Hocker, Beistelltisch  
 Dimensions H 44 cm, Ø 33 cm  
 Materials ST2  
 Colour Lily White  
 Features Max. weight: 95 kg/200 lbs  
 Max. Gewicht: 95 kg



**67122**  
Lily White



**67121**  
Fungi



**67123**  
Elephant Skin



**TORU 67119**

Stool, Side Table | Hocker, Beistelltisch  
 Dimensions H 44 cm, Ø 34 cm  
 Materials ST2  
 Colour Lily White  
 Features Max. weight: 95 kg/200 lbs  
 Max. Gewicht: 95 kg



**67119**  
Lily White



**67118**  
Fungi



**67120**  
Elephant Skin



**TORU 68119**

Stool, Side Table | Hocker, Beistelltisch  
 Dimensions H 43 cm, Ø 32 cm  
 Materials ST2  
 Colour Lily White  
 Features Max. weight: 95 kg/200 lbs  
 Max. Gewicht: 95 kg



**68119**  
Lily White



**68120**  
Indian Tan



**TEDDY – COZY AND VERSATILE**

Upholstered in fluffy, soft and short curly fabric, TEDDY impresses with its cozy factor. Thanks to the subtle integrated handle, TEDDY can be easily moved and used as a pouf next to the sofa or as a seat under the wardrobe. The pouf is supplied with fitted felt glides and is OEKOTEX®-certified. Matching cushion covers complete the TEDDY range.

**TEDDY – KUSCHELIG UND VIELSEITIG**

Gepolstert mit flauschig weichem, kurz gelocktem Stoff überzeugt TEDDY durch seinen Kuschelfaktor. Dank der dezent integrierten Trageschleife kann TEDDY mühelos bewegt und sowohl als Hocker neben dem Sofa oder als Sitzmöglichkeit unter der Garderobe genutzt werden. Der Hocker wird mit montierten Filzgleitern geliefert und ist OEKOTEX®-zertifiziert. Passende Kissenhüllen ergänzen das TEDDY Sortiment.

**TOKI 68136**

Stool, Side Table | Hocker, Beistelltisch  
 Dimensions H 45 cm, B 38 cm, T 26 cm  
 Materials ST2  
 Colour Lily White  
 Features Max. weight: 95 kg/200 lbs  
 Max. Gewicht: 95 kg

NEW



**TOKI**

Minimalist in form, full of character in its surface: the TOKI ceramic stool by Kazushige Miyake is both a stool and a side table. Its striking texture and timeless colour make it an accent piece that fits flexibly into any room.

**TOKI**

Minimalistisch in der Form, charaktvoll in der Oberfläche: Der TOKI Keramikhocker von Kazushige Miyake ist Hocker und Beistelltisch zugleich. Seine markante Textur und zeitlose Farbe machen ihn zu einem Akzentobjekt, das sich flexibel in jeden Raum einfügt.



**TEDDY 68072**

Pouf | Hocker  
 Dimensions H 40 cm, Ø 35 cm  
 Materials T3  
 Colour Moonbeam  
 Features STANDARD 100 by OEKO-TEX®,  
 max. weight: 100 kg/200 lbs  
 Max. Gewicht: 100 kg



**68072**  
Moonbeam



**68069**  
Fungi



**68070**  
Espresso



**68071**  
Sharkskin



**SAHLA 68370**

Pedestal | Podest  
 Dimensions H 46 cm, B 35 cm, T 35 cm  
 Materials T10  
 Colour Nomad  
 Features Max. weight: approx. 10 kg/22 lbs  
 Max. Gewicht: ca. 10 kg

NEW



**SAHLA 68371**

Pedestal | Podest  
 Dimensions H 46 cm, B 35 cm, T 35 cm  
 Materials T10  
 Colour Indian Tan  
 Features Max. weight: approx. 10 kg/22 lbs  
 Max. Gewicht: ca. 10 kg

NEW



**SAHLA 68372**

Pedestal | Podest  
 Dimensions H 46 cm, B 35 cm, T 35 cm  
 Materials T10  
 Colour Pewter  
 Features Max. weight: approx. 10 kg/22 lbs  
 Max. Gewicht: ca. 10 kg

NEW



**SAHLA 68329**

Pedestal | Podest  
 Dimensions H 60 cm, B 35 cm, T 35 cm  
 Materials T10  
 Colour Nomad  
 Features Max. weight: approx. 10 kg/22 lbs  
 Max. Gewicht: ca. 10 kg

NEW



**SAHLA 68330**

Pedestal | Podest  
 Dimensions H 60 cm, B 35 cm, T 35 cm  
 Materials T10  
 Colour Indian Tan  
 Features Max. weight: approx. 10 kg/22 lbs  
 Max. Gewicht: ca. 10 kg

NEW



**SAHLA 68331**

Pedestal | Podest  
 Dimensions H 60 cm, B 35 cm, T 35 cm  
 Materials T10  
 Colour Pewter  
 Features Max. weight: approx. 10 kg/22 lbs  
 Max. Gewicht: ca. 10 kg

NEW



**SAHLA 68332**

Pedestal | Podest  
 Dimensions H 76 cm, B 35 cm, T 35 cm  
 Materials T10  
 Colour Nomad  
 Features Max. weight: approx. 10 kg/22 lbs  
 Max. Gewicht: ca. 10 kg

NEW



**SAHLA 68333**

Pedestal | Podest  
 Dimensions H 76 cm, B 35 cm, T 35 cm  
 Materials T10  
 Colour Indian Tan  
 Features Max. weight: approx. 10 kg/22 lbs  
 Max. Gewicht: ca. 10 kg

NEW



**SAHLA 68334**

Pedestal | Podest  
 Dimensions H 76 cm, B 35 cm, T 35 cm  
 Materials T10  
 Colour Pewter  
 Features Max. weight: approx. 10 kg/22 lbs  
 Max. Gewicht: ca. 10 kg

NEW





**SAHLA PEDESTAL**

The SAHLA pedestal is both a stage and an object. With its suede-look cover, it adds an elegant touch to any room – whether as part of an ensemble or on its own. Plants, vases, works of art: everything finds a worthy place here.

**SAHLA PODEST**

Das SAHLA Podest ist Bühne und Objekt zugleich. Mit Bezug in Wildlederoptik wird es zum eleganten Akzent im Raum – ob als Ensemble oder alleinstehend. Pflanzen, Vasen, Kunstwerke: jeder Gegenstand erhält hier einen würdigen Platz.



**ETA 68362**

Side Table | Beistelltisch  
 Dimensions H 58 cm, B 36 cm, T 46 cm  
 Materials H2  
 Colour Oak

NEW



**ETA 68363**

Side Table | Beistelltisch  
 Dimensions H 58 cm, B 36 cm, T 46 cm  
 Materials H2  
 Colour Black

NEW



**ETA – DESIGN BY ANTON BJÖRSING**

The ETA side table by Anton Björnsing is more than just practical – it is a versatile companion. Solid, FSC® certified oak, gentle curves and a distinctive carrying handle create stability and lightness at the same time. Its name plays on the letters of its shape – a design that is both functional and poetic.

**ETA – DESIGN VON ANTON BJÖRSING**

Der Beistelltisch ETA von Anton Björnsing ist mehr als praktisch – er ist ein flexibler Begleiter. Massives, FSC® zertifiziertes Eichenholz, sanfte Rundungen und ein markanter Tragegriff schaffen Stabilität und Leichtigkeit zugleich. Sein Name spielt mit den Buchstaben seiner Form – ein Design, das funktional und poetisch zugleich ist.

**ENGAWA 68343**

Side Table | Beistelltisch  
 Dimensions H 37 cm, B 45 cm, T 45 cm  
 Materials H2  
 Colour Oak  
 Features Size: S

68343  
Oak



68347  
Black

**ENGAWA 68344**

Side Table | Beistelltisch  
 Dimensions H 40 cm, B 50 cm, T 50 cm  
 Materials H2  
 Colour Oak  
 Features Size: M

68344  
Oak



68348  
Black

**ENGAWA 68345**

Stool | Hocker  
 Dimensions H 46 cm, B 35 cm, T 35 cm  
 Materials H2  
 Colour Oak

68345  
Oak



68349  
Black

**ENGAWA 68346**

Bench | Bank  
 Dimensions H 46 cm, B 90 cm, T 35 cm  
 Materials H2  
 Colour Oak

68346  
Oak



68350  
Black

**ENGAWA – DESIGN BY CARSTEN GOLLNICK**

The ENGAWA line by German designer Carsten Gollnick is a collection consisting of side tables, stools and a bench made of solid wood in white oiled or black stained oak. It is the creative interpretation and elegant refinement of a minimalist and asymmetrically arranged cross frame. The ENGAWA series is characterised by a very self-confident staging of the flat solid wood and the interlocking of the frame and table top. Fine handcrafted details, such as the transition from the bevelled table top to the table legs, emphasise the high quality craftsmanship of the series.

**ENGAWA – DESIGN VON CARSTEN GOLLNICK**

Die ENGAWA Linie vom deutschen Designer Carsten Gollnick ist eine Kollektion bestehend aus Beistelltischen, einem Hocker und einer Bank aus Massivholz in weiß geöltem oder schwarz gebeiztem Eichenholz. Sie ist die kreative Interpretation und elegante Verfeinerung eines minimalistischen und asymmetrisch angeordneten Kreuzgestells. Die ENGAWA Serie charakterisiert eine sehr selbstbewusste Inszenierung des flachen Massivholzes und der Verzahnung von Gestell und Tischplatte. Feine handwerkliche Details, wie der Übergang von der abgeschrägten Tischplatte zu den Tischbeinen, unterstreichen die hohe handwerkliche Qualität der Serie.





**AVIO – DESIGN BY KAZUSHIGE MIYAKE**

The name AVIO means married in Finnish and therefore fits this series very well, because two halves form a whole through a simple connection. The rounded shapes and the symmetrical form harmonise with a narrow gap and result in a simple but by no means boring furniture series, conceptualized by the Japanese designer Kazushige Miyake. The tables are made of FSC®-certified wood.

**AVIO – DESIGN VON KAZUSHIGE MIYAKE**

Der Name AVIO bedeutet „verheiratet“ auf Finnisch und passt deshalb so gut zu dieser Serie, weil zwei Hälften durch eine einfache Verbindung ein Ganzes ergeben. Die abgerundeten Formen und der symmetrische Aufbau harmonisieren mit einem schmalen Spalt und ergeben eine schlichte aber keinesfalls langweilige Möbelserie, entworfen von dem japanischen Designer Kazushige Miyake. Die Tische sind aus FSC®-zertifiziertem Holz gefertigt.

**AVIO 66691**

Stool | Hocker

Dimensions H 45 cm, B 38 cm, T 23 cm

Materials H2

Colour Oak

66691  
Oak



66694  
Black Oak



**AVIO 66692**

Side Table | Beistelltisch

Dimensions H 45 cm, B 55 cm, T 30 cm

Materials H2

Colour Oak

66692  
Oak



66695  
Black Oak



**AVIO 66693**

Sofa Table | Sofatisch

Dimensions H 38 cm, B 80 cm, T 43 cm

Materials H2

Colour Oak

66693  
Oak



66696  
Black Oak



**AVIO 67298**

# Coffee Table | Couchtisch

Dimensions H 31 cm, B 100 cm, T 54 cm

Materials H2

Colour Oak

67298  
Oak



67299  
Black



**GOBA 66936**

# Coffee Table | Couchtisch  
 Dimensions H 27 cm, B 80 cm, T 40 cm  
 Materials H2

**ELI 66512**

# Stool | Sitzhocker  
 Dimensions H 45 cm, B 38 cm, T 38 cm  
 Materials H2

**GOBA 66937**

# Coffee Table | Couchtisch  
 Dimensions H 26 cm, B 100 cm, T 71 cm  
 Materials H2

**ELI 66510**

# Bench | Sitzbank  
 Dimensions H 45 cm, B 110 cm, T 39,5 cm  
 Materials H2

**GOBA**

GOBA is a coffee table reduced to the essentials. It looks like a stable, unshakeable block, which nevertheless has a lightness due to the offset foot pedestal. This makes the table an eye-catcher in any room. The furniture is made of oak veneer.

**GOBA**

GOBA ist ein Couchtisch reduziert auf das Wesentliche. Er wirkt wie ein stabiler, unerschütterlicher Block, der durch das versetzte Fußpodest trotzdem eine Leichtigkeit aufweist. So wird der Tisch in jedem Raum zu einem Hingucker. Gefertigt ist das Möbel aus Eichenholz furnier.

**ELI**

Created by designer Theresa Rand, the ELI series is made in Europe from regional solid oak. The materiality is also reflected in its solid and bold appearance: the great thickness of the material gives the stool and the bench a visual and constructive strength. The rounded edges and shapes ensure that the wooden objects nevertheless have a sensual and soft appearance. The seating furniture is versatile and fits into the most diverse of environments.

**ELI**

Die von der Designerin Theresa Rand kreierte Serie ELI wird in Europa aus regionaler, massiver Eiche gefertigt. Die Materialität spiegelt sich auch in ihrer soliden und kühnen Erscheinung wieder: Die große Materialstärke verleiht dem Hocker und der Bank eine visuelle und konstruktive Stärke. Die abgerundeten Kanten und Formen sorgen dafür, dass die Holzobjekte trotzdem eine sinnliche und weiche Erscheinung haben. Die Sitzmöbel sind vielseitig einsetzbar und passen in die unterschiedlichsten Umgebungen.



# Pallet delivery only. Nur Palettenversand.

**TAITE 68335**

Table Lamp | Tischleuchte  
 Dimensions H 31 cm, Ø 36,5 cm  
 Materials Am, T3, Sm, K3  
 Colour Lily White  
 Features Without light source, with dimmer switch  
 Ohne Leuchtmittel, mit Dimmschalter



**68335**  
Lily White

**68336**  
Desert Sage

**68338**  
Cream Gold

**TAITE**

Indoor use only | Nur Indoorbenutzung

Fabric cable | Textilkabel

Protection class   Schutzklasse:	II
Input:	220-240 V ~ 50/60 Hz
Light source   Leuchtmittel:	E14, max. 25 W, dimmable LED
Cable length   Kabellänge:	220 cm
Plug type   Steckertyp:	Euro plug   Euro Stecker

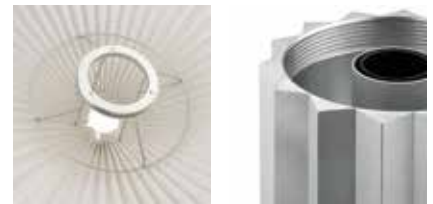

**A CLASSIC REIMAGINED – DESIGN BY THERESA RAND**

The TAITE table lamp reinterprets the classic pleated lamp. The contrasting materials of the textile shade, which is reminiscent of times gone by, and the modern aluminium base give the lamp a inspiring contemporary look. The sophisticated pleated look of the aluminium reflects the light source and creates an exciting interplay of light and shadow.

With her concept, designer Theresa Rand has managed to combine seemingly distant design elements to create something new. The lampshade is available in various colours and can be easily changed and replaced thanks to the rotating thread.

**EIN KLASSIKER NEU INTERPRETIERT – DESIGN VON THERESA RAND**

Die Tischleuchte TAITE interpretiert die klassische Plisseeleuchte neu. Durch die kontrastierenden Materialien des Textilschirms, der an vergangene Zeiten erinnert, und des modernen Aluminiumsockels bekommt die Lampe eine inspirierende Aktualität. Die raffinierte Plisseeoaptik des Aluminiums reflektiert die Lichtquelle und erzeugt ein spannendes Spiel aus Licht und Schatten.

Die Designerin Theresa Rand hat es mit ihrem Entwurf geschafft, vermeintlich weit entfernte Designelemente gezielt zu vereinen und daraus etwas Neues zu erschaffen. Der Lampenschirm ist in verschiedenen Farben erhältlich und kann dank des Drehgewindes spielend leicht gewechselt und ausgetauscht werden.



**IRIS 62214**

Table Lamp | Tischleuchte  
 Dimensions H 32 cm, Ø 24 cm  
 Materials Gf, Adm, K3, T3  
 Colour Lily White  
 Features 3 light colours, infinitely dimmable | 3 Lichtfarben, stufenlos dimmbar



**62214**  
Gun Metal, metallic finish

**62215**  
Metallic finish

**IRIS 62216**

Table Lamp | Tischleuchte  
 Dimensions H 32 cm, Ø 24 cm  
 Materials ST7, Adm, K3, T3  
 Colour Lily White  
 Features 3 light colours, infinitely dimmable | 3 Lichtfarben, stufenlos dimmbar



**62216**  
Gun Metal, metallic finish

**62217**  
Metallic finish

**IRIS**

Indoor use only | Nur Indoorbenutzung

LED light source | LED Leuchtmittel

Fabric cable | Textilkabel

Luminous flux   Lichtstrom:	115 lm Glass Shade, 580 lm Alabaster Shade
Output   Leistung:	9 W
Output light source   Leistung Leuchtmittel:	7.5 W
Voltage   Spannung:	DC 220-240 V, 50/ 60 Hz
Protection class   Schutzklasse:	II
Luminous colour   Lichtfarbe	2700-4000K
Cable length   Kabellänge:	150 cm

**IRIS GLASS – WHERE ELEGANCE MEETS INNOVATION**

Based on the very special design by Sebastian Herkner, there is now an indoor table lamp that continues the unusual design elements such as the large glass shade with enclosed air bubbles.

The design has been adapted from the small outdoor luminaire, but has grown in size many times over. The large luminaire head provides an even better view of the air bubbles, which are reminiscent of an underwater world. The light element shines from the inside and conjures up the magic of the deep sea in your home.

Unlike the small version, the on/off switch is protruding and has a knurled rotary knob. The diamond knurling gives this a tactile touch and breaks up the clean design of the aluminium base. The functions of the lights are the same, allowing you to dim the three light colours at will.

**IRIS GLAS – WO ELEGANZ AUF INNOVATION TRIFFT**

Aufbauend auf dem sehr besonderen Design von Sebastian Herkner gibt es nun eine Indoor-Tischleuchte, die die außergewöhnlichen Designelemente, wie den großen Glasschirm mit eingeschlossenen Luftbläschen, fortführt.

Die Konzeption ist an die kleine Outdoor-Leuchte angepasst, jedoch in der Größe um ein Vielfaches gewachsen. Der große Leuchtenkopf gibt noch mehr Blick auf die Luftbläschen, die an eine Unterwasserwelt erinnern. Das Leuchtelement strahlt von innen und zaubert die Magie der Tiefsee in Ihr Zuhause.

Der Ein-Aus-Schalter ist anders als bei der kleinen Variante herausstehend und mit einem gerändelten Drehknopf versehen. Dieser erhält durch die Diamanträndelung eine taktile Note und bricht das cleane Design der Aluminium Basis. Die Funktionen der Leuchten sind gleich, sodass Sie die drei Lichtfarben beliebig dimmen können.







### THE FREEDOM OF THE HOT AIR BALLOON

Our KAMI series consists of three lamps. The table lamp is available in a small size with a diameter of 32 cm and a bigger size with a diameter of 46 cm. Almost free-floating, the pendant lamp embodies the characteristics of the flying hot air balloon and provides cosy light from above. The hot air balloon shape is reminiscent of adventure and the boundless freedom of the sky and at the same time the certainty that home is the safe and stable base to which you can return at any time. Whether as a bedside lamp in the bedroom, a decorative highlight in the living room or a charming accessory in the children's room – this table lamp brings fantasy and elegance to any room. The ceiling light makes for an exciting eye-catcher and at the same time provides a sense of calm and cosiness. Experience the perfect combination of design and functionality and enjoy the mood created by the soft luminosity of our KAMI lamp. A little touch of wanderlust and freedom that will enchant your everyday life.

### DIE FREIHEIT DES HEISLUFTBALLONS

Unsere KAMI Serie besteht aus drei Leuchten. Die Tischleuchte ist in einer kleinen Größe mit einem Durchmesser von 32 cm und einer größeren Ausführung mit einem Durchmesser von 46 cm erhältlich. Nahezu freischwebend verkörpert die Hängeleuchte die Charakteristik des fliegenden Heißluftballons und spendet ein gemütliches Licht von oben. Die Heißluftballonform erinnert an Abenteuer und die grenzenlose Freiheit des Himmels und gleichzeitig die Sicherheit, dass das Zuhause die sichere und stabile Basis ist, zu der man jederzeit zurückkehren kann. Ob als Nachttischleuchte im Schlafzimmer, als dekoratives Highlight im Wohnzimmer oder als charmantes Accessoire im Kinderzimmer – diese Tischleuchte bringt Fantasie und Eleganz in jeden Raum. Die Deckenleuchte sorgt für einen spannenden Blickfang und verleiht gleichzeitig Ruhe und Geborgenheit. Erleben Sie die perfekte Kombination aus Design und Funktionalität und genießen Sie die Stimmung der sanften Leuchtkraft unserer KAMI Leuchte. Ein kleiner Hauch von Fernweh und Freiheit, der Ihren Alltag verzaubert.

**KAMI 68001**

Table Lamp | Tischleuchte  
 Dimensions H 31 cm, Ø 32 cm  
 Materials H11, H2, Sb, K3  
 Colour Oak  
 Features Without light source, with dimmer switch  
 Ohne Leuchtmittel, mit Dimmschalter, Size: S

**KAMI TABLE LAMP**

Indoor use only | Nur Indoorbenutzung

Fabric cable | Textilkabel

Protection class   Schutzklasse:	II
Input:	220-240 V ~ 50/60 Hz
Light source   Leuchtmittel 68001:	E14, max. 5 W, dimmable LED E14, max. 5 W, dimmbare LED
Light source   Leuchtmittel 68000:	E27, max. 11 W, dimmable LED E27, max. 11 W, dimmbare LED
Cable length   Kabellänge:	220 cm
Plug type   Steckertyp:	Euro plug   Euro Stecker

**KAMI 68000**

Table Lamp | Tischleuchte  
 Dimensions H 46 cm, Ø 46 cm  
 Materials H11, H2, Sb, K3  
 Colour Oak  
 Features Without light source, with dimmer switch  
 Ohne Leuchtmittel, mit Dimmschalter, Size: M

**KAMI - DESIGN BY KAZUSHIGE MIYAKE**

KAMI, Japanese for paper, bathes your home in a warm, soft light. This enchanting lamp combines Far Eastern craftsmanship with modern design and is a real eye-catcher for any room. The delicate lampshade made of fine rice paper emits a pleasant, diffuse light that creates a calming atmosphere and transforms any room into a cosy ambience. The base made of high-quality wood adds natural warmth to the light and provides a stable, stylish contrast to the airy design of the lampshade.

**KAMI - DESIGN VON KAZUSHIGE MIYAKE**

KAMI, japanisch für Papier, taucht Ihr Zuhause in ein warmes, sanftes Licht. Diese zauberhafte Leuchte vereint fernöstliche Handwerkskunst mit modernem Design und ist ein echter Blickfang für jeden Raum. Der zarte Lampenschirm aus feinem Reispapier verströmt ein angenehmes, diffuses Licht, das eine beruhigende Atmosphäre schafft und jeden Raum in ein gemütliches Ambiente verwandelt. Der Sockel aus hochwertigem Holz fügt der Leuchte natürliche Wärme hinzu und bietet einen stabilen, stilvollen Kontrast zum luftigen Design des Lampenschirms.



reddot winner 2025

**KAMI 68049**

Pendant Lamp | Hängeleuchte  
 Dimensions H 48 cm, Ø 60 cm  
 Materials H11, H2, Sb, K3  
 Colour Oak  
 Features Without light source | Ohne Leuchtmittel

**KAMI PENDANT LAMP**

Indoor use only | Nur Indoorbenutzung

Fabric cable | Textilkabel

Protection class   Schutzklasse:	II
Input:	220-240 V ~ 50/60 Hz
Light source   Leuchtmittel:	E27, max. 11 W, LED E27, max. 11 W, LED
Cable length   Kabellänge:	400 cm
Attachment   Befestigung:	Incl. ceiling canopy Inkl. Deckenbaldachin

**TEDDY 68090**

Cushion Cover | Kissenhülle  
 Dimensions B 30 cm, T 50 cm  
 Materials T3  
 Colour Moonbeam  
 Features STANDARD 100 by OEKO-TEX®



68090  
Moonbeam



68096  
Fungi



68099  
Espresso



68093  
Tan



68116  
Sharkskin



**TEDDY 68091**

Cushion Cover | Kissenhülle  
 Dimensions B 40 cm, T 60 cm  
 Materials T3  
 Colour Moonbeam  
 Features STANDARD 100 by OEKO-TEX®



68091  
Moonbeam



68097  
Fungi



68100  
Espresso



68094  
Tan



68117  
Sharkskin



**TEDDY 68092**

Cushion Cover | Kissenhülle  
 Dimensions B 50 cm, T 50 cm  
 Materials T3  
 Colour Moonbeam  
 Features STANDARD 100 by OEKO-TEX®



68092  
Moonbeam



68098  
Fungi



68115  
Espresso



68095  
Tan



68118  
Sharkskin





#### TEDDY CUSHION COVERS

The TEDDY cushion covers give your home a particularly warm and cosy atmosphere in a stylish way thanks to the fluffy soft, short curly texture. Available in three different sizes, the cushion covers come with a YKK zipper and are OEKOTEX®-certified. Machine washable at 30 degrees, we recommend washing the cushions with similar colours inside out with the zipper closed.

#### TEDDY KISSENHÜLLEN

Die TEDDY Kissenhüllen verleihen Ihrem Zuhause dank der flauschig weichen, kurz gelockten Textur auf stilvolle Weise eine besonders warme und kuschelige Atmosphäre. Die in drei unterschiedlichen Größen verfügbaren Kissenhüllen, verfügen über einen YKK Reißverschluss und sind OEKOTEX®-zertifiziert. Maschinenwaschbar bei 30 Grad, empfehlen wir die Kissen mit ähnlichen Farben auf links mit geschlossenem Reißverschluss zu waschen.



#### BOUCLE CUSHION COVER

The blomus BOUCLE collection has been extended by four stylish colours and offers you an impressive selection of twelve colours in four different sizes. BOUCLE is characterised by its unique knot, loop or knob structure, which is both visually appealing and easy to clean. Hardly creasing and machine washable, this OEKO-TEX®-certified quality is ideal for everyday use. Bring a breath of fresh air into your home with the BOUCLE collection!

#### CARE AND MATERIAL

The pillows are machine washable at 30 degrees. We recommend that dark colours are washed with similar colours. Please wash on the left side and close the zipper. 90% Polyester, 10% Acrylic; STANDARD 100 by OEKO-TEX®

#### BOUCLE CUSHION COVERS

Die blomus BOUCLE-Kollektion wird um vier stilvolle Farben erweitert und bietet Ihnen eine beeindruckende Auswahl von insgesamt zwölf Farben in vier verschiedenen Größen. Charakteristisch für BOUCLE ist die einzigartige Knoten-, Schlingen- oder Noppenstruktur, die sowohl durch ihre Optik als auch Pflegeleichtigkeit überzeugt. Kaum knitternd und maschinenwaschbar, eignet sich diese OEKO-TEX®-zertifizierte Qualität hervorragend für den täglichen Gebrauch. Bringen Sie mit der BOUCLE-Kollektion frischen Wind in Ihr Zuhause!

#### PFLEGE UND MATERIAL

Die Kissen sind maschinenwaschbar bei 30 Grad. Wir empfehlen, dass dunkle Farben mit ähnlichen Farben gewaschen werden. Bitte auf der linken Seite waschen und den Reißverschluss schließen. 90% Polyester, 10% Acryl; STANDARD 100 by OEKO-TEX®

**BOUCLE 66577**

Cushion Cover | Kissenhülle  
 Dimensions B 40 cm, T 40 cm  
 Materials T3  
 Colour Lily White  
 Features STANDARD 100 by OEKO-TEX®



66577  
Lily White

66578  
Moonbeam

67270  
Micro Chip

66582  
Midnight Blue

66580  
Magnet

66583  
Duck Green

67271  
Misty Rose

67272  
Nomad

66579  
Tan

66576  
Rustic Brown

66581  
Espresso

67273  
Mulch



**BOUCLE 66585**

Cushion Cover | Kissenhülle  
 Dimensions B 50 cm, T 50 cm  
 Materials T3  
 Colour Lily White  
 Features STANDARD 100 by OEKO-TEX®



66585  
Lily White

66586  
Moonbeam

67274  
Micro Chip

66590  
Midnight Blue

66588  
Magnet

66591  
Duck Green

67275  
Misty Rose

67276  
Nomad

66587  
Tan

66584  
Rustic Brown

66589  
Espresso

67277  
Mulch





**BOUCLE 66593**

Cushion Cover | Kissenhülle  
 Dimensions B 30 cm, T 50 cm  
 Materials T3  
 Colour Lily White  
 Features STANDARD 100 by OEKO-TEX®



		
66593 Lily White	66594 Moonbeam	67278 Micro Chip
		
66598 Midnight Blue	66596 Magnet	66599 Duck Green
		
67279 Misty Rose	67280 Nomad	66595 Tan
		
66592 Rustic Brown	66597 Espresso	67281 Mulch



**BOUCLE 66601**

Cushion Cover | Kissenhülle  
 Dimensions B 40 cm, T 60 cm  
 Materials T3  
 Colour Lily White  
 Features STANDARD 100 by OEKO-TEX®



		
66601 Lily White	66602 Moonbeam	67282 Micro Chip
		
66606 Midnight Blue	66604 Magnet	66607 Duck Green
		
67283 Misty Rose	67284 Nomad	66603 Tan
		
66600 Rustic Brown	66605 Espresso	67285 Mulch





**FILL 66646**

Cushion Filling | Kissenfüllung  
 Dimensions B 30 cm, T 50 cm  
 Materials T7  
 Features Recycled Feathers | Recycelte Federn  
 STANDARD 100 by OEKO-TEX®



**66646**  
B 30 cm, T 50 cm

**66647**  
B 40 cm, T 40 cm

**66648**  
B 50 cm, T 50 cm

**66649**  
B 40 cm, T 60 cm

**66650**  
B 45 cm, T 45 cm

**FILL 66641**

Cushion Filling | Kissenfüllung  
 Dimensions B 30 cm, T 50 cm  
 Materials T3  
 Features Polyester fiber | Polyesterwolle  
 STANDARD 100 by OEKO-TEX®



**66641**  
B 30 cm, T 50 cm

**66642**  
B 40 cm, T 40 cm

**66643**  
B 50 cm, T 50 cm

**66644**  
B 40 cm, T 60 cm

**66645**  
B 45 cm, T 45 cm

**FILL PILLOW FILLINGS – SOMETHING FOR EVERYONE**

The feather pillows are sustainably filled with cleaned and recycled feathers. They are well protected by the thick cotton cover. Airy classic with feathers or polyester wool as an alternative: we have the right size for every cushion cover. This way, the fillings can be added to the new cushion covers in an optimal and cosy way.

Both cushion fillings are certified by OEKO-TEX® STANDARD 100 and machine washable.

**FILL KISSENFÜLLUNGEN – FÜR JEDEN ETWAS DABEI**

Die Federkissen sind nachhaltig gefüllt mit gereinigten und recycelten Federn. Sie sind gut geschützt durch die dichte Baumwollhülle. Luftiger Klassiker mit Federn oder Polyesterwolle als Alternative: Für jede Kissenhülle haben wir die richtige Größe parat. So können die neuen Kissenhüllen optimal und gemütlich ergänzt werden.

Beide Kissenfüllungen sind zertifiziert durch OEKO-TEX® STANDARD 100 und maschinenwaschbar.

## LIVING ESSENTIALS

### FINHO – MERINO THROW

Discover FINHO – made in the Ukraine, this high-quality woollen blanket made from 100% merino wool is a luxurious home accessory that combines style and comfort. The elegant herringbone pattern with its harmonious two-tone colour scheme, combined with delicate fringing, gives the blanket a timeless charm.

### FINHO – MERINO DECKE

Entdecken Sie FINHO – hergestellt in der Ukraine, bietet diese hochwertige Wolldecke aus 100% Merinowolle ein luxuriöses Wohnaccessoire, welches Stil und Komfort vereint. Das elegante Fischgrätmuster mit seiner harmonischen Zweifarbigkeit, kombiniert mit zarten Fransen, verleiht der Decke einen zeitlosen Charme.



### FINHO 68004

Throw | Decke  
 Dimensions B 130 cm, T 200 cm  
 Materials T9  
 Colour Micro Chip  
 Features Mulesingfree Merino Wool  
 Mulesingfreie Merinowolle



68004  
Micro Chip



68002  
Indian Tan



68003  
Fungi



68005  
Dark Olive



### MERINO 66521

Throw | Decke  
 Dimensions B 130 cm, T 200 cm  
 Materials T6  
 Colour Micro Chip  
 Features 85% Merino Wool, 15% Cashmere  
 Mulesing free  
 85% Merinowolle, 15% Kaschmir,  
 mulesierungsfreie Merinowolle



66521  
Micro Chip



66522  
Sharkskin



66523  
Magnet



66524  
Moonbeam



66525  
Fungi



**AHWI 67116**

Throw | Decke

Dimensions B 145 cm, T 200 cm

Materials T6, T3

Colour Sharkskin

Features 70% recycled wool, 25% polyamide,  
5% other fibres  
70% recycelte Wolle, 25% Polyamid,  
5% andere Fasern



67116  
Sharkskin



67117  
Fungi



67115  
Agave Green



67114  
Midnight Navy

**AHWI**

Unobtrusive and yet unique. Handmade in Italy, AHWI throws are made from 70% wool production waste and carefully selected post-consumer recycled wool fibres. The design of AHWI is characterised by the two-tone colour of the throws, which creates a subtle melange effect. The deliberately contrasting choice of whip stitch emphasises AHWI's design.

Due to the use of post-consumer recycled wool, a small fibre content of 5% always remains, which cannot be precisely identified and is therefore labelled as other fibres.

**AHWI**

Unaufdringlich und dennoch einzigartig. Die in Italien handgefertigten AHWI-Decken bestehen zu 70% aus Produktionsabfällen der Wollproduktion, sowie sorgfältig ausgewählten Post-Verbraucher recycelten Wollfasern. Das Design von AHWI wird durch die Zweifarbigkeit der Decken geprägt, die einen dezenten Melangeeffekt erzeugt. Die bewusst kontrastierende Wahl des Whip Stitch hebt das Design von AHWI hervor.

Aufgrund der Verwendung von Post-Verbraucher recycelter Wolle bleibt stets ein geringer Faseranteil von 5%, der nicht präzise identifiziert werden kann und daher als andere Faser ausgewiesen wird.



**SAGA 66977**

Hurricane Lamp | Windlicht  
 Dimensions H 8,5 cm, Ø 8,3 cm  
 Materials Gf  
 Colour White  
 Features Coloured through, mouth blown glass  
 Durchgefärbtes, mundgeblasenes  
 Glas, Size: S



66977  
White



66975  
Tradewinds



66974  
Magnet



67127  
Vanilla



66976  
Mourning Dove



67130  
Espresso



**SAGA 66972**

Hurricane Lamp | Windlicht  
 Dimensions H 12 cm, Ø 12 cm  
 Materials Gf  
 Colour White  
 Features Coloured through, mouth blown glass  
 Durchgefärbtes, mundgeblasenes  
 Glas, Size: M



66972  
White



66970  
Tradewinds



66969  
Magnet



67128  
Vanilla



66971  
Mourning Dove



67131  
Espresso



**SAGA 66967**

Hurricane Lamp | Windlicht  
 Dimensions H 16 cm, Ø 15 cm  
 Materials Gf  
 Colour White  
 Features Coloured through, mouth blown glass  
 Durchgefärbtes, mundgeblasenes  
 Glas, Size: L



66967  
White



66965  
Tradewinds



66964  
Magnet



67129  
Vanilla



66966  
Mourning Dove



67132  
Espresso



**DOODLE 64890**

Candle Holder | Kerzenhalter  
 Dimensions H 8,5 cm, B 10 cm, T 9,5 cm  
 Materials SSm  
 Colour Matt  
 Features Suitable for Ø 22 mm candle  
 NEW Passend für Ø 22 mm Kerze

**DOODLE 64893**

Set of 2 Candle Holders | Set 2 Kerzenhalter  
 Dimensions H 8,5 cm, B 10 cm, T 9,5 cm  
 Materials ST8r  
 Colour Moonbeam  
 Features Suitable for Ø 22 mm candles  
 NEW Passend für Ø 22 mm Kerzen

**DOODLE – DESIGN BY DANIEL LAVONIUS JAREFELDT**

The modular DOODLE candle holders, designed by Daniel Lavonius Jarefeldt, are small sculptures for everyday use. Two intersecting arches form a graphic, playful element that can be combined in any way you like. Whether in stainless steel or coloured, recycled polyresin, DOODLE remains minimalist in form and emotional in effect.

**DOODLE – DESIGN VON DANIEL LAVONIUS JAREFELDT**

Die modularen DOODLE Kerzenhalter, entworfen von Daniel Lavonius Jarefeldt, sind kleine Skulpturen des Alltags. Zwei sich kreuzende Bögen bilden ein grafisches, spielerisches Element, das sich beliebig kombinieren lässt. Ob in Edelstahl oder aus farbigem, recycelten Polyresin – DOODLE bleibt minimalistisch in der Form und zugleich emotional in der Wirkung.



**VELA CANDLE HOLDERS**

Candlelight creates moments of coziness – the VELA candle holders enhance this effect. Matt glazed ceramic in soft or colourful tones has a warm and soft effect. The small version elegantly holds taper candles, while the large model with its generous plate surface allows for individual decorative arrangements.

**VELA KERZENHALTER**

Kerzenlicht schafft Momente der Geborgenheit – die VELA Kerzenhalter verstärken diese Wirkung. Matt glasierte Keramik in sanften oder farbenfrohen Tönen wirkt warm und weich. Die kleine Variante hebt Stabkerzen elegant an, während das große Modell mit großzügiger Tellerfläche ein individuelles Dekorationspiel ermöglicht.

**VELA 64847**

Candle Holder | Kerzenhalter  
 Dimensions H 9 cm, Ø 11 cm  
 Materials ST2  
 Colour Moonbeam  
 Features Suitable for Ø 22 mm candle  
 Passend für Ø 22 mm Kerze

**64847**  
Moonbeam



NEW

**64849**  
Satellite



**64848**  
Black



**VELA 64852**

Candle Holder | Kerzenhalter  
 Dimensions H 3,5 cm, Ø 16 cm  
 Materials ST2  
 Colour Moonbeam  
 Features Suitable for Ø 22 mm candle  
 Passend für Ø 22 mm Kerze

**64852**  
Moonbeam



NEW

**64854**  
Satellite



**64853**  
Black



**VELA 67147**

Candle Holder | Kerzenhalter  
 Dimensions H 4 cm, Ø 9 cm  
 Materials ST2  
 Colour Moonbeam  
 Features Suitable for Ø 22 mm candle  
 Passend für Ø 22 mm Kerze, Size: S



**67147**  
Moonbeam



**67146**  
Satellite



**67145**  
Black



**67148**  
Agave Green



**VELA 67140**

Candle Holder | Kerzenhalter  
 Dimensions H 3 cm, Ø 14,5 cm  
 Materials ST2  
 Colour Moonbeam  
 Features Suitable for Ø 22 mm candle  
 Passend für Ø 22 mm Kerze, Size: M



**67140**  
Moonbeam



**67139**  
Satellite



**67138**  
Black



**67141**  
Agave Green





**AVO 64667**

Vase | Vase

Dimensions H 9,5 cm, Ø 15 cm

Materials Gk

Features Suitable for sprouting an avocado pit  
Zum Keimen eines Avocadokerns  
geeignet, Size: S



**AVO 64668**

Vase | Vase

Dimensions H 14,5 cm, Ø 15,5 cm

Materials Gk

Features Suitable for sprouting an avocado pit  
Zum Keimen eines Avocadokerns  
geeignet, Size: M



**AVO VASE**

Nature you can touch. Bring a piece of nature into your home. Our handmade round glass vase offers your avocado seed a stylish home while it grows into a magnificent plant. The clear glass allows an unobstructed view of the germination process and will be an eye-catcher in any kitchen. Watch new life grow from a small seed and enjoy the beauty of nature.

**AVO VASE**

Natur zum Anfassen. Holen Sie sich ein Stück Natur in Ihre vier Wände. Unsere handgefertigte rundliche Glasvase bietet Ihrem Avocadokern ein stilvolles Zuhause während er zu einer prächtigen Pflanze heranwächst. Das klare Glas ermöglicht einen ungehinderten Blick auf den Keimprozess und wird zum Eyecatcher in jeder Küche. Beobachten Sie, wie aus einem kleinen Kern neues Leben entsteht und genießen Sie die Schönheit der Natur.



**DUASIS 64884**

Vase | Vase  
 Dimensions H 21 cm, B 18 cm, T 10 cm  
 Materials Gk  
 Features Size: S

NEW

**DUASIS 64887**

Vase | Vase  
 Dimensions H 28 cm, B 18 cm, T 10 cm  
 Materials Gk  
 Features Size: M

NEW

**DUASIS – DESIGN BY ILJA HUBER**

The DUASIS glass vases, designed by Ilja Huber, play with contrasts. From one angle, they appear clear and angular, while from another, they reveal soft, organic curves. Each vase is handmade and unique – an interplay of form, reflection and colour that subtly transforms rooms.

**DUASIS – DESIGN VON ILJA HUBER**

Die Glasvasen DUASIS, gestaltet von Ilja Huber, spielen mit Gegensätzen. Aus einem Blickwinkel wirken sie klar und kantig, aus einem anderen offenbaren sie weiche, organische Kurven. Jede Vase ist handgefertigt, jede ein Unikat – ein Zusammenspiel aus Form, Spiegelung und Farbe, das Räume subtil verwandelt.

**MIYABI 64741**

Vase | Vase  
 Dimensions H 21 cm, Ø 17 cm  
 Materials Gk

**MIYABI 64740**

Vase | Vase  
 Dimensions H 10 cm, Ø 23 cm  
 Materials Gk  
 Features With Flower Divider  
 Mit Steckgitter



**MIYABI 67042**

Vase | Vase  
 Dimensions H 10 cm, Ø 23 cm  
 Materials SSp  
 Colour Polished  
 Features With Flower Divider  
 Mit Steckgitter



**MIYABI 67079**

Vase | Vase  
 Dimensions H 10 cm, Ø 23 cm  
 Materials SSv  
 Colour Burned Metal, metallic finish  
 Features With Flower Divider  
 Mit Steckgitter



**MIYABI 66981**

Vase | Vase  
 Dimensions H 21 cm, Ø 17cm  
 Materials SSp  
 Colour Polished



**MIYABI 66982**

Vase | Vase  
 Dimensions H 21 cm, Ø 17cm  
 Materials SSv  
 Colour Burned Metal, metallic finish



**BACK TO THE ROOTS - STAINLESS STEEL**

Stainless steel has always been a popular material that can be used in a variety of ways. The shiny surface not only exudes a certain cleanliness, but its chemical properties are also particularly hygienic and robust. Therefore, this material is often used in kitchens or bathrooms. Stainless steel is also reconquering the living area for itself.

But not only stainless steel in its pure form, but also in Burned Metal suits any living area. The very dark brown captivates with its different nuances and looks either golden or shimmering black, depending on the light and the shape of the day. Which makes especially decorative items a very special eye-catcher.

**BACK TO THE ROOTS - EDELSTAHL**

Edelstahl ist schon lange ein beliebtes Material, das vielseitig einsetzbar ist. Die glänzende Oberfläche strahlt nicht nur eine gewisse Sauberkeit aus, sondern ist auch in seinen chemischen Eigenschaften besonders hygienisch und robust. Daher wird dieses Material gerne in Küchen oder Badezimmern eingesetzt. Edelstahl erobert allerdings auch den Wohnbereich für sich.

Aber nicht nur Edelstahl in seiner puren Form, sondern auch in Burned Metal passt sich jedem Wohnbereich an. Das sehr dunkle Braun besticht durch seine verschiedenen Nuancen und wirkt je nach Licht und Tagesform entweder golden oder schwarz schimmernd. Was gerade dekorative Artikel zu einem ganz besonderen Hingucker macht.

**MIYABI 66625**

Vase | Vase  
 Dimensions H 10 cm, Ø 23 cm  
 Materials ST2  
 Colour Moonbeam  
 Features With Flower Divider  
 Mit Steckgitter



66625  
Moonbeam



66626  
Nomad



66627  
Black



66628  
Agave Green



66629  
Terracotta

**MIYABI 66620**

Vase | Vase  
 Dimensions H 21 cm, Ø 17 cm  
 Materials ST2  
 Colour Moonbeam



66620  
Moonbeam



66621  
Nomad



66622  
Black



66623  
Agave Green



66624  
Terracotta

**A TASTE OF JAPAN WITH KAZUSHIGE MIYAKE**

The art of ikebana – the gentle and mindful arranging of flowers in sculptural bouquets – is an integral part of Japanese culture, and is therefore the obvious source of inspiration for the MIYABI vase, designed by Kazushige Miyake.

The vase is offered in two shapes, originating from the same visual concept – a lower version with an interlocking grid inside, which allows for the creation of artistic arrangements to suit a variety of tastes and occasions, and a taller version with a slightly simpler construction, intended for displaying flowers in a set bouquet or even a single, specially grown branch.

Replacement grid 88325 in black available separately.

**EINE KOSTPROBE JAPANS MIT KAZUSHIGE MIYAKE**

Die Kunst des Ikebana - das sanfte und achtsame Arrangieren von Blumen in skulpturalen Sträußen - ist ein integraler Bestandteil der japanischen Kultur und daher die offensichtliche Inspirationsquelle für die Vase MIYABI, entworfen von Kazushige Miyake.

Die Vase wird in zwei Formen angeboten, die auf demselben visuellen Konzept beruhen – eine niedrigere Version mit einem ineinander verschiebbaren Steckgitter im Inneren, die die Gestaltung kunstvoller Arrangements für verschiedene Geschmäcker und Anlässe ermöglicht, und eine höhere Version mit einer etwas einfacheren Konstruktion, die für die Präsentation eines Straußes oder auch eines einzelnen, besonders gewachsenen Astes geeignet ist.

Ersatzgitter 88325 in schwarz separat erhältlich.

**ONDEA 64616**

Bowl | Schale  
Dimensions H 5,5 cm, B 34 cm, T 28,5 cm  
Materials SSm  
Colour Matt  
Features Food safe  
Lebensmittelecht, Size: S



**ONDEA 64618**

Bowl | Schale  
Dimensions H 5,5 cm, B 34 cm, T 28,5 cm  
Materials SSp  
Colour Polished  
Features Food safe  
Lebensmittelecht, Size: S



**ONDEA 64617**

Bowl | Schale  
Dimensions H 7 cm, B 42 cm, T 35 cm  
Materials SSm  
Colour Matt  
Features Food safe  
Lebensmittelecht, Size: M



**ONDEA 64619**

Bowl | Schale  
Dimensions H 7 cm, B 42 cm, T 35 cm  
Materials SSp  
Colour Polished  
Features Food safe  
Lebensmittelecht, Size: M



**ONDEA 64479**

Bowl | Schale  
 Dimensions H 5,5 cm, B 34 cm, T 28,5 cm  
 Materials SSI  
 Colour Burned Metal, metallic finish  
 Features Food safe  
 Lebensmittelecht, Size: S

**ONDEA 64480**

Bowl | Schale  
 Dimensions H 7 cm, B 42 cm, T 35 cm  
 Materials SSI  
 Colour Burned Metal, metallic finish  
 Features Food safe  
 Lebensmittelecht, Size M

**ONDEA 64481**

Bowl | Schale  
 Dimensions H 10,5 cm, B 24,5 cm, T 23,5 cm  
 Materials SSI  
 Colour Burned Metal, metallic finish  
 Features Food safe  
 Lebensmittelecht, Size: S

**ONDEA 64482**

Bowl | Schale  
 Dimensions H 14,5 cm, Ø 30 cm  
 Materials SSI  
 Colour Burned Metal, metallic finish  
 Features Food safe  
 Lebensmittelecht, Size: S

**ONDEA STAINLESS STEEL**

Discover the versatile facets of our ONDEA bowl. The impressively simple bowls with a beautifully curved silhouette are available in burnt metal and a stainless steel version and can be used in a variety of ways – as an elegant decoration, practical fruit bowl or stylish storage place. The high-quality stainless steel, which has been with us since time immemorial, adds a special touch to any room and enhances your interior in a special way.

**ONDEA EDELSTAHL**

Entdecken Sie die vielseitigen Facetten unserer ONDEA Schale. Die eindrucksvoll schlichten Schalen mit schön geschwungener Silhouette sind in burned metal und einer Edelstahlvariante erhältlich und in vielseitiger Weise nutzbar – als elegante Dekoration, praktische Fruchtschale oder stilvoller Aufbewahrungsort. Der hochwertige Edelstahl, welcher uns seit jeher begleitet, verleiht jedem Raum einen besonderen Touch und wertet Ihre Einrichtung auf besondere Weise auf.

**LETA 64861**

Vase | Vase  
 Dimensions H 13 cm, Ø 13 cm  
 Materials ST2  
 Colour Moonbeam  
 Features Size: M

NEW



**LETA 64862**

Vase | Vase  
 Dimensions H 13 cm, Ø 13 cm  
 Materials ST2  
 Colour Mourning Dove  
 Features Size: M

NEW



**LETA 64860**

Vase | Vase  
 Dimensions H 13 cm, Ø 13 cm  
 Materials ST2  
 Colour Peat  
 Features Size: M

NEW



**LETA 64864**

Vase | Vase  
 Dimensions H 15 cm, Ø 15 cm  
 Materials ST2  
 Colour Moonbeam  
 Features Size: L

NEW



**LETA 64865**

Vase | Vase  
 Dimensions H 15 cm, Ø 15 cm  
 Materials ST2  
 Colour Mourning Dove  
 Features Size: L

NEW



**LETA 64863**

Vase | Vase  
 Dimensions H 15 cm, Ø 15 cm  
 Materials ST2  
 Colour Peat  
 Features Size: L

NEW



**LETA VASES**

LETA vases are a simple invitation to elegance. Their organic shape is unobtrusive, while the glossy surface captures the light and exudes a subtle sheen. Whether in neutral tones or sunny shades of yellow, LETA brings harmony to any setting.

**LETA VASES**

Die LETA Vasen sind eine schlichte Einladung zu Eleganz. Ihre organische Form wirkt unaufdringlich, während die glänzende Oberfläche das Licht einfängt und einen subtilen Glanz verstrahlt. Ob in neutralen Tönen oder in sonnigen Gelbabstufungen – LETA bringt Harmonie in jedes Ambiente.





**MAKOTO 64940**

# Vase | Vase  
 Dimensions H 9 cm, Ø 11 cm  
 Materials ST2  
 Colour Moonbeam  
 Features Size: S

NEW



64940  
Moonbeam



64941  
Elephant Skin

**MAKOTO 64942**

# Vase | Vase  
 Dimensions H 10,5 cm, Ø 13,5 cm  
 Materials ST2  
 Colour Moonbeam  
 Features Size: M

NEW



64942  
Moonbeam



64943  
Elephant Skin

**MAKOTO 64944**

# Vase | Vase  
 Dimensions H 13,5 cm, Ø 18 cm  
 Materials ST2  
 Colour Moonbeam  
 Features Size: L

NEW



64944  
Moonbeam



64945  
Elephant Skin

**MAKOTO VASES**

The MAKOTO collection by Carsten Gollnick stands for sincerity and simplicity. Clear geometries and soft, nature-inspired surfaces meet matt glazes that exude calm and clarity. Each piece is unique, with small variations giving it its character. Subtle bases lend plates, bowls and vases a floating lightness – for a table culture that combines minimalism and enjoyment.

**MAKOTO VASEN**

Die Kollektion MAKOTO von Carsten Gollnick steht für Aufrichtigkeit und Schlichtheit. Klare Geometrien und sanfte, naturinspirierte Oberflächen treffen auf matte Glasuren, die Ruhe und Klarheit verströmen. Jedes Stück ist ein Unikat, kleine Abweichungen machen seinen Charakter aus. Dezent Standfüße verleihen Tellern, Schalen und Vasen eine schwebende Leichtigkeit – für eine Tischkultur, die Minimalismus und Genuss verbindet.

# Pallet delivery only. Nur Palettenversand.



**COLORA 64834**

Vase | Vase  
 Dimensions H 15 cm, Ø 10,5 cm  
 Materials ST2  
 Colour Moonbeam  
 Features Matt, Size: S

NEW



**64834**  
Moonbeam



**64835**  
Mourning Dove



**64833**  
Peat

**COLORA VASES**

The COLORA vase series opens up new possibilities for interior design. Whether matt with a powdery restraint or glossy with interesting reflective properties, each surface has its own character. Strong blue tones lend freshness, while muted colours convey calm and consistency. Arranged in different sizes, COLORA becomes a stage for expressive floral arrangements. In addition to the classic muted colours that make the flowers shine even more brightly, COLORA vases are also available in bold colour variations from the Capsule Collection, bringing freshness into your home.

**COLORA VASES**

Mit der COLORA Vasenserie entstehen neue Möglichkeiten, Räume zu gestalten. Ob matt mit pudriger Zurückhaltung oder glänzend mit interessant spiegelnder Reflektion – jede Oberfläche hat ihren eigenen Charakter. Kräftige Blautöne verleihen Frische, gedeckte Farben Ruhe und Beständigkeit. In verschiedenen Größen arrangiert, wird COLORA zur Bühne für ausdrucksstarke Blumenarrangements. Neben den klassisch gedeckten Farben, die die Blumen noch mehr strahlen lassen, gibt es die COLORA Vasen auch in mutigen Farbvarianten der Capsule Collection, die Frische in Ihr Zuhause bringen.

**COLORA 64837**

Vase | Vase  
 Dimensions H 20 cm, Ø 14 cm  
 Materials ST2  
 Colour Moonbeam  
 Features Shiny  
 Glänzend, Size: L

NEW



**64837**  
Moonbeam



**64838**  
Mourning Dove



**64836**  
Peat

**HARI 68357**

Flower Frog | Steckigel  
 Dimensions H 2 cm, Ø 5 cm  
 Materials S2, S3, K4

NEW



**HARI 68358**

Flower Frog | Steckigel  
 Dimensions H 2 cm, Ø 8 cm  
 Materials S2, S3, K4

NEW



**HARI 68359**

Flower Frog | Steckigel  
 Dimensions H 2 cm, B 7 cm, T 9,5 cm  
 Materials S2, S3, K4

NEW



**COLORA 64840**

Vase | Vase  
 Dimensions H 15 cm, Ø 10,5 cm  
 Materials ST2  
 Colour Moonbeam  
 Features Shiny  
 Glänzend, Size: S

NEW



**64840**  
Moonbeam



**64841**  
Mourning Dove



**64839**  
Peat



**COLORA 64843**

Vase | Vase  
 Dimensions H 20 cm, Ø 14 cm  
 Materials ST2  
 Colour Moonbeam  
 Features Shiny  
 Glänzend, Size: L

NEW



**64843**  
Moonbeam



**64844**  
Mourning Dove



**64842**  
Peat



**COLORA 65906**

Vase | Vase  
 Dimensions H 15 cm, Ø 10,5 cm  
 Materials ST2  
 Colour Moonbeam  
 Features Soft touch, Size: S



**65906**  
Moonbeam



**66207**  
Mourning Dove



**66206**  
Steel Gray



**65902**  
Peat



**65905**  
Agave Green



**COLORA 65705**

Vase | Vase  
 Dimensions H 20 cm, Ø 14 cm  
 Materials ST2  
 Colour Moonbeam  
 Features Soft touch, Size: L



**65705**  
Moonbeam



**66209**  
Mourning Dove



**66208**  
Steel Gray



**65701**  
Peat



**65704**  
Agave Green



**CEOLA 66167**

Vase | Vase  
 Dimensions 18 cm, Ø 8 cm  
 Materials ST2  
 Colour White

66167  
White



66242  
Satellite



**CEOLA 66168**

Vase | Vase  
 Dimensions 25 cm, Ø 13 cm  
 Materials ST2  
 Colour White

66168  
White



66243  
Satellite



**CEOLA 66169**

Vase | Vase  
 Dimensions 19 cm, Ø 14 cm  
 Materials ST2  
 Colour White

66169  
White



66244  
Satellite



**CEOLA 66170**

Vase | Vase  
 Dimensions 13 cm, Ø 8 cm  
 Materials ST2  
 Colour White

66170  
White



66245  
Satellite



**CEOLA 66171**

Vase | Vase  
 Dimensions 21 cm, Ø 11 cm  
 Materials ST2  
 Colour White

66171  
White



66246  
Satellite





**NONA 66514**

Set of 3 Vases | Set 3 Vasen  
 Dimensions H 9 cm, H 7 cm, H 6,5 cm  
 Materials ST1  
 Colour 3 x White



**66514**  
3 x White



**66224**  
3 x Micro Chip



**66223**  
3 x Pewter



**65973**  
1 x Pewter, 1 x Micro Chip, 1 x Bark



**NONA 66516**

Herb Pot | Kräutertopf  
 Dimensions H 12,5 cm, Ø 15 cm  
 Materials ST1  
 Colour White



**66516**  
White



**65975**  
Micro Chip



**65974**  
Pewter



**DROP 65963**

Vase | Vase  
 Dimensions H 16,5 cm, Ø 12,5 cm  
 Materials Gf  
 Colour Smoke



**DROP 65965**

Vase | Vase  
 Dimensions H 24 cm, Ø 19 cm  
 Materials Gf  
 Colour Smoke



**DROP -**

**DESIGN BY JUSTYNA POPLAWSKA**

blomus glass products are not machine made but manufactured by experienced glassblowers. Tolerances in dimensions and the typical blisters in the glass make every object a unique product.

**DROP -**

**DESIGN VON JUSTYNA POPLAWSKA**

Die blomus Glasprodukte werden von erfahrenen Glasbläsern in Handarbeit gefertigt und nicht maschinell hergestellt. So machen die kleinen Maßtoleranzen in der Form und die für einen Glaskörper typischen Bläschen das Glasobjekt zu einem Unikat.

**MOON 65445**

# Decoration Bowl | Dekoschale  
 Dimensions H 7 cm, Ø 40 cm  
 Materials ST3  
 Features For indoor use only  
 Nur für Innenräume geeignet



**MOON 65446**

# Decoration Bowl | Dekoschale  
 Dimensions H 8,5 cm, Ø 50 cm  
 Materials ST3  
 Features For indoor use only  
 Nur für Innenräume geeignet



# Pallet delivery only. Nur Palettenversand.

**ABENTO 6662**

Marble Tray | Marmor Tablett  
 Dimensions H 7,5 cm, B 30 cm, T 18 cm  
 Materials ST5  
 Colour Nimbus Cloud  
 Features Terrazzo marble, with silicone feet to protect surfaces  
 Terrazzo Marmor, mit Silikonfüßen zum Schutz der Oberflächen



**6662**  
Nimbus Cloud



**6663**  
Sharkskin

**ABENTO MARBLE**

The ABENTO tray made of high-quality marble by designer AD Miller. The proportions have been adapted to the stone material without changing the slim design, so that this tray fits perfectly into an elegant decoration and still remains an eye-catcher.

Care instructions: Please wipe the tray with a damp cloth. Do not soak it and please avoid contact with greasy food and acidic cleaning agents.

**ABENTO MARMOR**

Das ABENTO Tablett aus hochwertigem Marmor vom Designer AD Miller. Die Proportionen wurden an das steinerne Material angepasst ohne das schlanke Design zu verändern, sodass sich dieses Tablett hervorragend in eine elegante Dekoration einfügt und trotzdem ein Hingucker bleibt.

Pflegehinweis: Bitte wischen Sie das Tablett mit einem feuchten Tuch ab. Weichen Sie es nicht ein und bitte vermeiden Sie Kontakt mit fettigen Lebensmitteln sowie sauren Reinigungsmitteln.

**VEN 66248**

Hurricane Lamp | Windlicht  
 Dimensions H 12 cm, Ø 9,5 cm  
 Materials Gf  
 Colour Smoke  
 Features Coloured through mouth blown glass | Durchgefärbtes, mundgeblasenes Glas - Size: S

**66248**  
Smoke



**66251**  
Coffee

**VEN 66249**

Hurricane Lamp | Windlicht  
 Dimensions H 15,5 cm, Ø 14 cm  
 Materials Gf  
 Colour Smoke  
 Features Coloured through mouth blown glass | Durchgefärbtes, mundgeblasenes Glas - Size: M

**66249**  
Smoke



**66252**  
Coffee

**VEN HURRICANE LAMP**

This mouthblown, coloured-through glass object is not machine made but manufactured by experienced glassblowers. Tolerances in dimensions and the typical blisters in the glass make every object a unique product.

**VEN WINDLICHT**

Dieses mundgeblasene, durchgefärbte Glasobjekt wird von erfahrenen Glasbläsern in Handarbeit gefertigt und nicht maschinell hergestellt. So machen die kleinen Maßtoleranzen in der Form und die für einen Glaskörper typischen Bläschen das Glasobjekt zu einem Unikat.

**VEN 66250**

Hurricane Lamp | Windlicht  
 Dimensions H 20 cm, Ø 17,5 cm  
 Materials Gf  
 Colour Smoke  
 Features Coloured through mouth blown glass | Durchgefärbtes, mundgeblasenes Glas - Size: L

**66250**  
Smoke



**66253**  
Coffee





**LYVA 62229**

Lantern | Laterne  
 Dimensions H 17 cm, Ø 25 cm  
 Materials Sb, Gk  
 Colour White  
 Features Glass included  
 Inklusive Glas, Size S



62229  
White



62231  
Steel Gray



62228  
Black



62230  
Mourning Dove



68027  
Nomad

**LYVA 62233**

Lantern | Laterne  
 Dimensions H 26,5 cm, Ø 31 cm  
 Materials Sb, Gk  
 Colour White  
 Features Glass included  
 Inklusive Glas, Size: M



62233  
White



62235  
Steel Gray



62232  
Black



62234  
Mourning Dove



68028  
Nomad

**LYVA 62237**

Lantern | Laterne  
 Dimensions H 45 cm, Ø 34 cm  
 Materials Sb, Gk  
 Colour White  
 Features Glass included  
 Inklusive Glas, Size: L



62237  
White



62239  
Steel Gray



62236  
Black



62238  
Mourning Dove



68029  
Nomad



#### LYVA – DESIGN BY NINA THÖMING

Under the name LYVA, blomus presents a new series of indoor lanterns designed by Nina Thöming. The LYVA design, with its slender, filigree metal struts, is a new interpretation of the proven design of the LITO lanterns. LYVA has a different shape and comes with a glass cylinder. The name is derived from the Finnish term 'Lydhyn valo', which means 'lantern light'. The perfect description for the new series: the metal struts ensure that the flickering light creates beautiful lighting effects. This creates an inviting and cosy atmosphere in your rooms.

#### LYVA – DESIGN VON NINA THÖMING

Unter dem Namen LYVA präsentiert blomus eine neue Serie von Indoorlaternen, entworfen von Nina Thöming. Das LYVA-Design, mit den schmalen, filigranen Metallstreben, ist eine neue Interpretation des bewährten Designs der LITO Laternen. LYVA hat eine andere Form und wird inklusive Glaszylinder geliefert. Der Name leitet sich vom finnischen Begriff „Lydhyn valo“ ab, was „Laternenlicht“ bedeutet. Die perfekte Beschreibung für die neue Serie: Die Metallstreben sorgen dafür, dass das flackernde Licht wunderschöne Lichteffekte verschafft. So entsteht eine einladende und gemütliche Atmosphäre in Ihren Räumen.

**LITO LANTERN**

Beautiful appearance: the LITO lantern not only creates wonderful lighting effects, but also a cosy atmosphere. The narrow, powder-coated steel struts convey a stylish lightness, combined with a rustic touch.

**LITO LATERNE**

Schöner Schein: Die Laterne LITO versprüht nicht nur wunderschöne Lichteffekte, sondern auch eine stimmungsvolle Atmosphäre. Die schmalen pulverbeschichteten Stahlstreben vermitteln eine stilvolle Leichtigkeit, gepaart mit einem rustikalen Touch.



The QR code leads you to the LITO page.  
Der QR-Code führt Sie zur LITO Seite.

**LITO 66214**

Lantern | Laterne  
 Dimensions H 10 cm, Ø 13,5 cm  
 Materials Sb  
 Colour White  
 Features For indoor use only  
 Nur für Innenräume geeignet, Size: XS



66214  
White



66213  
Steel Gray



66210  
Black



66212  
Mourning Dove



66211  
Nomad

**LITO 66203**

Lantern | Laterne  
 Dimensions H 17 cm, B 20,5 cm, T 20,5 cm  
 Materials Sb  
 Colour White  
 Features For indoor use only  
 Nur für Innenräume geeignet, Size: S



66203  
White



66147  
Steel Gray



65931  
Black



66146  
Mourning Dove



66145  
Nomad



**LITO 66204**

Lantern | Laterne  
 Dimensions H 27 cm, B 27,5 cm, T 27,5 cm  
 Materials Sb  
 Colour White  
 Features For indoor use only  
 Nur für Innenräume geeignet, Size: M



66204  
White



66150  
Steel Gray



65932  
Black



66149  
Mourning Dove



66148  
Nomad



**LITO 66205**

Lantern | Laterne  
 Dimensions H 45 cm, B 33 cm, T 33 cm  
 Materials Sb  
 Colour White  
 Features For indoor use only  
 Nur für Innenräume geeignet, Size: L



66205  
White



66153  
Steel Gray



65933  
Black



66152  
Mourning Dove



66151  
Nomad



**BAKI 64710**

Tray | Tablett  
 Dimensions H 1,5 cm, B 23 cm, T 10 cm  
 Materials H6  
 Colour Oak  
 Features With anti-slip surface  
 Mit rutschhemmender  
 Oberfläche, Size: S

64710  
Oak



64713  
Black



**BAKI 64711**

Tray | Tablett  
 Dimensions H 1,5 cm, B 36 cm, T 14,5 cm  
 Materials H6  
 Colour Oak  
 Features With anti-slip surface  
 Mit rutschhemmender  
 Oberfläche, Size: M

64711  
Oak



64714  
Black



**BAKI 64712**

Tray | Tablett  
 Dimensions H 1,5 cm, B 55 cm, T 20 cm  
 Materials H6  
 Colour Oak  
 Features With anti-slip surface  
 Mit rutschhemmender  
 Oberfläche, Size: L

64712  
Oak



64715  
Black



**BAKI TRAYS**

Organic shapes bring calm and yet life into a home. The BAKI trays made of FSC®-certified plywood reflect exactly this tranquility and can be combined in different sizes. The anti-slip surface prevents the items placed on it from falling over. Both colours, the neutral wood tone and the black, look simple and natural in any room.

As these items are food safe, they can also be used for presenting food.

**BAKI TABLETTS**

Organische Formen bringen Ruhe und dennoch Leben in ein Zuhause. Die BAKI Tablett aus FSC®-zertifiziertem Sperrholz spiegeln genau diese Ruhe wieder und können in verschiedenen Größen kombiniert werden. Die Anti-Rutsch Oberfläche bewahrt die darauf angerichteten Artikel vor dem Umfallen. Beide Farben, der neutrale Holz-Ton und das Schwarz, können schlicht und natürlich in jedem Raum angerichtet werden.

Durch die LFGB Zertifizierung sind die Tablett auch für Lebensmittel geeignet.



**OKU 64529**

Tray | Serviertablett  
 Dimensions H 2 cm, B 25 cm, T 12,5 cm  
 Materials H2  
 Colour Oak  
 Features Size: S

64529  
Oak



64532  
Black

**OKU 64530**

Tray | Serviertablett  
 Dimensions H 2 cm, B 27,5 cm, T 20 cm  
 Materials H2  
 Colour Oak  
 Features Size: M

64530  
Oak



64533  
Black

**OKU 64531**

Tray | Serviertablett  
 Dimensions H 2 cm, B 40 cm, T 30 cm  
 Materials H2  
 Colour Oak  
 Features Size: L

64531  
Oak



64534  
Black

**OKU 64547**

Tray | Serviertablett  
 Dimensions H 2 cm, Ø 25 cm  
 Materials H2  
 Colour Oak  
 Features Size: S

64547  
Oak



64549  
Black

**OKU TRAY**

Make serving a meal a highlight and let your creativity flow when it comes to table decoration. The versatile OKU product line is not only perfect for setting the scene for your dishes, you can also use it as a decorative accessory on your sideboard, for example. The trays are available in different shapes, sizes as well as colours. Thanks to the timeless design they fit ideally into your living spaces and meet all your requirements. The trays are made of FSC®-certified oak and can be cleaned with a damp cloth.

**OKU SERVIERTABLETT**

Machen Sie Servieren zum Highlight und lassen Sie Ihrer Kreativität in Sachen Tischdekoration freien Lauf. Die vielseitige Serie OKU eignet sich nicht nur hervorragend um Ihre Speisen perfekt in Szene zu setzen, Sie können diese auch als dekoratives Accessoire beispielsweise auf Ihrem Sideboard verwenden. Die Tablett sind sowohl in verschiedenen Formen, Größen als auch Farben erhältlich, sodass Sie sich dank des zeitlosen Designs ideal in Ihre Wohnräume einfügen und jedem Ihrer Ansprüche gerecht werden. Die Tablett bestehen aus FSC®-zertifizierter Eiche und können mit einem feuchten Tuch gereinigt werden.

**OKU 64548**

Tray | Serviertablett  
 Dimensions H 2 cm, Ø 34 cm  
 Materials H2  
 Colour Oak  
 Features Size: M

64548  
Oak



64550  
Black



**KASANE 67588**

Storage Box | Aufbewahrungsbox  
 Dimensions H 14 cm, B 25 cm, T 19,5 cm  
 Materials H12  
 Colour Moonbeam  
 Features Stackable  
 Stapelbar, Size: S

NEW



67588  
Moonbeam



67591  
Mourning Dove



67587  
Anthracite

**KASANE 67593**

Storage Box | Aufbewahrungsbox  
 Dimensions H 14 cm, B 25 cm, T 39 cm  
 Materials H12  
 Colour Moonbeam  
 Features Stackable  
 Stapelbar, Size: M

NEW



67593  
Moonbeam



67596  
Mourning Dove



67592  
Anthracite

**KASANE 67598**

Storage Box | Aufbewahrungsbox  
 Dimensions H 24,5 cm, B 25 cm, T 39 cm  
 Materials H12  
 Colour Moonbeam  
 Features Stackable  
 Stapelbar, Size: L

NEW



67598  
Moonbeam



67601  
Mourning Dove



67597  
Anthracite

**KASANE 67603**

Tray | Tablett  
 Dimensions H 3 cm, B 25 cm, B 39 cm  
 Materials H12  
 Colour Moonbeam  
 Features Stackable  
 Stapelbar, Size: L

NEW



67603  
Moonbeam



67606  
Mourning Dove



67602  
Anthracite

**KASANE STORAGE SOLUTIONS**

Colours that layer, shapes that fit together: KASANE is more than just a storage solution and was designed by Japanese designer Kazushige Miyake. Boxes and trays interlock, forming seamless lines and transforming tidying up into an aesthetic ritual. The name – Japanese for “stack” – sums up the idea perfectly.

**KASANE AUFBEWAHRUNGSLÖSUNGEN**

Farben, die sich schichten, Formen, die sich fügen: KASANE ist mehr als eine Aufbewahrungslösung und entworfen vom japanischen Designer Kazushige Miyake. Boxen und Tablett greifen ineinander, bilden nahtlose Linien und verwandeln Aufräumen in ein ästhetisches Ritual. Der Name – japanisch für „stapeln“ – bringt die Idee auf den Punkt.

**KASANE 67608**

Tray | Tablett  
 Dimensions H 3 cm, B 25 cm, B 19,5 cm  
 Materials H12  
 Colour Moonbeam  
 Features Stackable  
 Stapelbar, Size: S

NEW



67608  
Moonbeam



67611  
Mourning Dove



67607  
Anthracite







**KAGO – SIMPLE ORGANISATION**

Simple wire baskets become design objects: Kazushige Miyake's KAGO baskets combine function with sophistication. Powder-coated metal, stackable and versatile, looks light and modern. Their name simply means 'basket' in Japanese – a symbol of both order and beauty.

**KAGO – EINFACHES ORGANISIEREN**

Aus einfachen Drahtkörben werden Designobjekte: Die KAGO Körbe von Kazushige Miyake verbinden Funktion mit Raffinesse. Pulverbeschichtetes Metall, stapelbar und vielseitig, wirkt leicht und modern. Ihr Name bedeutet im Japanischen schlicht „Korb“ – ein Symbol für Ordnung und Schönheit zugleich.



**KAGO 64961**

Storage Basket | Aufbewahrungskorb  
 Dimensions H 14 cm, B 29 cm, T 21 cm  
 Materials S1b  
 Colour Moonbeam  
 Features Stackable, oval  
 Stapelbar, oval, Size: S



NEW



**KAGO 64971**

Storage Basket | Aufbewahrungskorb  
 Dimensions H 14 cm, B 29 cm, T 21 cm  
 Materials S1b  
 Colour Moonbeam  
 Features Stackable, square  
 Stapelbar, eckig, Size: S



NEW

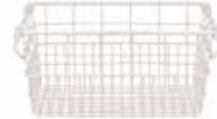

**KAGO 64966**

Storage Basket | Aufbewahrungskorb  
 Dimensions H 17 cm, B 37 cm, T 27 cm  
 Materials S1b  
 Colour Moonbeam  
 Features Stackable, oval  
 Stapelbar, oval, Size: M



NEW



**KAGO 64976**

Storage Basket | Aufbewahrungskorb  
 Dimensions H 17 cm, B 37 cm, T 27 cm  
 Materials S1b  
 Colour Moonbeam  
 Features Stackable, square  
 Stapelbar, eckig, Size: M



NEW

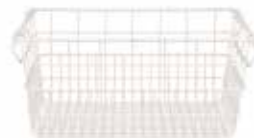

**SAHLA 68326**

Set of 2 Storage Boxes | Set 2 Aufbewahrungsboxen  
Dimensions H 11 cm, B 40 cm, T 30 cm  
H 7 cm, B 35 cm, T 25 cm  
Materials T10  
Colour Nomad



**SAHLA 68327**

Set of 2 Storage Boxes | Set 2 Aufbewahrungsboxen  
Dimensions H 11 cm, B 40 cm, T 30 cm  
H 7 cm, B 35 cm, T 25 cm  
Materials T10  
Colour Indian Tan



**SAHLA 68328**

Set of 2 Storage Boxes | Set 2 Aufbewahrungsboxen  
Dimensions H 11 cm, B 40 cm, T 30 cm  
H 7 cm, B 35 cm, T 25 cm  
Materials T10  
Colour Pewter

NEW



**SAHLA STORAGE BOXES**

Functional design, clear lines and a pleasant feel – the SAHLA box set offers you aesthetic storage options. Stow away your office utensils in style, store jewellery and cosmetics or collect bathroom accessories in one place.

The box set consists of two boxes of different sizes that can be closed with a lid. The PU suede cover gives the boxes an elegant look and makes them an eye-catcher on your desk, shelves or cupboards.

**SAHLA AUFBEWAHRUNGSBOXEN**

Funktionales Design, klare Linien und eine angenehme Haptik – das SAHLA Boxenset bieten Ihnen ästhetische Aufbewahrungsmöglichkeiten. Lassen Sie Ihre Bürountensilien stilvoll verschwinden, verstauen Sie Schmuck und Kosmetik oder sammeln Sie Badaccessoires an einem Ort.

Das Boxenset besteht aus zwei unterschiedlich großen Kisten, die mit einem Deckel verschlossen werden können. Der PU Wildlederbezug gibt den Boxen eine elegante Optik und sorgt für einen Hingucker auf Ihrem Schreibtisch, in Regalen oder Schränken.

**PONTO 65798**

Set of 4 Wall Hooks | Set 4 Wandhaken  
 Dimensions T 4,5 cm, Ø 8,5 cm, T 4,5 cm, Ø 5 cm  
 Materials ST3  
 Colour Lily White



65798  
Lily White



65800  
Gunmetal



67395 - NEW  
Black



65801  
Rose Dust, Elephant Skin,  
Winetasting, Gunmetal



66961  
Moonbeam, Cedar Wood,  
Nomad, Espresso



66962  
Warm Gray, Tradewinds,  
Micro Chip, Moonbeam



**KENA 66016**

Plant Stand | Pflanzgefäß mit Gestell  
 Dimensions H 55 cm, Ø 22 cm  
 Materials Sb  
 Colour Nomad  
 Features Only indoor use | Nur für  
Innenräume geeignet



66016  
Nomad



66017  
Mourning Dove



66018  
Steel Gray



**KENA 66019**

Plant Stand | Pflanzgefäß mit Gestell  
 Dimensions H 80,5 cm, Ø 29 cm  
 Materials Sb  
 Colour Nomad  
 Features Only indoor use | Nur für  
Innenräume geeignet



66019  
Nomad



66020  
Mourning Dove



66021  
Steel Gray



**CRONO 65436**

Radio Controlled Clock | Funkuhr  
 Dimensions T 4,5 cm, Ø 30,5 cm  
 Materials SSm, K3  
 Colour White  
 Features Incl. Battery  
Inkl. Batterie



65436  
White



65437  
Black



**CRONO 65894**

Radio Controlled Clock | Funkuhr  
 Dimensions T 4,5 cm, Ø 24 cm  
 Materials SSm, K3  
 Colour White  
 Features Incl. Battery  
Inkl. Batterie



65894  
White



65895  
Black





**ENTRA 66713**

Wall-mounted Door Stop | Wandtürstopper  
 Dimensions H 4 cm, Ø 2,5 cm  
 Materials SSb, K3  
 Colour Anthracite  
 Features Only indoor use | Nur für Innenräume geeignet



**ENTRA 66714**

Wall-mounted Door Stop | Wandtürstopper  
 Dimensions H 8 cm, Ø 2,5 cm  
 Materials SSb, K3  
 Colour Anthracite  
 Features Only indoor use | Nur für Innenräume geeignet



**STOP 66919**

Door Stop, 1 kg | Türstopper, 1 kg  
 Dimensions H 4,5 cm, Ø 9 cm  
 Materials SSI, K4  
 Colour Anthracite  
 Features Only indoor use | Nur für Innenräume geeignet



**ENTRA 65353**

Wall-mounted Door Stop | Wandtürstopper  
 Dimensions H 4 cm, Ø 2,5 cm  
 Materials SSm, K1



**ENTRA 65354**

Wall-mounted Door Stop | Wandtürstopper  
 Dimensions H 8 cm, Ø 2,5 cm  
 Materials SSm, K1



**STOP 66922**

Door Stop, 2 kg | Türstopper, 2 kg  
 Dimensions H 7 cm, Ø 9 cm  
 Materials SSb, K4  
 Colour Anthracite  
 Features Only indoor use | Nur für Innenräume geeignet



**STOP 68307**

Door Stop, 1 kg | Türstopper 1 kg  
 Dimensions H 4,5 cm, Ø 9 cm  
 Materials SSm, K1



**STOP 68306**

Door Stop, 2 kg | Türstopper 2 kg  
 Dimensions H 7 cm, Ø 9 cm  
 Materials SSm, K1



**WEDO 68308**

Door Wedge | Türkeil  
 Dimensions H 5 cm, B 12 cm  
 Materials SSm, K1





### REDO STORAGE BOXES

The REDO storage boxes are made of 100% paper pulp and are lightweight, stable and can be stacked. The different sizes offer storage space, keep things tidy and fit ideally into different environments thanks to their special yet discreet look. The sets of two boxes with lids are available in three sizes. The designer Robin Scholtysik is known for his interest in new materials and unconventional manufacturing processes. For the production, cardboard waste is collected in a factory, mixed with water and the resulting pulp mixture is shaped with the aid of vacuum and then dried under heat. As the moulds harden, they become durable storage solutions.

### REDO AUFBEWAHRUNGSBOXEN

Die REDO Aufbewahrungsboxen bestehen zu 100 % aus Papierzellstoff und sind leicht, stabil und stapelbar. Die verschiedenen Größen bieten Stauraum, sorgen für Ordnung und fügen sich dank ihrer besonderen und dennoch dezenten Optik ideal in verschiedene Umgebungen ein. Die Sets in drei Größen bestehen aus je zwei Boxen mit Deckel. Der Designer Robin Scholtysik ist bekannt für sein Interesse an neuen Materialien und unkonventionellen Herstellungsverfahren. Zur Herstellung werden Kartonfabrikabfälle gesammelt, mit Wasser vermischt und die daraus entstandene Zellstoffmischung mithilfe eines Vakuums in Form gebracht und anschließend unter Wärme getrocknet. Die Formen härten aus und werden zu haltbaren Aufbewahrungslösungen.

#### REDO 67058

Set of 2 Storage Boxes | Set 2 Aufbewahrungsboxen  
 Dimensions H 12 cm, B 23,5 cm, T 23,5 cm  
 Materials H3  
 Features 100% Paper pulp  
 100% Papierzellstoff, Size: S



#### REDO 67059

Set of 2 Storage Boxes | Set 2 Aufbewahrungsboxen  
 Dimensions H 15 cm, B 32,5 cm, T 32,5 cm  
 Materials H3  
 Features 100% Paper pulp  
 100% Papierzellstoff, Size: M



#### REDO 67060

Set of 2 Storage Boxes | Set 2 Aufbewahrungsboxen  
 Dimensions H 20 cm, B 30,5 cm, T 30,5 cm  
 Materials H3  
 Features 100% Paper pulp  
 100% Papierzellstoff, Size: L



#### LANCA 63262

Flip Hook | Klapphaken  
 Dimensions H 25,5 cm, B 2 cm, T 22 cm  
 Materials SSm, K3



#### WILO 66651

Wastepaper basket | Papierkorb  
 Dimensions H 30 cm, Ø 23,5 cm  
 Materials H1  
 Features Round  
 Rund



#### WILO 66659

Wastepaper basket | Papierkorb  
 Dimensions H 30 cm, B 28 cm, T 15 cm  
 Materials H1  
 Features Rectangular  
 Rechteckig





**MIRO 66959**

# Wall Mirror | Wandspiegel  
 Dimensions H 170 cm, B 60 cm, T 2 cm  
 Materials H2, Gk  
 Colour Oak  
 Features Including hanging strip and mounting material | Inklusive Aufhängeleiste und Montagematerial



**MIRO 66960**

# Wall Mirror | Wandspiegel  
 Dimensions H 170 cm, B 60 cm, T 2 cm  
 Materials H1, Gk  
 Colour Black  
 Features Including hanging strip and mounting material | Inklusive Aufhängeleiste und Montagematerial



**MIRO**

Discreet and yet special – MIRO wall mirrors are not only a practical living accessory for your rooms, but also lend them timeless elegance. MIRO harmoniously blends into any room and gives it depth. The mirror glass is surrounded by a wooden frame made of FSC®-certified wood.

MIRO mirrors are available in different versions: round and rectangular. You can also choose between the look in natural oak wood or black ash wood. An aluminium mounting strip with plugs and screws is included to mount the mirror directly on the wall.

**MIRO**

Dezent und doch besonders – die MIRO Wandspiegel sind nicht nur ein praktisches Wohnaccessoire für Ihre Räume, sondern verleihen ihnen auch zeitlose Eleganz. MIRO fügt sich harmonisch in jeden Raum ein und schenkt ihnen Tiefe. Das Spiegelglas wird von einem Holzrahmen aus FSC®-zertifiziertem Holz umrandet.

Die MIRO Spiegel sind in verschiedenen Ausführungen erhältlich: In rund und in rechteckig. Zudem können Sie sich zwischen dem Look in natürlichem Eichenholz oder in schwarzem Eschenholz entscheiden. Um den Spiegel direkt an die Wand montieren zu können, ist im Lieferumfang eine Aluminium-Befestigungsleiste mit Dübeln und Schrauben enthalten.

**MIRO 67095**

# Wall Mirror | Wandspiegel  
 Dimensions Ø 110 cm, T 2 cm  
 Materials H2, Gk, A  
 Colour Oak  
 Features Including hanging strip and mounting material | Inklusive Aufhängeleiste und Montagematerial



**MIRO 67096**

# Wall Mirror | Wandspiegel  
 Dimensions Ø 110 cm, T 2 cm  
 Materials H2, Gk, A  
 Colour Black  
 Features Including hanging strip and mounting material | Inklusive Aufhängeleiste und Montagematerial



**MEDA 31056**

Metal-Fluid, V 100 ml

Highly effective metal fluid MEDA for care, protection and cleaning of matt and polished metal surfaces indoors, such as stainless steel, aluminum, chrome as well as ceramics, wood, glass and plastics. NSF registered.

Hochwirksames Metal-Fluid MEDA für Pflege, Schutz und Reinigung von matten und polierten Metalloberflächen im Innenbereich, wie Edelstahl, Aluminium, Chrom sowie Keramik, Holz, Glas und Kunststoffe. NSF-registriert.





# Pallet delivery only. Nur Palettenversand.

**ASHI 66154**

5 pcs Fireplace Tool Set | Kaminbesteck Set 5 tlg.  
 Dimensions H 75,5 cm, Ø 22 cm  
 Materials Sb, H2, H5  
 Colour Black  
 Features T-Stand, Tong, Poker, Shovel, Bristle  
 T-Ständer, Zange, Haken, Schaufel, Besen



**ASHI 66155**

5 pcs Fireplace Tool Set | Kaminbesteck Set 5 tlg.  
 Dimensions H 75,5 cm, Ø 22 cm  
 Materials Sb, H2, H5  
 Colour Brown  
 Features T-Stand, Tong, Poker, Shovel, Bristle  
 T-Ständer, Zange, Haken, Schaufel, Besen



**ASHI – DESIGN BY KASCHKASCH**

A series name could not be more fitting: The term ASHI comes from the Japanese and means reed. The beautifully shaped fireplace set was designed by the design duo kaschkasch and is reminiscent of gently swaying reeds.

The oak wood handles contain a magnet that holds the fire irons securely on the coated stand. The ASHI assortment offers different variants for a comfortably warm fireplace atmosphere.

**ASHI – DESIGN VON KASCHKASCH**

Passender könnte ein Serienname nicht sein: Der Begriff ASHI stammt aus dem Japanischen und bedeutet übersetzt Schilf. Die formschöne Kamin-garnitur wurde vom Designduo kaschkasch entworfen und erinnert an sanft wiegende Schilfrohre.

In den Eichenholzgriffen befindet sich ein Magnet, der das Besteck am beschichteten Ständer sicher hält. Das ASHI-Sortiment bietet verschiedene Varianten für eine wohlig warme Kamin-Atmosphäre.

**ASHI 66156**

3 pcs Fireplace Tool Set | Kaminbesteck Set 3 tlg.  
 Dimensions H 75,5 cm, Ø 22 cm  
 Materials Sb, H2  
 Colour Black  
 Features T-Stand, Tong, Poker  
 T-Ständer, Zange, Haken



**ASHI 66157**

3 pcs Fireplace Tool Set | Kaminbesteck Set 3 tlg.  
 Dimensions H 75,5 cm, Ø 22 cm  
 Materials Sb, H2  
 Colour Brown  
 Features T-Stand, Tong, Poker  
 T-Ständer, Zange, Haken





**ASHI 67077**

Firewood Basket | Feuerholz Korb  
 Dimensions H 42 cm, Ø 45 cm  
 Materials Sb, H2  
 Colour Black

67077  
Black



67078  
Brown



**ASHI 66164**

Firewood Basket | Feuerholz Korb  
 Dimensions H 45 cm, Ø 35 cm  
 Materials Sb, H2  
 Colour Black

66164  
Black



66165  
Brown





SPECIAL

---

# CHRISTMAS

## CREATING SPECIAL MOMENTS

When the days get shorter and the evenings become cooler, one of the most wonderful times of the year begins: the anticipation of the festive season. It is a time when our homes become more than ever a place of warmth, memories and small, loving rituals. While outside the first frost covers the landscape, the magic of the season takes over inside. It's not just about glitz and glamour, but above all about self-expression – of our own style, mood and what the holidays mean to us. Some prefer calm, clean lines and natural materials that radiate tranquillity and allow us to focus on what is important. Others let it sparkle, celebrating the festive season with bright colours, ornaments that tell stories, and decorations that bring a smile to your face. Whether you accentuate your rooms discreetly or transform them into festive works of art, every piece contributes to the atmosphere. A delicate candle holder, a handmade pendant or a stylish star on top of the tree: all these things transform everyday spaces into something special.

The blomus Christmas items have been designed to capture precisely these moments – with a design language that is both timeless and emotional. Good design not only accompanies us through the season, but also becomes part of the stories we rewrite year after year. Perhaps it is precisely the interplay of the new and the familiar that makes Christmas so special. Be inspired – and create your very own festive world.

## ZEIT FÜR BESONDERE MOMENTE

Wenn die Tage kürzer und die Abende kühler werden, beginnt eine der schönsten Zeiten des Jahres: die Vorfreude auf die Festtage. Es ist die Zeit, in der unser Zuhause mehr denn je zu einem Ort der Wärme, der Erinnerungen und der kleinen, liebevollen Rituale wird. Während draußen der erste Frost die Landschaft überzieht, zieht drinnen der Zauber der Saison ein.

Dabei geht es nicht nur um Glanz und Glitzer, sondern vor allem um Ausdruck – des eigenen Stils, der Stimmung und dessen, was die Feiertage für uns bedeuten. Manche bevorzugen ruhige, klare Linien und natürliche Materialien, die Ruhe ausstrahlen und uns das Wesentliche spüren lassen. Andere lassen es funkeln und feiern das Fest in leuchtenden Farben, mit Ornamenten, die Geschichten erzählen, und Dekorationen, die zum Lächeln einladen. Ganz gleich, ob Sie Ihre Räume dezent akzentuieren oder sie in ein festliches Gesamtkunstwerk verwandeln – jedes Stück trägt zur Atmosphäre bei. Ein filigraner Kerzenhalter, ein handgefertigter Anhänger, ein stilvoller Stern auf der Baumspitze: All diese Dinge verwandeln Alltagsräume in etwas Besonderes.

Die blomus Weihnachtsartikel wurden entworfen, um genau diesen Momenten gerecht zu werden – mit einer Formsprache, die sowohl zeitlos als auch emotional ist. Denn gutes Design begleitet nicht nur durch die Saison, sondern wird Teil der Geschichten, die wir Jahr für Jahr neu schreiben. Vielleicht ist es gerade das Zusammenspiel von Neuem und Vertrautem, das Weihnachten so besonders macht. Lassen Sie sich inspirieren – und gestalten Sie Ihre ganz persönliche Festtagswelt.











DESIGNER

## NINA THÖMING

Designer Nina Thöming (born 1984) is part of the German design studio Flöz Design, which has been a stable partner to blomus for over 15 years. With a background in industrial design, Nina Thöming's work process is thorough and systematic, starting with research and a comprehensive uncovering of the needs and demands of the market followed by the creative process of transforming the acquired knowledge into beautiful yet functional interior items.

Her products for blomus include the Pilar tableware, the Sono bath accessories and the Lito lanterns. One of her latest designs for blomus is Lyva – a collection of indoor lanterns.

Die Designerin Nina Thöming (geb. 1984) ist Mitarbeiterin des deutschen Designstudios Flöz Design, das seit über 15 Jahren ein zuverlässiger Partner von blomus ist. Mit dem Hintergrundwissen des Industriedesigns arbeitet Nina Thöming systematisch. Sie beginnt ihren Arbeitsprozess mit der Recherche und dem Herausfinden von Anforderungen und Bedürfnissen des Marktes. Danach folgt der kreative Prozess, das Wissen in schöne, aber auch funktionale Einrichtungsgegenstände umzusetzen.

Zu ihren Produkten für blomus gehören unter anderem die Geschirrschüsselserie Pilar, die Badaccessoires Sono und die Laternen Lito. Eines ihrer neuesten Designs für blomus ist Lyva – eine Serie von Laternen für den Innenbereich.





Kazary, Kiseky







Juhla





**KAZARY – DESIGN BY NINA THÖMING**

KAZARY, designed by Nina Thöming from Flöz Design, is a collection of paper Christmas decorations. The name is derived from the Japanese term Kazari, which means embellishment, ornament or decoration.

KAZARY comprises various ornaments in the shape of a star, a crystal, a heart, a bell and an ellipse, each available in a set of four made of paper. These are complemented by the typical blomus satin ribbons in matching colours. With these, the ornaments can be hung at the desired height. The modern, timeless design of KAZARY can be perfectly combined and embellishes your Christmas surroundings.

**KAZARY – DESIGN VON NINA THÖMING**

KAZARY, design von Nina Thöming aus dem Hause Flöz Design, umfasst eine Kollektion aus Papierweihnachtsschmuck. Der Name ist abgeleitet von dem japanischen Begriff Kazari, der Ornament oder Dekoration bedeutet.

KAZARY umfasst verschiedene Ornamente in der Form von einem Stern, einem Kristall, einem Herz, einer Glocke und einer Ellipse, die jeweils in einem Vierer-Set aus Papier erhältlich sind. Ergänzt werden diese durch die für blomus typischen, farblich passenden Satinbänder. Mit diesen können Sie die Ornamente in gewünschter Höhe aufhängen. Das moderne, zeitlose Design von KAZARY lässt sich perfekt kombinieren und verschönert Ihre weihnachtliche Umgebung.

**KAZARY 68059**

Set of 4 Christmas Paper Stars |  
Weihnachtsschmuck - Papiersterne, 4 Stk.  
Dimensions H 10 cm, B 10 cm, T 2 cm  
Materials H3, T3  
Colour Moonbeam  
Features Handmade | Handgefertigt

**68059**  
Moonbeam



**68064**  
Tan



**KAZARY 68060**

Set of 4 Christmas Paper Crystals |  
Weihnachtsschmuck - Papierkristalle, 4 Stk.  
Dimensions H 10 cm, B 10 cm, T 3,5 cm  
Materials H3, T3  
Colour Moonbeam  
Features Handmade | Handgefertigt

**68060**  
Moonbeam



**68065**  
Tan



**KAZARY 68061**

Set of 4 Christmas Paper Hearts |  
 Weihnachtsschmuck - Papierherzen, 4 Stk.  
 Dimensions H 6,5 cm, B 7 cm  
 Materials H3, T3  
 Colour Moonbeam

**68061**  
Moonbeam



**68066**  
Tan

**KAZARY 68062**

Set of 4 Christmas Paper Bells |  
 Weihnachtsschmuck - Papierglocken, 4 Stk.  
 Dimensions H 6,5 cm, B 7 cm  
 Materials H3, T3  
 Colour Moonbeam

**68062**  
Moonbeam



**68067**  
Tan

**KAZARY 68063**

Set of 4 Christmas Paper Ellipses |  
 Weihnachtsschmuck - Papierellipsen, 4 Stk.  
 Dimensions H 4 cm, B 12 cm  
 Materials H3, T3  
 Colour Moonbeam

**68063**  
Moonbeam



**68068**  
Tan

**KISEKY 63227**

Set of 4 Christmas Ornaments Glass Baubles |  
 Weihnachtsschmuck - Glaskugeln, 4 Stk.  
 Dimensions Ø 7 cm  
 Materials Gf, T3  
 Colour Oak

**KISEKY – CHRISTMAS INSPIRED BY NATURE**

The KISEKY Christmas glass baubles give your home a particularly warm and natural atmosphere in a stylish way thanks to their wooden look. Perfect for the festive season!

The simple wooden structure of the baubles with their matt finish combines naturalness with a modern, festive design. KISEKY is supplied in a set of four with a ribbon in a matching colour.

**KISEKY – NATÜRLICH INSPIRIERTES WEIHNACHTEN**

Die KISEKY Weihnachtsglaskugeln verleihen Ihrem Zuhause dank ihrer Holzoptik auf stilvolle Weise eine besonders warme und natürliche Atmosphäre. Perfekt für die besinnliche Zeit!

Die schlichte Holzstruktur der Kugeln mit dem matten Finish vereint Natürlichkeit mit modernem, festlichem Design. KISEKY wird in einem Vierer-Set mit einem farblich passendem Band geliefert.

**KITAI 68034**

Christmas Tree Top Star |  
Weihnachtsbaumspitze

Dimensions H 26,5 cm, B 15,5 cm, T 13 cm

Materials S1

Colour Brass

Features Weight 79 g | Gewicht 79 g,  
Size: S

**68034**  
Brass



**68035**  
Silver

**KITAI 67156**

Christmas Tree Top Star |  
Weihnachtsbaumspitze

Dimensions H 30 cm, B 19,5 cm, T 13,5 cm

Materials S1

Colour Brass

Features Weight 118 g | Gewicht 118 g,  
Size: M

**67156**  
Brass



**67157**  
Silver

**KITAI TREE TOP STARS**

The range of Christmas decorations from the KITAI series is perfectly rounded off by the KITAI Christmas tree top star, which consists of a large, outer star framing two smaller stars. The top makes your Christmas tree the shining centrepiece of your festive home.

The star is made of coated iron and placed on a spring that can be used to attach the star to your tree.

**KITAI WEIHNACHTSBAUMSPITZEN**

Das Sortiment an Weihnachtsschmuck aus der Serie KITAI wird perfekt abgerundet durch die Weihnachtsbaumspitze KITAI, die aus einem großen, äußeren Stern besteht, der zwei kleinere Sterne umrahmt. Die Spitze macht Ihren Christbaum zum strahlenden Mittelpunkt Ihres feierlichen Zuhauses.

Der Stern ist hergestellt aus beschichtetem Eisen und auf einer Feder platziert, mit der der Stern an Ihrem Baum befestigt werden kann.



**KITAI 66963**

Set of 4 Christmas Ornaments Glass Baubles |  
 Weihnachtsschmuck - Glaskugeln, 4 Stück  
 Dimensions H 8,5 cm, B 5 cm, Ø 8 cm  
 Materials S1, Gk, T3 Iron with Brass Finish  
 Colour Clear



66963  
Clear



66611  
Smoke



66612  
Coffee



66614  
Port



**KITAI 67100**

Set of 4 Christmas Ornaments Glass Baubles |  
 Weihnachtsschmuck - Glaskugeln, 4 Stk.  
 Dimensions H 8,5 cm, B 5 cm, Ø 8 cm  
 Materials S1, Gk, T3 Iron with Silver Finish  
 Colour Clear



67100  
Clear



67097  
Smoke



67098  
Coffee



67099  
Port



**KITAI 66608**

Set of 4 Christmas Ornaments Stars |  
 Weihnachtsschmuck - Sterne, 4 Stück  
 Dimensions H 8,5 cm, Ø 8 cm  
 Materials S1, T3 Iron with Brass Finish  
 Features Includes two Ribbons,  
 coloured Satellite and Port  
 Beiliegend zwei Satinbänder der  
 Farben Satellite und Port



66608  
Star



66609  
Bell



66610  
Circle



**KITAI 67101**

Set of 4 Christmas Ornaments Stars |  
 Weihnachtsschmuck - Sterne, 4 Stk.  
 Dimensions H 8,5 cm, Ø 8 cm  
 Materials S1, T3 Iron with Silver Finish  
 Features Includes two Ribbons,  
 coloured Moonbeam and Port  
 Beiliegend zwei Satinbänder der  
 Farben Moonbeam und Port



67101  
Star



67102  
Bell



67103  
Circle





#### JUHLA CHRISTMAS BAUBLES

Spread festive joy in your home with the JUHLA Christmas baubles! The baubles are simple in their shape, yet special in their appearance. Each set features modern Christmas colours with a matt finish. With a ribbon in a matching colour, the baubles create a harmonious overall look and can be hung at the desired height.

#### JUHLA WEIHNACHTSKUGELN

Verbreiten Sie festliche Freude in Ihrem Zuhause mit den JUHLA Weihnachtskugeln! Die Kugeln sind schlicht in ihrer Form, aber dennoch besonders in ihrer Ausstrahlung. Jedes Set präsentiert weihnachtliche, moderne Farben, die durch ein mattes Finish veredelt werden. Mit einem farblich passenden Band versehen, bilden die Kugeln ein harmonisches Gesamtbild und können in gewünschter Höhe aufgehängt werden.

#### JUHLA 67155

Set of 6 Christmas Ornaments Glass Baubles |  
Weihnachtsschmuck - Glaskugeln, 6 Stk.  
Dimensions Ø 5 cm  
Materials Gf, T3  
Colour Smoke, Coffee, Clear  
Features Size: S



67155  
Smoke, Coffee, Clear



67154  
Midnight Plum, Port, Rustic Brown



**JUHLA 63219**

Set of 4 Christmas Ornaments Glass Baubles |  
 Weihnachtsschmuck - Glaskugeln, 4 Stk.  
 Dimensions Ø 7 cm  
 Materials Gf, T3  
 Colour Midnight Plum  
 Features Size: M



63219  
Clear

63220  
Coffee

63221  
Smoke

63217  
Midnight Plum

63216  
Port

63218  
Rustic Brown

**JUHLA 68040**

Set of 2 Christmas Ornaments Glass Baubles |  
 Weihnachtsschmuck - Glaskugeln, 2 Stk.  
 Dimensions Ø 9 cm  
 Materials Gf, T3  
 Features Size: L



68040  
Clear

68041  
Coffee

68039  
Smoke

68036  
Midnight Plum

68037  
Port

68038  
Rustic Brown

**JUHLA 68058**

Gift Ribbon | Geschenkband  
 Dimensions Ø 6,5 cm, H 4,5 cm  
 Materials T3, H3  
 Colour Moonbeam  
 Features Length 500 cm, Width 1 cm  
 Länge 500 cm, Breite 1 cm



68058  
Moonbeam

68057  
Coffee

68056  
Smoke

68054  
Midnight Plum

68055  
Port

**VELA 67135**

Candle Holder | Kerzenhalter  
 Dimensions H 3 cm, B 40 cm, T 14 cm  
 Materials ST2  
 Colour Moonbeam  
 Features Suitable for Ø 22 mm candles  
 Passend für Ø 22 mm Kerzen



67135  
Moonbeam



67134  
Satellite



67133  
Black



67136  
Agave Green

**VELA 66615**

Candle holder | Kerzenhalter  
 Dimensions H 3,5 cm, Ø 27 cm  
 Materials ST2  
 Colour Moonbeam  
 Features Suitable for Ø 22 mm candles  
 Passend für Ø 22 mm Kerzen



66615  
Moonbeam



67152  
Satellite



66707  
Black



66616  
Agave Green



67153  
Amber Brown

**NOX 66979**

Candle Snuffer | Kerzenlöscher  
 Dimensions H 5,5 cm, B 3,5 cm, T 23 cm  
 Materials Zd  
 Colour Brass, metallic finish



**NOX 66980**

Candle Snuffer | Kerzenlöscher  
 Dimensions H 5,5 cm, B 3,5 cm, T 23 cm  
 Materials Zd  
 Colour Burned Metal, metallic finish



**NOX**

The NOX candle snuffer allows to extinguish candles without odor. At the same time, wax stains and soot, which can occur when blowing out candles, are avoided. The metallic shimmering surfaces fit extremely well with other blomus articles in the range.

**NOX**

Der NOX Kerzenlöscher ermöglicht es, Kerzen geruchlos zu löschen. Gleichzeitig werden Wachsflecken und Ruß, die beim Auspusten von Kerzen entstehen können, vermieden. Die metallisch schimmernden Oberflächen passen ausgesprochen gut zu anderen blomus Artikeln im Sortiment.







PRODUCTS

---

# BATH ESSENTIALS

BATH ACCESSORY	P. 224
TEXTILES	P. 252
STORAGE	P. 264

## BATH ESSENTIALS

### AVA 67410

Soap Dispenser | Seifenspender  
 Dimensions H 13,5 cm, Ø 8 cm, V 250 ml  
 Materials Gk, K3  
 Colour White

NEW



67410  
White



67415  
Tan



67420  
Black

### AVA 67411

Tumbler | Zahnputzbecher  
 Dimensions H 11 cm, Ø 8 cm  
 Materials Gk  
 Colour White

NEW



67411  
White



67416  
Tan



67421  
Black

### AVA 67412

Storage Box | Aufbewahrungsdose  
 Dimensions H 6,5 cm, Ø 8 cm  
 Materials Gk, K3  
 Colour White

NEW



67412  
White



67417  
Tan



67422  
Black

### AVA 67413

Toilet Brush | WC-Bürste  
 Dimensions H 39 cm, Ø 11 cm  
 Materials K3, K4, SSp  
 Colour White

NEW



67413  
White



67418  
Tan



67423  
Black

### AVA 67414

Pedal Bin | Treteimer  
 Dimensions H 23,5 cm, Ø 21,5 cm, 3 l  
 Materials K3, K4  
 Colour White  
 Features Soft Close  
 Soft Close

NEW



67414  
White



67419  
Tan



67424  
Black

### AVA – DESIGN BY NADINE KÜMMEL

Delicate curves, clean lines – the AVA bathroom series by Nadine Kümmel combines functionality with feminine elegance. Hand-blown glass brings together strength and delicacy, while the 3-litre pedal bin cleverly combines hygiene and aesthetics. AVA transforms the bathroom into a place of harmony and style.

### AVA – DESIGN VON NADINE KÜMMEL

Zarte Kurven, klare Linien – die AVA Badserie von Nadine Kümmel vereint Funktionalität mit femininer Eleganz. Mundgeblasenes Glas bringt Stärke und Feinheit zusammen, während der 3-Liter-Treteimer Hygiene und Ästhetik auf smarte Weise verbindet. AVA macht das Badezimmer zu einem Ort von Harmonie und Stil.





**MODO ROF 67498**

Soap Dispenser | Seifenspender  
 Dimensions H 16 cm, T 7,5 cm, Ø 5,5 cm, V 165 ml  
 Materials SSt, K1, K3  
 Colour White

NEW



67498  
White



67494  
Black



67510  
Stainless Steel



67502  
Brass



67506  
Burned Metal



**MODO ROF 67499**

Tumbler | Zahnputzbecher  
 Dimensions H 12 cm, Ø 5,5 cm  
 Materials SSt, K1  
 Colour White

NEW



67499  
White



67495  
Black



67511  
Stainless Steel



67503  
Brass



67507  
Burned Metal



**MODO ROF 67500**

Toilet Brush | WC-Bürste  
 Dimensions H 49 cm, Ø 8,5 cm  
 Materials SSt, K1, K3  
 Colour White

NEW



67500  
White



67496  
Black



67512  
Stainless Steel



67504  
Brass



67508  
Burned Metal





# BATH ESSENTIALS

## MODO ROF 67501

Toilet Paper Holder | WC-Rollenhalter  
 Dimensions H 9 cm, B 13 cm, T 2,5 cm  
 Materials SSt  
 Colour White

NEW



67501  
White



67497  
Black



67513  
Stainless Steel



67505  
Brass



67509  
Burned Metal

## MODO ROF 67556

Wall-mounted Soap Dispenser |  
 Seifenspender mit Wandhalterung  
 Dimensions H 16 cm, T 9 cm, Ø 5,5 cm, V 165 ml  
 Materials SSt, K1, K3  
 Colour White

NEW



67556  
White



67555  
Black



67559  
Stainless Steel



67557  
Brass



67558  
Burned Metal

## MODO ROF 67561

Wall-mounted Toilet Brush | WC-Bürste mit Wand-  
 halterung  
 Dimensions H 49 cm, T 10,5 cm, Ø 8,5 cm  
 Materials SSt, K1, K3  
 Colour White

NEW



67561  
White



67560  
Black



67564  
Stainless Steel



67562  
Brass



67563  
Burned Metal



## BATH ESSENTIALS

### KUA – SUSTAINABLE AND TIMELESS

KUA, the bathroom series by Swedish designer Anton Björnsing, is made from 50% recycled polyresin. Polyresin is made from ground stone and plastic and is characterised by its high durability and robustness. In keeping with this, the designer has chosen a shape reminiscent of the architecture of a column in order to combine the robust material with its simplicity and strength.

### KUA – NACHHALTIG UND ZEITLOS

KUA, die Badserie vom schwedischen Designer Anton Björnsing, wird aus 50% recyceltem Polyresin hergestellt. Polyresin wird aus gemahlenem Stein und Kunststoff hergestellt und zeichnet sich durch seine hohe Langlebigkeit und Robustheit aus. In Einklang dazu hat der Designer die Form gewählt die an die Architektur einer Säule erinnert, um das robuste Material mit seiner Einfachheit und Stärke zu vereinen.



### KUA 67365

Soap Dispenser | Seifenspender

Dimensions H 16,5 cm, B 7 cm, T 8 cm, V 300 ml

Materials ST8r, K3r

Colour Moonbeam

Features 50% Recycled Polyresin,  
50% recycled ABS  
50% Recyceltes Polyresin,  
50% recyceltes ABS



**67365**  
Moonbeam



**67375**  
Micro Chip



**67370**  
Magnet



**67380**  
Cedar Wood

### KUA 67366

Tumbler | Zahnputzbecher

Dimensions H 11 cm, Ø 7 cm

Materials ST8r

Colour Moonbeam

Features 50% Recycled Polyresin  
50% Recyceltes Polyresin



**67366**  
Moonbeam



**67376**  
Micro Chip



**67371**  
Magnet



**67381**  
Cedar Wood

**KUA 67367**

Toilet Brush | WC-Bürste  
 Dimensions H 39 cm, Ø 11 cm  
 Materials ST8r, K3r  
 Colour Moonbeam  
 Features 50% Recycled Polyresin,  
 50% recycled ABS  
 50% Recycltes Polyresin,  
 50% recyceltes ABS



**67367**  
Moonbeam



**67377**  
Micro Chip



**67372**  
Magnet



**67382**  
Cedar Wood



**KUA 67368**

Soap Dish | Seifenschale  
 Dimensions H 3,5 cm, Ø 11 cm  
 Materials ST8r  
 Colour Moonbeam  
 Features 50% Recycled Polyresin,  
 50% Recycltes Polyresin



**67368**  
Moonbeam



**67378**  
Micro Chip



**67373**  
Magnet



**67383**  
Cedar Wood



**KUA 67369**

Pedal Bin | Treteimer  
 Dimensions H 26 cm, Ø 20 cm, V 3 l  
 Materials ST8r, K3r  
 Colour Moonbeam  
 Features 50% Recycled Polyresin,  
 50% recycled ABS  
 50% Recycltes Polyresin,  
 50% recyceltes ABS



**67369**  
Moonbeam



**67379**  
Micro Chip



**67374**  
Magnet



**67384**  
Cedar Wood



**MODO 65508**

Soap Dispenser | Seifenspender  
 Dimensions H 16 cm, T 7,5 cm, Ø 5,5 cm,  
 V 165 ml  
 Materials SSm, K1, K3  
 Colour Matt

65508  
 Matt



65521  
 Polished



**MODO 65514**

Wall-mounted Soap Dispenser |  
 Seifenspender mit Wandhalterung  
 Dimensions H 16 cm, T 9 cm, Ø 5,5 cm,  
 V 165 ml  
 Materials SSm, K1, K3  
 Colour Matt

65514  
 Matt



65527  
 Polished



**MODO 65510**

Tumbler | Zahnputzbecher  
 Dimensions H 12 cm, Ø 5,5 cm  
 Materials SSm, K1  
 Colour Matt

65510  
 Matt



65523  
 Polished



**MODO 65511**

Toilet Paper Holder | WC-Rollenhalter  
 Dimensions H 9 cm, B 13 cm, T 2,5 cm  
 Materials SSm, Ab, K1  
 Colour Matt

65511  
 Matt



65524  
 Polished



**MODO 65519**

Toilet Paper Holder with Tray |  
 WC-Rollenhalter mit Ablage  
 Dimensions H 9,5 cm, B 14,5 cm,  
 T 13,5 cm  
 Materials SSm, Ab, K1  
 Colour Matt

65519  
 Matt



65532  
 Polished



**MODO 65513**

Wall Hook | Wandhaken  
 Dimensions H 6 cm, B 1,5 cm, T 3 cm  
 Materials SSm  
 Colour Matt

65513  
 Matt



65526  
 Polished





**MODO 65509**

Toilet Brush | WC-Bürste  
 Dimensions H 49 cm, Ø 8,5 cm  
 Materials SSm, K1, K3  
 Colour Matt

65509  
 Matt



65522  
 Polished



**MODO 65515**

Wall-mounted Toilet Brush |  
 WC-Bürste mit Wandhalterung  
 Dimensions H 49 cm, T 10,5 cm,  
 Ø 8,5 cm  
 Materials SSm, K1, K3  
 Colour Matt

65515  
 Matt



65528  
 Polished



**MODO 65516**

Toilet Paper Holder and Brush |  
 Toilettenbutler  
 Dimensions H 66 cm, B 15 cm, T 19 cm  
 Materials SSm, ST5, K1, K3  
 Colour Matt

65516  
 Matt



65529  
 Polished



**MODO 65520**

Wall Shelf | Wandregal  
 Dimensions H 4,5 cm, B 51,5 cm,  
 T 10,5 cm  
 Materials SSm  
 Colour Matt

65520  
 Matt



65533  
 Polished



**MODO 67566**

Towel Rack | Handtuchhalter  
 Dimensions H 86 cm, B 60 cm, T 18,5 cm  
 Materials SSm  
 Colour Matt

67566  
 Matt



NEW



67567  
 Polished

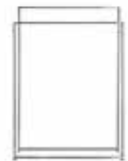

**MODO 65512**

Vanity Mirror | Kosmetikspiegel  
 Dimensions H 28 cm, B 20 cm, T 10 cm  
 Materials SSm, K1, K3  
 Colour Matt  
 Features Rotatable, 5 time magnifying | Mit beweglicher Spiegelfläche, mit 5-fach Vergrößerung

65512  
Matt



65525  
Polished

**MODO 65517**

LED Vanity Mirror | LED Kosmetikspiegel  
 Dimensions H 34,5 cm, B 20 cm, T 14 cm  
 Materials SSm, K1, K3  
 Colour Matt  
 Features Rotatable, 5 time magnifying | Mit beweglicher Spiegelfläche, 5-fach Vergrößerung

65517  
Matt



65530  
Polished

**MODO 65518**

Wall-mounted LED Vanity Mirror |  
 LED Kosmetikspiegel mit Wandhalterung  
 Dimensions H 20 cm, B 20 cm, T 30,5 cm  
 Materials SSm, K1, K3  
 Colour Matt  
 Features Rotatable, swivel-type, 5 time magnifying  
 Schwenkbar, mit beweglicher Spiegelfläche, 5-fach Vergrößerung

65518  
Matt



65531  
Polished



**MODO - LED VANITY MIRROR**

The MODO LED cosmetic mirror is the ideal companion for taking personal cosmetics to the next level. 5-fold magnification and the 360° swivelling / removable mirror surface offer the best conditions for this. The LED illuminated ring is activated via an intuitive control element and then you can choose from 3 different light colours as required. In addition, different light intensities can be set with the help of the dimming function. Designed by Nina Thöming (Flöz Design), the mirror is mobile on account of its built-in rechargeable battery. If the battery is discharged, it can be quickly recharged with the USB-C cable (included).

Luminous flux: 500 – 1000 Lumen, Output: 4 – 8 W  
 Voltage: DC 3.7 V, Protection class: III  
 Water tightness: IP 44, Luminous colour: 3000 K / 4200 K / 6000 K  
 Input: 5V/DC 1A, Operation time: 8 hours

**Features:**  
 Touchbutton, 3 Luminous Colours, Dimming function, 360° moveable and removable mirror, 5 x Magnification

**MODO- LED KOSMETIKSPIEGEL**

Der MODO LED Kosmetikspiegel ist der ideale Begleiter, um die persönliche Kosmetik auf das nächste Level zu bringen. Die 5-fach Vergrößerung sowie die 360° schwenkbare und abnehmbare Spiegelfläche bieten hierfür die besten Voraussetzungen. Über ein intuitives Bedienelement wird der LED Leuchtring aktiviert, um dann je nach Bedarf aus 3 unterschiedlichen Lichtfarben auszuwählen. Zusätzlich können mit Hilfe der Dimmfunktion verschiedene Lichtstärken eingestellt werden. Der von Nina Thöming (Flöz Design) entworfene Spiegel ist aufgrund eines verbauten Akkus mobil einsetzbar. Ist dieser entladen, ist eine schnelle Aufladung mit dem beigefügten USB-C Kabel garantiert.

Lichtstrom: 500 – 1000 Lumen, Leistung: 4 – 8 W  
 Spannung: DC 3,7 V, Schutzklasse: III  
 Wasserdichtigkeit: IP 44, Lichtfarbe: 3000 K / 4200 K / 6000 K  
 Input: 5V/DC 1A, Brenndauer: 8 Stunden

**Features:**  
 Einfache Bedienung über Touchbutton, 3 Lichtfarben + Dimmfunktion 360° schwenkbare und abnehmbare Spiegelfläche, 5 x Vergrößerung



**MODO 66457**

Soap Dispenser | Seifenspender  
 Dimensions H 16 cm, T 7,5 cm,  
 Ø 5,5 cm, V 165 ml  
 Materials SSt, K1, K3  
 Colour Brass, metallic finish



**66457**  
 Brass, metallic finish



**66462**  
 Burned Metal, metallic finish



**TUBO 65811**

Pedal Bin | Treteimer  
 Dimensions H 24,5 cm, Ø 17 cm, V 3 l  
 Materials SS2, K3  
 Colour Brass, metallic finish  
 Features With removable bucket  
 Mit herausnehmbarem Eimer



**65811**  
 Brass, metallic finish



**65812**  
 Burned Metal, metallic finish



**MODO 66458**

Tumbler | Zahnputzbecher  
 Dimensions H 12 cm, Ø 5,5 cm  
 Materials SSt, K1  
 Colour Brass, metallic finish



**66458**  
 Brass, metallic finish



**66463**  
 Burned Metal, metallic finish



**MODO 66459**

Wall Hook | Wandhaken  
 Dimensions H 6 cm, B 1,5 cm, T 3 cm  
 Materials SSt, K1  
 Colour Brass, metallic finish



**66459**  
 Brass, metallic finish



**66464**  
 Burned Metal, metallic finish



**MODO 66460**

Toilet Brush | WC-Bürste  
 Dimensions H 49 cm, Ø 8,5 cm  
 Materials SSt, K1, K3  
 Colour Brass, metallic finish



**66460**  
 Brass, metallic finish



**66465**  
 Burned Metal, metallic finish



**MODO 66461**

Toilet Paper Holder | WC-Rollenhalter  
 Dimensions H 9 cm, B 13 cm, T 2,5 cm  
 Materials SSt  
 Colour Brass, metallic finish



**66461**  
 Brass, metallic finish



**66466**  
 Burned Metal, metallic finish



**MODO 66264**

Soap Dispenser | Seifenspender  
 Dimensions H 16 cm, T 7,5 cm, Ø 5,5 cm,  
 V 165 ml  
 Materials SSt, K1, K3  
 Colour White

66264  
 White



69080  
 Black



**MODO 66269**

Wall-mounted Soap Dispenser |  
 Seifenspender mit Wandhalterung  
 Dimensions H 16 cm, T 9 cm, Ø 5,5 cm,  
 V 165 ml  
 Materials SSt, K1, K3  
 Colour White

66269  
 White



66259  
 Black



**MODO 66266**

Tumbler | Zahnputzbecher  
 Dimensions H 12 cm, Ø 5,5 cm  
 Materials SSt, K1  
 Colour White

66266  
 White



69082  
 Black



**MODO 66268**

Wall Hook | Wandhaken  
 Dimensions H 6 cm, B 1,5 cm, T 3 cm  
 Materials SSt  
 Colour White

66268  
 White



69086  
 Black



**MODO 66271**

Guest Towel Holder | Gästehandtuchhalter  
 Dimensions H 47 cm, B 7 cm, T 8 cm  
 Materials SSt  
 Colour White

66271  
 White



66261  
 Black



**MODO 66272**

Towel Ladder | Handtuchleiter  
 Dimensions H 170 cm, B 55,5 cm,  
 T 13,5 cm  
 Materials SSt, K1  
 Colour White

66272  
 White



66262  
 Black



**MODO 66265**

Toilet Brush | WC-Bürste  
 Dimensions H 49 cm, Ø 8,5 cm  
 Materials SSt, K1, K3  
 Colour White

66265  
 White



69081  
 Black



**MODO 66270**

Wall-mounted Toilet Brush |  
 WC-Bürste mit Wandhalterung  
 Dimensions H 49 cm, T 10,5 cm,  
 Ø 8,5 cm  
 Materials SSt, K1, K3  
 Colour White

66270  
 White



66260  
 Black



**MODO 66267**

Toilet Paper Holder | WC-Rollenhalter  
 Dimensions H 9 cm, B 13 cm, T 2,5 cm  
 Materials SSt  
 Colour White

66267  
 White



69083  
 Black



**MODO 66440**

Twin Towel Rail | Doppel-Handtuchhalter  
 Dimensions H 9 cm, B 60 cm, T 12,5 cm  
 Materials SSt  
 Colour White

66440  
 White

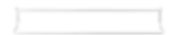

66439  
 Black



**MODO 66456**

Towel Rail | WC-Rollenhalter mit Ablage  
 Dimensions H 9,5 cm, B 14,5 cm, T 13,5 cm  
 Materials SSt  
 Colour Black



**MODO 69084**

Towel Rail | Handtuchstange  
 Dimensions H 11,5 cm, B 1,5 cm, T 46 cm  
 Materials SSt  
 Colour Black  
 Features Swivel-type  
 Schwenkbar



**MODO 69085**

Vanity Mirror | Kosmetikspiegel  
 Dimensions H 28 cm, B 20 cm, T 10 cm  
 Materials SSt, K1, K4  
 Colour Black  
 Features Rotatable, 5 time magnifying  
 Mit beweglicher Spiegelfläche,  
 mit 5-fach Vergrößerung



**MODO 66351**

LED Vanity Mirror | LED Kosmetikspiegel  
 Dimensions H 34,5 cm, B 20 cm, T 14 cm  
 Materials SSt, K1  
 Colour White  
 Features Rotatable, 5 x Magnification  
 Mit beweglicher Spiegel-  
 fläche, 5 x Vergrößerung

**66351**  
White



**66350**  
Black



**MODO 66353**

Wall-mounted LED Vanity Mirror |  
 LED Kosmetikspiegel mit Wandhalterung  
 Dimensions H 20 cm, B 20 cm, T 30,5 cm  
 Materials SSt, K1  
 Colour White  
 Features Rotatable, swivel-type,  
 5 x Magnification  
 Schwenkbar, mit beweglicher  
 Spiegelfläche,  
 5 x Vergrößerung

**66353**  
White



**66352**  
Black



**MODO 69244**

Shower Shelf | Wandhaken  
 Dimensions H 6,5 cm, B 34 cm, T 10 cm  
 Materials SSt  
 Colour White  
 Features Can be mounted without  
 drilling - Glue kit can be  
 purchased separately, item  
 no. 68809 | Auch ohne  
 Bohren montierbar -  
 Klebeset separat erhältlich,  
 Nr. 68809

**69244**  
White



**66329**  
Black

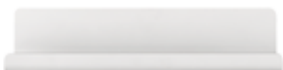

**MODO 69206**

Wall Shelf | Wandregal  
 Dimensions H 4,5 cm, B 71 cm, T 10,5 cm  
 Materials SSt  
 Colour Black  
 Features Suitable for the MODO trays  
 Passend für MODO Ablageschalen



**MODO 69205**

Wall Shelf | Wandregal  
 Dimensions H 4,5 cm, B 51 cm, T 10,5 cm  
 Materials SSt  
 Colour Black  
 Features Suitable for the MODO trays  
 Passend für MODO Ablageschalen



**MODO 68845**

Shower Squeegee, includes overdoor hook |  
 Duschwischer mit Halter  
 Dimensions B 27 cm, H 22 cm, T 3,5 cm  
 Materials SSt, K4  
 Colour Black



**MODO 69258**

Wiper | Bodenwischer  
 Dimensions H 122 cm, B 36 cm, T 2 cm  
 Materials SSt, K3, K4  
 Colour Black  
 Features Includes wall bracket  
 Mit Wandhalterung



**MODO 67322**

Pedal Bin | Treteimer  
 Dimensions H 25,5 cm, Ø 17,5 cm, V 3 l  
 Materials Sb, K3  
 Colour White  
 Features Soft Close, Carbon filter  
 Soft Close, Kohlefilter



67322  
White



67321  
Black



67323  
Burned Metal, metallic finish



67324  
Brass, metallic finish

**MODO 67565**

Towel Rack | Handtuchhalter  
 Dimensions H 86 cm, B 60 cm, T 18,5 cm  
 Materials SSb  
 Colour Black

NEW



**MODO 66263**

Toilet Paper Holder and Brush | Toilettenbutler  
 Dimensions H 66 cm, B 15 cm, T 19 cm  
 Materials SSt, ST5, K1, K3  
 Colour Black





**SONO 66273**

Soap Dispenser | Seifenspender  
 Dimensions H 14 cm, T 9,5 cm, Ø 8,5 cm, V 250 ml  
 Materials ST2, K3, K4  
 Colour White



66273  
White



69063  
Micro Chip



66274  
Black



69054  
Moonbeam



69046  
Satellite



69039  
Magnet



67235 - NEW  
Amber Brown



66370  
Tan



67549 - NEW  
Mazarine Blue



**SONO 66275**

Tumbler | Zahnputzbecher  
 Dimensions H 11 cm, Ø 8,5 cm  
 Materials ST2  
 Colour White



66275  
White



69066  
Micro Chip



66276  
Black



69057  
Moonbeam



69048  
Satellite



69041  
Magnet



67236 - NEW  
Amber Brown



66372  
Tan



67550 - NEW  
Mazarine Blue



**SONO 66277**

Tray | Tablett  
 Dimensions H 2,5 cm, B 10 cm, T 19 cm  
 Materials ST2  
 Colour White



66277  
White



69068  
Micro Chip



66278  
Black



69060  
Moonbeam



69050  
Satellite



69043  
Magnet



66898 - NEW  
Amber Brown



66374  
Tan



67553 - NEW  
Mazarine Blue





# BATH ESSENTIALS

## SONO 66292

Soap Dish | Seifenschale  
 Dimensions H 1,8 cm, B 10 cm, T 13 cm  
 Materials ST2  
 Colour White



66292  
White



66289  
Micro Chip



66293  
Black



66288  
Moonbeam



66287  
Satellite



66286  
Magnet



66384  
Tan



## SONO 66279

Vanity Mirror | Kosmetikspiegel  
 Dimensions H 18,5 cm, B 17 cm, T 9 cm  
 Materials ST2, K4  
 Colour White  
 Features 5 time magnifying  
 Mit 5-fach Vergrößerung



66279  
White



69163  
Micro Chip



66280  
Black



69162  
Moonbeam



69161  
Satellite



69160  
Magnet



66376  
Tan



## SONO 66327

Pedal Bin | Treteimer  
 Dimensions H 25,5 cm, T 24 cm, Ø 20 cm, V 3 l  
 Materials K3, K4  
 Colour White  
 Features Soft Close



66327  
White



66325  
Micro Chip



66328  
Black



66324  
Moonbeam



66322  
Satellite



66323  
Magnet



66897 - NEW  
Amber Brown



66382  
Tan



67552 - NEW  
Mazarine Blue



**VIPO 66313**

Shower Squeegee, includes overdoor hook |  
 Duschwischer, mit Halter  
 Dimensions H 20 cm, B 25 cm, T 2,5 cm  
 Materials K4  
 Colour White



66313  
White



69202  
Micro Chip



66314  
Black



69201  
Moonbeam



69200  
Satellite



68982  
Magnet



66349  
Tan



**SONO 66281**

Toilet Brush | WC-Bürste  
 Dimensions H 39 cm, Ø 11 cm  
 Materials SSp, ST2, K3, K4  
 Colour White



66281  
White



69064  
Micro Chip



66282  
Black



69055  
Moonbeam



69047  
Satellite



69040  
Magnet



66896 - NEW  
Amber Brown



66378  
Tan



67551 - NEW  
Mazarine Blue



**SONO 66284**

Pedal Bin | Treteimer  
 Dimensions H 30,5 cm, T 29,5 cm, Ø 24 cm, V 5 l  
 Materials K3, K4  
 Colour White  
 Features Soft Close



66284  
White



69170  
Micro Chip



66285  
Black



69169  
Moonbeam



69168  
Satellite



69167  
Magnet



66380  
Tan





**KIREI 66862**

Glass Bottle | Glasflasche  
 Dimensions H 15 cm, Ø 8 cm, V 350 ml  
 Materials Gs, K3, Sb  
 Colour White - Conditioner  
 Features Incl. Wall Mounting Accessories and Glue Kit | Inkl. Wandhalterung und Klebeset

NEW



**66862**  
White - Conditioner

**66864**  
White - Shampoo

**66866**  
White - Shower Gel

**66870**  
Smoke - Conditioner

**66872**  
Smoke - Shampoo

**66874**  
Smoke - Shower Gel

**KIREI 66863**

Glass Bottle | Glasflasche  
 Dimensions H 15 cm, Ø 8 cm, V 350 ml  
 Materials Gs, K3, Sb  
 Colour White - Conditioner  
 Features Incl. Wall Mounting Accessories, screws and dowels  
 Inkl. Wandhalterung, Schrauben und Dübel

NEW



**66863**

White - Conditioner

**66865**

White - Shampoo

**66867**

White - Shower Gel

**66871**

Smoke - Conditioner

**66873**

Smoke - Shampoo

**66875**

Smoke - Shower Gel

**KIREI GLASS BOTTLES**

KIREI glass bottles are durable companions for shampoo, shower gel and conditioner. Robust, reusable and stylish – whether free-standing or in a matt black wall bracket. KIREI reduces plastic waste and brings order and elegance to the bathroom.

**KIREI GLASFLASCHEN**

Die KIREI Glasflaschen sind langlebige Begleiter für Shampoo, Duschgel und Conditioner. Robust, wiederverwendbar und stilvoll – ob freistehend oder in einer mattschwarzen Wandhalterung. KIREI reduziert Plastikmüll und bringt Ordnung und Eleganz ins Bad.

**KIREI 66868**

Set of 3 Glass Bottles | Set 3 Glasflaschen  
 Dimensions H 15 cm, Ø 8 cm, V 350 ml  
 Materials Gs, K3, Sb  
 Colour White  
 Features Incl. Wall Mounting Accessories and Glue Kit  
 Inkl. Wandhalterung und Klebeset

NEW



**66868**  
White



**66876**  
Smoke



**KIREI 66869**

Set of 3 Glass Bottles | Set 3 Glasflaschen  
 Dimensions H 15 cm, Ø 8 cm, V 350 ml  
 Materials Gs, K3, Sb  
 Colour White  
 Features Incl. Wall Mounting Accessories, screws and dowels  
 Inkl. Wandhalterung, Schrauben und Dübel

NEW



**66869**  
White



**66877**  
Smoke



**ROF 67399**

Set of 2 Wall Hooks | Set 2 Wandhaken  
 Dimensions H 3 cm, Ø 3 cm  
 Materials Sb  
 Colour Black  
 Features Incl. Mounting accessories  
 Inkl. Montagematerial



67399 - NEW  
White



66881  
Black



66882  
Silver



66883  
Burned Metal



66884  
Brass

**ROF 67400**

Set of 2 Wall Hooks | Set 2 Wandhaken  
 Dimensions H 4 cm, T 3,5 cm, Ø 1 cm  
 Materials Sb  
 Colour White  
 Features Incl. Mounting accessories  
 Inkl. Montagematerial



67400 - NEW  
White



66885  
Black



66886  
Silver



66887  
Burned Metal



66888  
Brass

**ROF – WALL HOOKS WITH KNURLED CRAFTSMANSHIP**

Perfection is when a symbiosis of design and functionality occurs – just like with the ROF wall hooks. The production step of refining the metal with diamond knurling does not only give it a striking appearance, it also ensures that the surface has an improved grip and is also more robust against scratches and wear. The knurling is perfect in both classic and contemporary furnishings. Whether in the hallway, bedroom, bathroom or kitchen – our knurled wall hooks are versatile and help you bring order and style to any room. Use them for towels, kitchen utensils, keys or as a decorative element, such as a furniture handle to add a tactile touch to your cupboards and dressers.

**ROF – WANDHAKEN IN GERÄNDELTER HANDWERKSKUNST**

Perfektion ist, wenn eine Symbiose aus Design und Funktionalität eintritt – genau wie bei den ROF Wandhaken. Das in Diamant-Rändelung veredelte Metall erhält durch diesen Arbeitsschritt nicht nur seine markante Optik, es sorgt auch dafür, dass die Oberfläche eine verbesserte Griffbarkeit bekommt und zudem robuster gegenüber Kratzern und Abnutzungen ist. Die Rändelung kommt sowohl in klassischer, als auch zeitgenössischer Einrichtung perfekt zur Geltung. Ob im Flur, Schlafzimmer, Badezimmer oder in der Küche – unsere gerändelten Wandhaken sind vielseitig einsetzbar und helfen Ihnen, Ordnung und Stil in jeden Raum zu bringen. Nutzen Sie sie für Handtücher, Küchenutensilien, Schlüssel oder als dekoratives Element, beispielsweise als Handgriff für Möbel, mit dem Sie Ihren Schränken und Kommoden eine taktile Note verleihen.





**KAPI 67232**

Wiper with Wall Hook |  
 Duschwischer mit Wandhalterung  
 Dimensions H 11 cm, B 27 cm, T 0,5 cm  
 Materials K4  
 Colour Moonbeam



67232  
Moonbeam



67233  
Magnet



67234  
Black

**KAPI – STREAK-FREE AND ALWAYS TO HAND**

Nothing is as inviting as a clean home where you can feel at rest. The same applies to a bathroom, where you can not only freshen up for the day, but also spend relaxing hours in your stressful everyday life. With the KAPI shower wiper, you can clean your bathroom surfaces effortlessly and without streaks after showering. Available in the three colours Moonbeam, Magnet and Black, it blends in perfectly with your bathroom. The practical suction cup allows you to hang the shower squeegee wherever you need it within easy reach.

**KAPI – STREIFENFREI UND IMMER ZUR HAND**

Nichts ist so einladend wie eine saubere Wohnung, in der man sich zuhause fühlen kann. Genauso ist es bei einem Badezimmer, in dem Sie sich nicht nur frisch für den Tag machen, sondern auch entspannende Stunden im stressigen Alltag verbringen können. Mit dem KAPI Duschwischer reinigen Sie Ihre Badflächen nach dem Duschen streifenfrei und mühelos. In den drei Farben Moonbeam, Magnet und Black fügt er sich ideal in Ihr Badezimmer ein. Der praktische Saugnapf ermöglicht es, den Duschwischer überall aufzuhängen, wo Sie ihn griffbereit benötigen.

**FLIT 65257**

Wiper | Duschwischer  
 Dimensions H 23 cm, B 7 cm, T 0,5 cm  
 Materials K4  
 Colour Moonbeam



65257  
Moonbeam



65258  
Magnet



65259  
Black



**FERA 69078**

Towel Ladder | Handtuchleiter  
 Dimensions H 165 cm, B 45 cm  
 Materials Sb

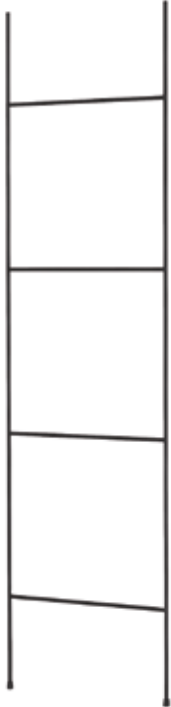

**LAVEA 68990**

Wiper | Bodenwischer  
 Dimensions H 122 cm, B 36 cm, T 2 cm  
 Materials SSp, K4, K3  
 Features Includes wall bracket  
 Mit Wandhalterung



**MENOTO 68664**

Towel Stand | Handtuchständer  
 Dimensions H 86 cm, B 50 cm, T 16 cm  
 Materials SSp, ST3



**LAVEA 68846**

Shower Squeegee, includes overdoor hook |  
 Duschwischer, mit Halter  
 Dimensions H 3,5 cm, B 27 cm, T 22 cm  
 Materials SSp, K4



**MENOTO 68624**

Towel Stand | Handtuchständer  
 Dimensions H 86 cm, B 50 cm, T 16 cm  
 Materials SSm, ST3



**MENOTO 69150**

Towel Stand | Handtuchständer  
 Dimensions H 86 cm, B 50 cm, T 16 cm  
 Materials SSb, ST3  
 Colour Black







**MENOTO 66310**

Towel Rack | Handtuchständer  
 Dimensions H 90 cm, B 75 cm, T 16 cm  
 Materials SSb, ST3  
 Colour Black

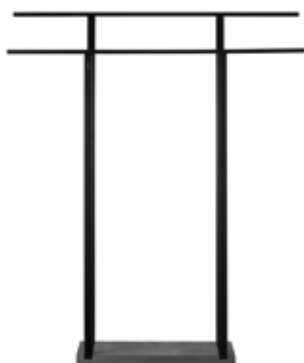

**MENOTO 69151**

Toilet Paper Holder and Brush | Toilettenbutler  
 Dimensions H 64,5 cm, B 15 cm, T 20 cm  
 Materials Sb, ST3  
 Colour Black



**MENOTO 66311**

Toilet Paper Holder and Brush | Toilettenbutler  
 Dimensions H 72,5 cm x B 15 cm x T 20 cm  
 Materials SSb, ST3  
 Colour Black



## BATH ESSENTIALS

### MENOTO 68688

Toilet Paper Holder and Brush | Toilettenbutler  
Dimensions H 64,5 cm, B 15 cm, T 20 cm  
Materials SSp, ST3



### MENOTO 68663

Toilet Paper Holder and Brush | Toilettenbutler  
Dimensions H 72,5 cm, B 15 cm, T 20 cm  
Materials SSp, ST3



### MENOTO 68623

Toilet Paper Holder and Brush | Toilettenbutler  
Dimensions H 72,5 cm, B 15 cm, T 20 cm  
Materials SSm, ST3



### MENOTO 68687

Toilet Paper Holder and Brush | Toilettenbutler  
Dimensions H 64,5 cm, B 15 cm, T 20 cm  
Materials SSm, ST3



### MENOTO 68820

Toilet Paper Holder and Brush | Toilettenbutler  
Dimensions H 64,5 cm, B 15 cm, T 20 cm  
Materials SSp, ST3, K3



### MENOTO 68819

Toilet Paper Holder and Brush | Toilettenbutler  
Dimensions H 64,5 cm, B 15 cm, T 20 cm  
Materials SSm, ST3, K3



**METIA 88092**

Replacement Brush | Ersatzbürste  
 Materials K3  
 Features For/Passend für: CRETO, MENOTO,  
 MODO, NEXIO, SONO



**VISTA 68949**

Vanity Mirror | Kosmetikspiegel  
 Dimensions H 29 cm, B 11 cm, T 14 cm  
 Materials Sc  
 Features Rotatable, 5 time magnifying  
 Mit beweglicher Spiegelfläche, 5-fach  
 Vergrößerung



**VISTA 68948**

Vanity Mirror | Kosmetikspiegel  
 Dimensions H 29 cm, B 11 cm, T 14 cm  
 Materials Sn  
 Features Rotatable, 5 time magnifying  
 Mit beweglicher Spiegelfläche, 5-fach  
 Vergrößerung



**METIA 88133**

Replacement Brush | Ersatzbürste  
 Materials K3  
 Features For/Passend für: ARA, MENOTO,  
 NEXIO



**MENOTO 68880**

Wall Hook | Wandhaken  
 Dimensions H 6 cm, B 6 cm, T 2,5 cm  
 Materials SSp  
 Features Self-adhesive  
 Selbstklebend



**MENOTO 68839**

Wall Hook | Wandhaken  
 Dimensions H 6 cm, B 6 cm, T 2,5 cm  
 Materials SSm  
 Features Self-adhesive  
 Selbstklebend



**MEDA 31056**

Metal-Fluid, 100 ml | Metal-Fluid, V 100 ml

Highly effective metal fluid MEDA for care, protection and cleaning of matt and polished metal surfaces indoors, such as stainless steel, aluminum, chrome as well as ceramics, wood, glass and plastics. NSF registered.

Hochwirksames Metal-Fluid MEDA für Pflege, Schutz und Reinigung von matten und polierten Metalloberflächen im Innenbereich, wie Edelstahl, Aluminium, Chrom sowie Keramik, Holz, Glas und Kunststoffe. NSF-registriert.



**NEXIO 68915**

Glass Shower Overdoor Hook |  
 Haken für Glasduschwand  
 Dimensions H 14 cm, B 4 cm, T 3,5 cm  
 Materials SSp, K3, K4  
 Features Fits glass gauges of 6-8 mm  
 Passend für 6-8 mm starke  
 Glaswände



**NEXIO 68905**

Glass Shower Overdoor Hook |  
 Haken für Glasduschwand  
 Dimensions H 14 cm, B 4 cm, T 3,5 cm  
 Materials SSm, K3, K4  
 Features Fits glass gauges of 6-8 mm  
 Passend für 6-8 mm starke  
 Glaswände





**TUUFA 67568**

Bathmat | Badematte  
 Dimensions B 60 cm, T 60 cm  
 Materials T3  
 Colour Moonbeam  
 Features 2200 g/m<sup>2</sup>, anti slip backside  
 2200 g/m<sup>2</sup>, Antirutsch Rückseite

NEW



**TUUFA 67569**

Bathmat | Badematte  
 Dimensions B 60 cm, T 60 cm  
 Materials T3  
 Colour Satellite  
 Features 2200 g/m<sup>2</sup>, anti slip backside  
 2200 g/m<sup>2</sup>, Antirutsch Rückseite

NEW



**TUUFA 67570**

Bathmat | Badematte  
 Dimensions B 60 cm, T 60 cm  
 Materials T3  
 Colour Magnet  
 Features 2200 g/m<sup>2</sup>, anti slip backside  
 2200 g/m<sup>2</sup>, Antirutsch Rückseite

NEW



**TUUFA 67571**

Bathmat | Badematte  
 Dimensions B 70 cm, T 140 cm  
 Materials T3  
 Colour Moonbeam  
 Features 2200 g/m<sup>2</sup>, anti slip backside  
 2200 g/m<sup>2</sup>, Antirutsch Rückseite

NEW



**TUUFA 67572**

Bathmat | Badematte  
 Dimensions B 70 cm, T 140 cm  
 Materials T3  
 Colour Satellite  
 Features 2200 g/m<sup>2</sup>, anti slip backside  
 2200 g/m<sup>2</sup>, Antirutsch Rückseite

NEW



**TUUFA 67573**

Bathmat | Badematte  
 Dimensions B 70 cm, T 140 cm  
 Materials T3  
 Colour Magnet  
 Features 2200 g/m<sup>2</sup>, anti slip backside  
 2200 g/m<sup>2</sup>, Antirutsch Rückseite

NEW



**TUUFA BATHMAT**

Soft as a carpet, gentle as a ritual: TUUFA bathmats bring warmth and comfort to the bathroom. Their dense, velvety pile invites your feet to linger, while the non-slip backing provides safety. Easy to care for and quick-drying, they combine comfort with everyday practicality – a touch of well-being in every bathroom.

**TUUFA BADEMATTE**

Weich wie ein Teppich, sanft wie ein Ritual: Die TUUFA Badematten bringen Wärme und Geborgenheit ins Badezimmer. Ihr dichter, samtiger Flor lädt die Füße zum Verweilen ein, während die rutschhemmende Rückseite Sicherheit schenkt. Pflegeleicht und schnelltrocknend verbinden sie Komfort mit Alltagstauglichkeit – ein Stück Wohlgefühl in jedem Bad.



## BATH ESSENTIALS

### TUYO BATHMAT

Give your bathroom that extra touch with the TUYO bath mat, made from 100% Turkish cotton. With a weight of 1000g/m<sup>2</sup>, the TUYO bath mat, manufactured in Turkey and GOTS certified, offers a particularly soft and absorbent surface that is pure pampering for your feet.

Choose from the three stylish blomus colours Moonbeam, Satellite and Magnet to perfectly round off the ambience of your bathroom. Thanks to the two practical sizes TUYO fits seamlessly into any bathroom.

### TUYO BADEMATTE

Verleihen Sie Ihrem Badezimmer das gewisse Extra mit der TUYO Badematte, hergestellt aus 100% türkischer Baumwolle. Mit ihrem Gewicht von 1000g/m<sup>2</sup> bietet die in der Türkei gefertigte und GOTS zertifizierte TUYO Badematte eine besonders weiche und saugfähige Oberfläche, die pure Verwöhnung für Ihre Füße bedeutet.

Wählen Sie aus den drei stilvollen blomus-Farben Moonbeam, Satellite und Magnet, um das Ambiente Ihres Badezimmers perfekt abzurunden. Dank der zwei praktischen Größen fügt sich TUYO nahtlos in jedes Badezimmer ein.



#### TUYO 67333

Bathmat | Badematte

Dimensions B 60 cm, T 60 cm

Materials T1

Colour Moonbeam

Features 100% Organic Cotton,  
1000 g/m<sup>2</sup>  
100% Bio-Baumwolle,  
1000 g/m<sup>2</sup>

67333  
Moonbeam



67332  
Satellite



67331  
Magnet



#### TUYO 67336

Bathmat | Badematte

Dimensions B 100 cm, T 60 cm

Materials T1

Colour Moonbeam

Features 100% Organic Cotton,  
1000 g/m<sup>2</sup>  
100% Bio-Baumwolle,  
1000 g/m<sup>2</sup>

67336  
Moonbeam



67335  
Satellite



67334  
Magnet





**KAAVU 67327**

Bathmat | Badematte  
 Dimensions B 80 cm, T 50 cm  
 Materials T1  
 Colour Moonbeam  
 Features 100% Organic Cotton,  
 1500 g/m<sup>2</sup>  
 100% Bio-Baumwolle,  
 1500 g/m<sup>2</sup>



67327  
Moonbeam



67326  
Satellite



67325  
Magnet



**KAAVU 67330**

Bathmat | Badematte  
 Dimensions B 100 cm, T 60 cm  
 Materials T1  
 Colour Moonbeam  
 Features 100% Organic Cotton,  
 1500 g/m<sup>2</sup>  
 100% Bio-Baumwolle,  
 1500 g/m<sup>2</sup>



67330  
Moonbeam



67329  
Satellite



67328  
Magnet



**KAAVU BATHMAT**

Whether lying in front of the washbasin, bathtub or shower, the KAAVU bath mat gives your feet the ultimate spa feeling thanks to the high-quality 1500 g/m<sup>2</sup> GOTS cotton quality. Made in Turkey, the bath mat is available in two different sizes and is extremely soft and absorbent.

**KAAVU BADEMATTE**

Sei es vor dem Waschbecken, der Badewanne oder der Dusche liegend, die KAAVU Badematte verleiht Ihren Füßen durch die hochwertige 1500 g/m<sup>2</sup> schwere GOTS Baumwollqualität das ultimative Spa-Gefühl. Die in der Türkei hergestellte Badematte ist in zwei verschiedene Größen erhältlich und überzeugt durch höchste Weichheit und Saugfähigkeit.



97.T.1068  
HOHENSTEIN HTTI







**ARTO 67337**

Bath Towel | Badetuch  
 Dimensions B 70 cm, T 140 cm  
 Materials T1 (ORGANIC)  
 Colour Moonbeam/Magnet  
 Features 100% Organic Cotton, Terry Cloth,  
 600g/m<sup>2</sup> | 100% Bio-Baumwolle,  
 Frottee 600 g/m<sup>2</sup>



**67337**  
 Moonbeam/Magnet



**67339**  
 Moonbeam/Amber Brown



**67341**  
 Micro Chip/Tan



**67343**  
 Desert Sage/Agave Green



**67427 - NEW**  
 Moonbeam/Mazarine Blue



**67425 - NEW**  
 White/Transparent Yellow



**67338**  
 Moonbeam/Magnet



**67340**  
 Moonbeam/Amber Brown



**67342**  
 Micro Chip/Tan



**67344**  
 Desert Sage/Agave Green



**67428 - NEW**  
 Moonbeam/Mazarine Blue



**67426 - NEW**  
 White/Transparent Yellow

**ARTO 67580**

Towel | Handtuch  
 Dimensions B 50 cm, T 100 cm  
 Materials T1 (ORGANIC)  
 Colour Moonbeam/Magnet  
 Features 100 % Organic Cotton, Terry Cloth, 600g/m<sup>2</sup> | 100 % Bio-Baumwolle, Frottee 600 g/m<sup>2</sup>



67580 - NEW  
Moonbeam/Magnet



67431 - NEW  
Moonbeam/Mazarine Blue



67429 - NEW  
White/Transparent Yellow



67345  
Moonbeam/Magnet



67346  
Moonbeam/Amber Brown



67347  
Micro Chip/Tan



67348  
Desert Sage/Agave Green



67432 - NEW  
Moonbeam/Mazarine Blue



67430 - NEW  
White/Transparent Yellow



**ARTO 67581**

Set of 2 Guest Hand Towel | Set 2 Gästehandtücher  
 Dimensions B 30 cm, T 50 cm  
 Materials T1 (ORGANIC)  
 Colour Moonbeam/Magnet  
 Features 100 % Organic Cotton, Terry Cloth, 600g/m<sup>2</sup> | 100 % Bio-Baumwolle, Frottee 600 g/m<sup>2</sup>



67581 - NEW  
Moonbeam/Magnet



67435 - NEW  
Moonbeam/Mazarine Blue



67434 - NEW  
White/Transparent Yellow



67349  
Moonbeam/Magnet



67350  
Moonbeam/Amber Brown



67351  
Micro Chip/Tan



67352  
Desert Sage/Agave Green



67436 - NEW  
Moonbeam/Mazarine Blue



67433 - NEW  
White/Transparent Yellow



**ARTO – STRIPED TOWELS**

The ARTO towels bring colour to your bathroom. While the striped design sets colourful accents, the basic colours of the ARTO series perfectly match the existing blomus RIVA series and guarantee a perfect match between the two series.

Manufactured in Turkey, the GOTS-certified 600 g/m<sup>2</sup> cotton terry towels are available as guest towels in a set, as a hand towel or bath towel.

**ARTO – GESTREIFTE HANDTÜCHER**

Die ARTO Handtücher bringen Farbe in Ihr Badezimmer. Während das Streifendesign farbliche Akzente setzt, passen sich die Grundfarben der ARTO Serie perfekt an die bereits bestehende blomus RIVA Serie an und garantieren ein Perfect Match der beiden Serien.

Die in der Türkei gefertigten, GOTS-zertifizierten, 600 g/m<sup>2</sup> Baumwoll-Frotteehandtücher sind als Gästehandtücher im Set, als Handtuch oder Badetuch erhältlich.



# BATH ESSENTIALS

## RIVA 66298

Sauna Towel | Sauna Handtuch  
 Dimensions B 100 cm, T 200 cm  
 Materials T1 (ORGANIC)  
 Colour White  
 Features 100% Organic Cotton, Terry Cloth  
 700g/m<sup>2</sup> | 100% Bio-Baumwolle,  
 Frottee 700 g/m<sup>2</sup>

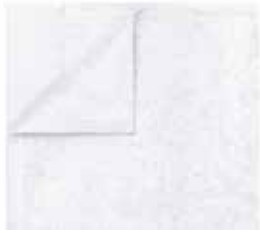

66298  
White



69251  
Micro Chip



66303  
Black



69249  
Moonbeam



69250  
Satellite



69248  
Magnet



66400  
Tan



97.T.1068  
HOHENSTEIN HTTI



organic  
Certified by KIWA BCS  
35020

## RIVA 66294

Bath Towel | Badetuch  
 Dimensions B 70 cm, T 140 cm  
 Materials T1 (ORGANIC)  
 Colour White  
 Features 100% Organic Cotton, Terry Cloth  
 700g/m<sup>2</sup> | 100% Bio-Baumwolle,  
 Frottee 700 g/m<sup>2</sup>



66294  
White



69121  
Satellite



66299  
Black



69120  
Moonbeam



69122  
Micro Chip



69119  
Magnet



66396  
Tan



97.T.1068  
HOHENSTEIN HTTI



organic  
Certified by KIWA BCS  
35020

## RIVA 66295

Hand Towel | Handtuch  
 Dimensions B 50 cm, T 100 cm  
 Materials T1 (ORGANIC)  
 Colour White  
 Features 100% Organic Cotton, Terry Cloth  
 700g/m<sup>2</sup> | 100% Bio-Baumwolle,  
 Frottee 700 g/m<sup>2</sup>



66295  
White



69126  
Satellite



66300  
Black



69125  
Moonbeam



69127  
Micro Chip



69124  
Magnet



66397  
Tan



97.T.1068  
HOHENSTEIN HTTI



organic  
Certified by KIWA BCS  
35020

**RIVA 66296**

Set of 2 Guest Hand Towels | Set 2 Gästehandtücher

Dimensions B 30 cm, T 50 cm

Materials T1 (ORGANIC)

Colour White

Features 100% Organic Cotton,  
Terry Cloth 700g/m<sup>2</sup>  
100% Bio-Baumwolle,  
Frottee 700 g/m<sup>2</sup>



66296  
White



69241  
Micro Chip



66301  
Black



69239  
Moonbeam



69240  
Satellite



69238  
Magnet



66398  
Tan



97.T.1068  
HOHENSTEIN HTTI



**RIVA 66297**

Set of 4 Guest Hand Towels | Set 4 Gästehandtücher

Dimensions B 30 cm, T 30 cm

Materials T1 (ORGANIC)

Colour White

Features 100% Organic Cotton,  
Terry Cloth 700g/m<sup>2</sup>  
100% Bio-Baumwolle,  
Frottee 700 g/m<sup>2</sup>



66297  
White



69132  
Micro Chip



66302  
Black



69130  
Moonbeam



69131  
Satellite



69129  
Magnet



66399  
Tan



97.T.1068  
HOHENSTEIN HTTI



**700 G/M<sup>2</sup> TERRY – 100% ORGANIC COTTON**

Our terry towels meet the highest standards of comfort and quality. The cloth gives an exclusive feeling on your body. GOTS, the Global Organic Textile Standard (GOTS) is the world's leading standard for textiles made from organic fibres. It specifies high-level environmental criteria throughout the entire organic textiles supply chain, and stipulates compliance with social criteria as well. Choosing a GOTS-certified product is your way to respect and protect the environment, and the people involved in organic textile production.

OEKO-TEX® is your guarantee that every component of a textile article (i.e., every thread, button, zip, and any other accessories) has been tested for harmful substances, and that the article is harmless to use. The test is conducted by independent OEKO-TEX® partner institutes, in accordance with extensive criteria for safety and health. OEKO-TEX® enables consumers and companies to make responsible decisions, and reduces the use of harmful substances in textile production.

**700 G/M<sup>2</sup> FROTTEE – 100% BIO - BAUMWOLLE**

Unsere Frotteetücher erfüllen die höchsten Ansprüche an Komfort und Qualität. Das Tuch verleiht ein exklusives Gefühl auf Ihrem Körper.

GOTS. Der Global Organic Textile Standard (GOTS) ist als weltweit führender Standard für die Verarbeitung von Textilien aus biologisch erzeugten Naturfasern anerkannt. Auf hohem Niveau definiert er umwelttechnische Anforderungen entlang der gesamten textilen Produktionskette und fordert gleichzeitig die Einhaltung von Sozialkriterien. Wenn Sie sich für ein GOTS-zertifiziertes Produkt entscheiden, respektieren und schützen Sie die Umwelt und die Menschen, die an der ökologischen Textilproduktion beteiligt sind.

OEKO-TEX® ist Ihre Garantie dafür, dass jede Komponente eines Textilartikels (d.h. jeder Faden, Knopf und sonstige Accessoires) auf Schadstoffe geprüft wurden und der Artikel somit humanökologisch unbedenklich ist. Die Prüfung wird von unabhängigen OEKO-TEX® Instituten nach umfangreichen Kriterien für Sicherheit und Gesundheit durchgeführt. OEKO-TEX® ermöglicht Verbrauchern und Unternehmen, verantwortungsvolle Entscheidungen zu treffen, und reduziert den Einsatz schädlicher Substanzen in der Textilproduktion.



**FRINO – ORGANIC COTTON TOWELS**

The Organic cotton towels come in different colours so you can find the perfect match with your other blomus bathroom accessories. The playful fringes are a happy addition to the existing towel ranges. The 500 gs/sqm heavy cotton terry towels are GOTS-certified and washable at 60 °C.

**FRINO - BIO-BAUMWOLLHANDTÜCHER**

Die Handtücher aus Bio-Baumwolle sind in verschiedenen Farben erhältlich, sodass Sie perfekt mit Ihren anderen blomus Bad-Accessoires kombiniert werden können. Die verspielten Fransen sind eine fröhliche Ergänzung zu den bestehenden Handtuchserien. Die 500 g/qm schweren Baumwoll-Frottierhandtücher sind GOTS-zertifiziert und bei 60 °C waschbar.



**FRINO 66490**

Set of 2 Guest Hand Towels | Set 2 Gästehandtücher  
 Dimensions B 30 cm, T 50 cm  
 Materials T1 (ORGANIC)  
 Colour White  
 Features Organic Cotton, Terry Cloth 500 g/m<sup>2</sup>  
 Bio-Baumwolle, Frottee 500 g/m<sup>2</sup>



66490  
White



66487  
Micro Chip



66493  
Black



66481  
Moonbeam



66478  
Satellite



66484  
Magnet



66499  
Tan



**FRINO 66489**

Hand Towel | Handtuch  
 Dimensions B 50 cm, T 100 cm  
 Materials T1 (ORGANIC)  
 Colour White  
 Features 100% Organic Cotton, Terry Cloth  
 500g/m<sup>2</sup> | 100% Bio-Baumwolle,  
 Frottee 500 g/m<sup>2</sup>



66489  
White



66486  
Micro Chip



66492  
Black



66480  
Moonbeam



66477  
Satellite



66483  
Magnet



66498  
Tan



**FRINO 66488**

Bath towel | Badetuch  
 Dimensions B 70 cm, T 140 cm  
 Materials T1 (ORGANIC)  
 Colour White  
 Features 100% Organic Cotton, Terry Cloth  
 500g/m<sup>2</sup> | 100% Bio-Baumwolle,  
 Frottee 500 g/m<sup>2</sup>



66488  
White



66485  
Micro Chip



66491  
Black



66479  
Moonbeam



66476  
Satellite



66482  
Magnet



66497  
Tan



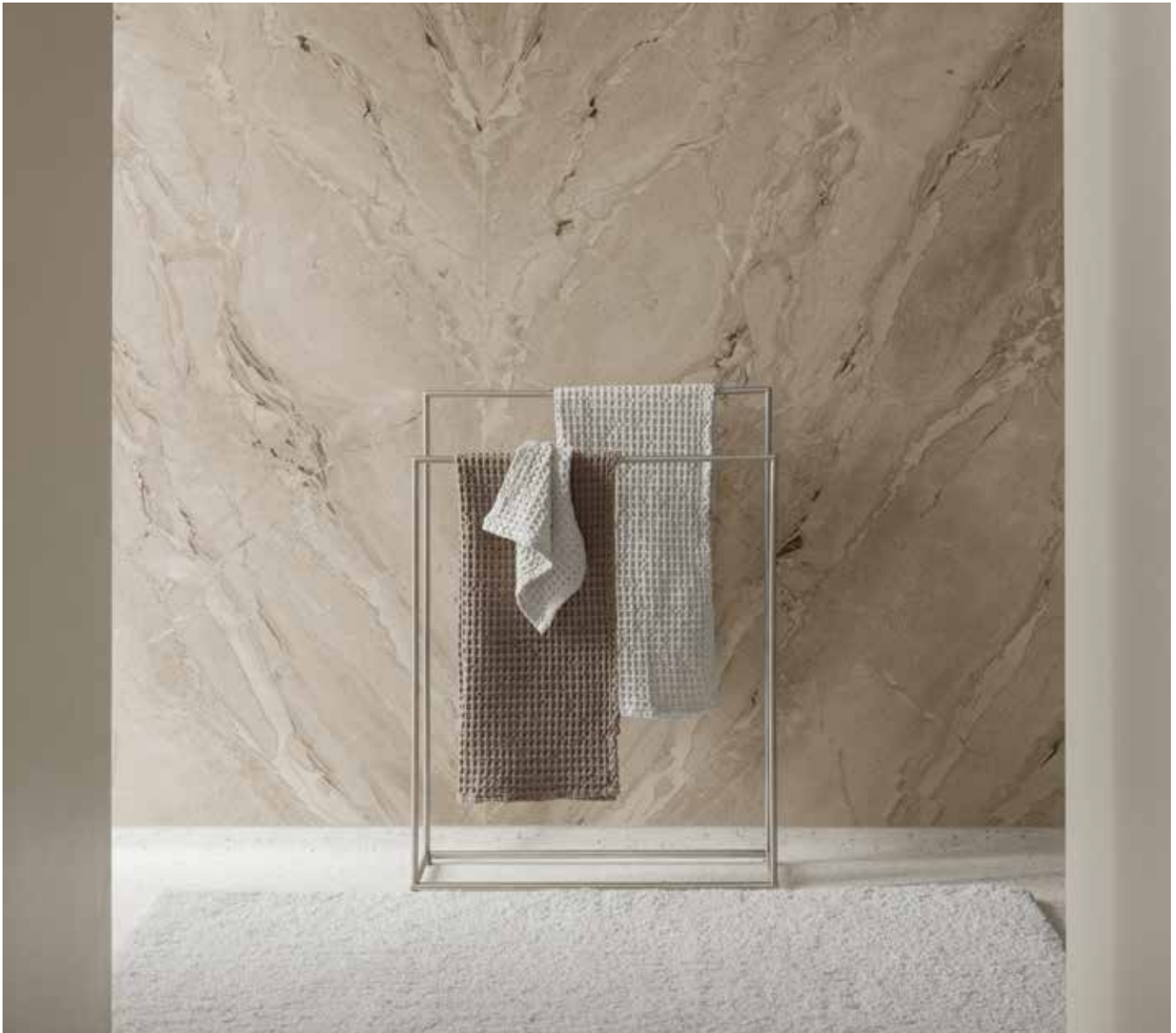

**CARO COTTON - STANDARD 100 BY OEKO-TEX®**

Cotton is an extremely absorbent, tear-resistant seed fibre used for textiles because of its many unique qualities. Cotton is boil-proof, which secures maximum hygiene. OEKO-TEX® is your guarantee that every component of a textile article (i.e., every thread, button, zip, and any other accessories) has been tested for harmful substances, and that the article is harmless to use. The test is conducted by independent OEKO-TEX® partner institutes, in accordance with extensive criteria for safety and health. OEKO-TEX® enables consumers and companies to make responsible decisions, and reduces the use of harmful substances in textile production.

**CARE**

Please observe the care instructions on the product.

**CARO BAUMWOLLE - STANDARD 100 BY OEKO-TEX®**

Baumwolle ist eine extrem saugfähige, reißfeste Samenfaser, die aufgrund ihrer sehr vielfältigen Qualitäten für die Textilherstellung eingesetzt wird. Baumwolle ist kochfest, was eine maximale Hygiene bedeutet. OEKO-TEX® ist Ihre Garantie dafür, dass jede Komponente eines Textilartikels (d.h. jeder Faden, Knopf und sonstige Accessoires) auf Schadstoffe geprüft wurden und der Artikel somit humanökologisch unbedenklich ist. Die Prüfung wird von unabhängigen OEKO-TEX® Instituten nach umfangreichen Kriterien für Sicherheit und Gesundheit durchgeführt. OEKO-TEX® ermöglicht Verbrauchern und Unternehmen, verantwortungsvolle Entscheidungen zu treffen, und reduziert den Einsatz schädlicher Substanzen in der Textilproduktion.

**PFLEGE**

Bitte die Pflegehinweise am Produkt beachten.



**CARO 66304**

Bath Towel | Badetuch  
 Dimensions B 70 cm, T 140 cm  
 Materials T1  
 Colour White  
 Features Waffle pattern | Waffelpiqué - 400 g/m<sup>2</sup>  
 STANDARD 100 by OEKO-TEX®



**CARO 66305**

Hand Towel | Handtuch  
 Dimensions B 50 cm, T 100 cm  
 Materials T1  
 Colour White  
 Features Waffle pattern | Waffelpiqué - 400 g/m<sup>2</sup>  
 STANDARD 100 by OEKO-TEX®



**CARO 66306**

Set of 2 Guest Hand Towels | Set 2 Gästehandtücher  
 Dimensions B 30 cm, T 30 cm  
 Materials T1  
 Colour White  
 Features Waffle pattern | Waffelpiqué - 400 g/m<sup>2</sup>  
 STANDARD 100 by OEKO-TEX®



## BATH ESSENTIALS

### SAHLA LAUNDRY BASKET

SAHLA, Samoan for 'simple and discreet', epitomises a laundry collector that is as discreet as it is special. The classic cylindrical shape blends with the soft faux suede cover to create a sophisticated eye-catcher. The lid with handle closes the basket and awards it with a special elegance. Storing laundry has never been so stylish and exclusive at the same time.

### SAHLA WÄSCHESAMMLER

SAHLA, samoanisch für einfach und dezent, verkörpert einen Wäschesammler, der ebenso dezent wie auch besonders ist. Die klassisch zylindrische Form verschmilzt mit dem weichen Kunst-Wildlederbezug zu einem edlen Hingucker. Der Deckel mit Griff verschließt den Korb und verleiht ihm eine besondere Eleganz. Nie war die Aufbewahrung von Wäsche so stilvoll und elegant zugleich.



### SAHLA 67226

Laundry Basket | Wäschesammler  
 Dimensions H 51 cm, Ø 35 cm, V 50 l  
 Materials T10  
 Colour Nomad  
 Features: Size: M



67226  
Nomad



67228  
Pewter



68360 - NEW  
Black



67227  
Indian Tan



### SAHLA 67229

Laundry Basket | Wäschesammler  
 Dimensions H 54 cm, Ø 40 cm, V 67,5 l  
 Materials T10  
 Colour Nomad  
 Features: Size: L



67229  
Nomad



67231  
Pewter



68361 - NEW  
Black



67230  
Indian Tan



**KORIE LAUNDRY BASKET**

The KORIE laundry basket enriches your home in several ways. Not only is it modern and decorative, it also makes your clutter disappear and leaves nothing behind but a stylish eye-catcher.

Made from durable and easy-care plastic, the basket has a lid with an opening, making it ideal for use as a laundry basket. The lid can be removed to empty it. The two handles and the basket's low weight also make it easy to take the basket with you wherever you go.

**KORIE WÄSCHESAMMLER**

Der KORIE Wäschekorb bereichert gleich in mehreren Hinsichten Ihr Zuhause. Er ist nicht nur modern und dekorativ, er lässt außerdem Ihre Unordnung verschwinden und lässt nichts als einen stylischen Hingucker zurück.

Der Korb aus langlebigem und pflegeleichtem Kunststoff verfügt über einen Deckel, der eine Öffnung hat und sich damit ideal als Wäschekorb eignet. Um ihn zu entleeren kann der Deckel abgenommen werden. Die beiden Griffe und das geringe Gewicht des Korbes ermöglichen es außerdem, den Korb beliebig mitzunehmen.



**KORIE 65481**

Laundry Basket | Wäschесammler  
 Dimensions H 55 cm, Ø 40 cm  
 Materials K3  
 Colour White



65481  
White



65479  
Moonbeam



65480  
Magnet



66878 - NEW  
Amber Brown



66879 - NEW  
Mazarine Blue



**SAHLA 68314**

Tissue Box | Kosmetiktuchbox  
 Dimensions H 9,5 cm, B 25 cm, T 13 cm  
 Materials T10  
 Colour Nomad



**68314**  
Nomad



**68316**  
Pewter



**68315**  
Indian Tan

**SAHLA 68317**

Tissue Bag | Kosmetiktuchtasche  
 Dimensions H 9,5 cm, B 25 cm, T 13 cm  
 Materials T10  
 Colour Nomad



**68317**  
Nomad



**68319**  
Pewter



**68318**  
Indian Tan



**SAHLA 68320**

Jewelry Box | Schmuckaufbewahrung  
 Dimensions H 4 cm, B 22 cm, T 15,5 cm  
 Materials T10  
 Colour Nomad



**68320**  
Nomad



**68322**  
Pewter



**68321**  
Indian Tan

**SAHLA 68323**

Jewelry Box | Schmuckaufbewahrung  
 Dimensions H 10 cm, B 22 cm, T 15,5 cm  
 Materials T10  
 Colour Nomad



**68323**  
Nomad



**68325**  
Pewter



**68324**  
Indian Tan

**NEXIO 66312**

Tissue Dispenser | Papiertuchspender  
 Dimensions H 30 cm, B 27 cm, T 13 cm  
 Materials SSb  
 Colour Black



**NEXIO 66666**

Tissue Dispenser | Papiertuchspender  
 Dimensions H 30 cm, B 27 cm, T 13,5 cm  
 Materials SSp  
 Colour polished poliert



**NEXIO 66656**

Tissue Dispenser | Papiertuchspender  
 Dimensions H 30,5 cm, B 27 cm, T 13 cm  
 Materials SSm



**NEXIO 66429**

Tissue Box | Kosmetiktücherbox  
 Dimensions H 14 cm, B 13,5 cm, T 13,5 cm  
 Materials SSI  
 Colour Black



**NEXIO 66428**

Tissue Box | Kosmetiktücherbox  
 Dimensions H 14 cm, B 13,5 cm, T 13,5 cm  
 Materials SSp



**NEXIO 66427**

Tissue Box | Kosmetiktücherbox  
 Dimensions H 14 cm, B 13,5 cm, T 13,5 cm  
 Materials SSm



**NEXIO 66411**

Tissue Box | Kosmetiktücherbox  
 Dimensions H 7,5 cm, B 12 cm, T 24 cm  
 Materials SSI  
 Colour Black



**NEXIO 66660**

Tissue Box | Kosmetiktücherbox  
 Dimensions H 7,5 cm, B 12 cm, T 24 cm  
 Materials SSp



**NEXIO 66653**

Tissue Box | Kosmetiktücherbox  
 Dimensions H 7,5 cm, B 12 cm, T 24 cm  
 Materials SSm



## BATH ESSENTIALS

### WILO 66437

Tissue Box | Kosmetiktuchbox  
 Dimensions H 8,5 cm, B 25 cm, T 13 cm  
 Materials H1



### WILO 66438

Tissue Box | Kosmetiktuchbox  
 Dimensions H 14,5 cm, B 14 cm, T 14 cm  
 Materials H1



### MODO 66431

Storage Basket | Aufbewahrungskorb  
 Dimensions H 23 cm, Ø 31,5 cm  
 Materials Sb  
 Colour White



### MODO 66432

Storage Basket | Aufbewahrungskorb  
 Dimensions H 23 cm, Ø 31,5 cm  
 Materials Sb  
 Colour Satellite



### MODO 66430

Storage Basket | Aufbewahrungskorb  
 Dimensions H 23 cm, Ø 31,5 cm  
 Materials Sb  
 Colour Black



### MODO 69207

Tray | Ablageschale  
 Dimensions H 4 cm, B 20 cm, T 10 cm  
 Materials K2  
 Features Suitable for the MODO wall shelf.  
 Passend für MODO Wandregal.



### MODO 69208

Tray | Ablageschale  
 Dimensions H 2 cm, B 20 cm, T 10 cm  
 Materials H2  
 Features Suitable for the MODO wall shelf.  
 Passend für MODO Wandregal.



### MODO 69209

Tray | Ablageschale  
 Dimensions H 4 cm, B 10 cm, T 10 cm  
 Materials H2  
 Features Suitable for the MODO wall shelf.  
 Passend für MODO Wandregal.



**NEXIO 68956**

Shower Basket | Duschkorb  
 Dimensions H 8,5 cm, B 34 cm, T 8 cm  
 Materials SSp, K3, K4  
 Features With rubber strap to hold utensils  
 Mit Halteband für Utensilien



**NEXIO 68955**

Shower Basket | Duschkorb  
 Dimensions H 8,5 cm, B 25 cm, T 12 cm  
 Materials SSp, K3, K4  
 Features With rubber strap to hold utensils  
 Mit Halteband für Utensilien



**2FIX 68809**

Glue Kit, for up to 2 wall brackets |  
 Klebeset, für bis zu 2 Wandhalterungen

Keeps your bathroom accessories firmly attached to tiles, glass, concrete, plaster, metals and various plastics. High stability without drilling. Leaves no traces when removed.

Befestigt Ihre Badaccessoires sicher auf Fliesen, Glas, Beton Holz, Putz, Metallen und auf vielen Kunststoffen. Hohe Stabilität ohne zu Bohren. Rückstandslos ablösbar.



**NEXIO 68942**

Shower Basket | Duschkorb  
 Dimensions H 8,5 cm, B 34 cm, T 8 cm  
 Materials SSm, K3, K4  
 Features With rubber strap to hold utensils  
 Mit Halteband für Utensilien



**NEXIO 68941**

Shower Basket | Duschkorb  
 Dimensions H 8,5 cm, B 25 cm, T 12 cm  
 Materials SSm, K3, K4  
 Features With rubber strap to hold utensils  
 Mit Halteband für Utensilien



**SHOWER BASKET NEXIO**

Whatever you need in the shower – be it shampoos or sponges – the NEXIO shower caddy will keep it close at hand.

A plastic tray lines the bottom of the matt stainless steel caddy. This tray can be removed for cleaning. The wide rubber strip inside keeps hold of smaller items such as razors or your upturned bottle of shower gel.

No-drill mounting is also possible with the glue kit, which is available to order (item no. 68809).

**DUSCHKORB NEXIO**

Was auch immer Sie unter der Dusche benötigen – ob Shampoos oder Schwämme – mit dem NEXIO Duschkorb haben Sie alles griffbereit.

Im Korb ist ein Kunststofftablett eingelegt, das herausnehmbar ist und gereinigt werden kann. Das breite Gummiband innerhalb des Korbes hält kleine Utensilien wie Rasierer und die umgedrehte Duschgeltube.

Alternativ auch ohne Bohren montierbar (Klebeset erhältlich unter Nr. 68809).

**NEXIO 66330**

Shower Basket | Duschkorb  
 Dimensions H 8,5 cm, B 25 cm, T 12 cm  
 Materials SSb  
 Colour Black  
 Features With rubber strap to hold utensils  
 Mit Halteband für Utensilien



**NEXIO 66331**

Shower Basket | Duschkorb  
 Dimensions H 8,5 cm, B 34 cm, T 8 cm  
 Materials SSb  
 Colour Black  
 Features With rubber strap to hold utensils  
 Mit Halteband für Utensilien







PRODUCTS

---

# SCENT ESSENTIALS

## FEELING OF A SCENT SCENT OF A FEELING

Scents evoke memories more strongly than any other sensation, and for most people, they activate memories that are otherwise buried deep inside. And although a scent is by nature invisible, it nevertheless creates a special atmosphere, which makes it as important an element in interior design as a piece of furniture, a piece of art, or a vase of flowers.

At blomus, we have a long tradition of incorporating scents into interior design. Over the years, we have created a range of scents available as scented candles, room sprays, hand lotions, soaps, and sachets that rejuvenate your wardrobe. We design each unique fragrance from combinations of ingredients that originate from nature, each of which contributes to the complex sensory impression that constitutes a truly remarkable fragrance experience.

To us, scent is also a feeling. It is storytelling. It is collective memories. And it belongs to us all in the space we share.

## DAS GEFÜHL EINES DUFTE DER DUFT EINES GEFÜHLS

Düfte wecken Erinnerungen stärker als jede andere Sinneswahrnehmung und rufen bei den meisten Menschen Erinnerungen wach, die sonst tief im Inneren verborgen sind. Und obwohl ein Duft von Natur aus unsichtbar ist, schafft er dennoch eine besondere Atmosphäre, die ihn zu einem ebenso wichtigen Element der Innenraumgestaltung macht wie ein Möbelstück, ein Kunstwerk oder eine Vase mit Blumen.

Bei blomus haben wir eine lange Tradition darin, Düfte in die Innenarchitektur zu integrieren. Im Laufe der Jahre haben wir eine Reihe von Düften entwickelt, die als Duftkerzen, Raumsprays, Handlotionen, Seifen und Duftsäckchen erhältlich sind und Ihr Zuhause auffrischen. Wir entwerfen jeden Duft aus Kombinationen von Inhaltsstoffen, die ein wirklich bemerkenswertes Dufterlebnis ausmachen.

Für uns ist Duft auch ein Gefühl. Er erzählt Geschichten. Er ist kollektive Erinnerung. Und er gehört uns allen in dem Raum, den wir teilen.



Tuoksu



**TUOKSU 69283**

Scented Candle | Duftkerze

Dimensions H 9 cm, Ø 7,5 cm

Materials Gf, H12, W1

Features Fragrance: Cashmere, Burning Time  
35 h | Duft: Cashmere, Brenndauer  
35 h, Size: S

NEW

**69283**  
Cashmere Fragrance | Duft

**69286**  
Ocean Fragrance | Duft

**69288**  
Graphite Fragrance | Duft

**69287**  
Amber Fragrance | Duft

**69285**  
Sage Fragrance | Duft

**69284**  
Wood Fragrance | Duft

**69289**  
Velvet Fragrance | Duft
**TUOKSU 69290**

Scented Candle | Duftkerze

Dimensions H 11,5 cm, Ø 9,5 cm

Materials Gf, H12, W1

Features Fragrance: Cashmere, Burning Time  
45 h | Duft: Cashmere, Brenndauer  
45 h, Size: L

NEW

**69290**  
Cashmere Fragrance | Duft

**69293**  
Ocean Fragrance | Duft

**69295**  
Graphite Fragrance | Duft

**69292**  
Sage Fragrance | Duft

**69291**  
Wood Fragrance | Duft

**69296**  
Velvet Fragrance | Duft
**TUOKSU – LANDSCAPES OF THE SENSES**

Scents are like memories floating through the room – they touch us without being visible. TUOKSU – Finnish for ‘scent’ – is a collection that transforms our homes into landscapes of the senses.

Natural soy wax candles, diffusers, sachets and sprays offer little moments of calm, energy and joy. Sometimes gentle, sometimes intense, sometimes fresh like the sea, sometimes warm like a summer evening. Each fragrance tells its own story, accompanying us through the day and filling our homes with emotion.

**TUOKSU – LANDSCHAFTEN DER SINNE**

Düfte sind wie Erinnerungen, die durch den Raum schweben – sie berühren, ohne sichtbar zu sein. Mit TUOKSU – finnisch für „Duft“ – entsteht eine Kollektion, die unser Zuhause in Landschaften der Sinne verwandelt.

Natürliche Sojawachskerzen, Diffusoren, Sachets und Sprays schenken kleine Momente der Ruhe, der Energie, der Freude. Mal sanft, mal intensiv, mal frisch wie das Meer, mal warm wie ein Sommerabend. Jeder Duft erzählt eine eigene Geschichte, die uns durch den Tag begleitet und unser Zuhause mit Emotionen füllt.

# SCENT ESSENTIALS

## TUOKSU 69297

Room Fragrance Set | Raumduft Set  
 Dimensions H 24 cm, Ø 7,5 cm, V 100 ml  
 Materials Gf, K3  
 Features Fragrance: Cashmere, 8 Reed Sticks  
 Duft: Cashmere, 8 Stäbchen

NEW



69297  
Cashmere Fragrance | Duft

69300  
Ocean Fragrance | Duft

69302  
Graphite Fragrance | Duft

69299  
Sage Fragrance | Duft

69298  
Wood Fragrance | Duft

69301  
Amber Fragrance | Duft

69303  
Velvet Fragrance | Duft

## TUOKSU 69304

Room Spray | Raumspray  
 Dimensions H 12 cm, Ø 5 cm, V 100 ml  
 Materials Gf, K3  
 Features Fragrance: Cashmere  
 Duft: Cashmere

NEW



69304  
Cashmere Fragrance | Duft

69307  
Ocean Fragrance | Duft

69309  
Graphite Fragrance | Duft

69306  
Sage Fragrance | Duft

69305  
Wood Fragrance | Duft

69308  
Amber Fragrance | Duft

69310  
Velvet Fragrance | Duft

## TUOKSU 69336

Scented Sachets, 3 pcs | Duftsachets, 3 Stck.  
 Dimensions H 17 cm, B 11 cm, T 1,2 cm  
 Materials H9  
 Features Fragrance: Cashmere, with hanging hook | Duft: Cashmere, mit Haken zum Aufhängen

NEW



69336  
Cashmere Fragrance | Duft

69339  
Ocean Fragrance | Duft

69341  
Graphite Fragrance | Duft

69338  
Sage Fragrance | Duft

69337  
Wood Fragrance | Duft

69340  
Amber Fragrance | Duft

69342  
Velvet Fragrance | Duft







**FRABLI 65453**

Scented Marble Candle | Marmor-Duftkerze  
 Dimensions H 9 cm, Ø 8 cm  
 Materials ST6, W1, A  
 Features Fragrance: Mora, 18 h Burning Time  
 Duft: Mora, Brenndauer 18 h, Size: S



**65453**  
Mora Fragrance | Duft



**65451**  
Tonga Fragrance | Duft



**65455**  
Agave Fragrance | Duft



**65449**  
Cotton Island Fragrance | Duft



**65457**  
Figue Fragrance | Duft

**FRABLI 65454**

Scented Marble Candle | Marmor-Duftkerze  
 Dimensions H 11 cm, Ø 10 cm  
 Materials ST6, W1, A  
 Features Fragrance: Mora, 35 h Burning Time  
 Duft: Mora, Brenndauer 35 h, Size: L



**65454**  
Mora Fragrance | Duft



**65452**  
Tonga Fragrance | Duft



**65456**  
Agave Fragrance | Duft



**65450**  
Cotton Island Fragrance | Duft



**65458**  
Figue Fragrance | Duft

**FRABLI**

Marble – a symbol of timeless elegance and aesthetics. The noble natural stone, formed by the power of the earth and time itself, embodies luxury and sophistication in a unique way and has fascinated people for thousands of years. Travertine – a unique limestone formed by the slow interaction of minerals and spring water – is a timeless jewel of nature. Travertine is characterised by its porosity, which gives it an unmistakable texture.

The natural stones are not only an aesthetic statement, but also a sign of durability and quality. Thanks to the aluminium vessels, the containers can be used both as long-lasting scented candles and as storage containers once the candle has burnt out. The scented candles contain selected aroma compositions with a subtle note and are made of natural soy wax. They therefore burn with low soot emissions.

**FRABLI**

Marmor – ein Symbol für zeitlose Eleganz und Ästhetik. Der edle Naturstein, geformt durch die Kraft der Erde und die Zeit selbst, verkörpert Luxus und Raffinesse auf eine einzigartige Weise und fasziniert die Menschen seit Jahrtausenden. Travertin – ein einzigartiger Kalkstein, geformt durch das langsame Zusammenspiel von Mineralien und Quellwasser, ist ein zeitloses Juwel der Natur. Charakteristisch ist die Porosität des Travertins, die ihm eine unverkennbare Textur verleiht.

Die Natursteine sind nicht nur ein ästhetisches Statement, sondern auch ein Zeichen von Beständigkeit und Qualität. Die Gefäße können dank des Aluminiumbehälters sowohl langlebig als Duftkerze als auch als Aufbewahrungsdosen genutzt werden, sobald die Kerze ausgebrannt ist. Die Duftkerzen enthalten ausgesuchte Aromakompositionen mit einer dezenten Note und bestehen aus Sojanaturwachs. Sie brennen daher rußarm.

## SCENT ESSENTIALS

### FRABLI 65536

Room Spray | Raumspray  
Dimensions H 14 cm, Ø 5 cm, V 100 ml  
Materials ST5, Gs  
Features Fragrance: Mora  
Duft: Mora



65536  
Mora Fragrance | Duft



65535  
Tonga Fragrance | Duft



65537  
Agave Fragrance | Duft



65534  
Cotton Island Fragrance | Duft



65538  
Figue Fragrance | Duft

### FRABLI 67392

Refill Room Spray | Raumspray Nachfüllpack  
Dimensions V 100 ml  
Materials H9  
Features Fragrance: Mora  
Duft: Mora



67392  
Mora Fragrance | Duft



67391  
Tonga Fragrance | Duft



67393  
Agave Fragrance | Duft



67390  
Cotton Island Fragrance | Duft



67394  
Figue Fragrance | Duft

### FRABLI ROOM SPRAY

With the FRABLI room spray, you can distribute the pleasant and refreshing fragrances of the scented candles of the same name in your home. Not only the fragrance compositions but also the design of the sprays with the elegant marble and travertine lids are the perfect match for the candles and are the ideal accessory for your bathroom or living room.

### FRABLI RAUMSPRAY

Mit dem FRABLI Raumspray können Sie die angenehmen und erfrischenden Düfte der gleichnamigen Duftkerzen in Ihrem Zuhause versprühen. Nicht nur die Duftkompositionen, sondern auch das Design der Sprays mit den eleganten Marmor- und Travertindeckeln bilden das perfekte Match zu den Kerzen und eignen sich als perfektes Accessoire für Ihr Bad oder Ihre Wohnräume.







**VALOA 65540**

Scented Candle | Duftkerze  
 Dimensions H 7,5 cm, Ø 7,5 cm  
 Materials Gk, W1  
 Features Fragrance: Neroli - No. 02,  
 30 h Burning Time  
 Duft: Neroli - No. 02,  
 Brenndauer 30 h, Size: S



**65540**  
 Neroli Fragrance | Duft



**65539**  
 Ylang-Ylang Fragrance | Duft



**65542**  
 Vetiver Fragrance | Duft



**65541**  
 Bergamot Fragrance | Duft



**65295**  
 Fig Tree Fragrance | Duft

**VALOA 65544**

Scented Candle | Duftkerze  
 Dimensions H 9,5 cm, Ø 9 cm  
 Materials Gk, W1  
 Features Fragrance: Neroli - No. 02,  
 45 h Burning Time  
 Duft: Neroli - No. 02, Brenndauer  
 45 h, Size: L



**65544**  
 Neroli Fragrance | Duft



**65543**  
 Ylang-Ylang Fragrance | Duft



**65546**  
 Vetiver Fragrance | Duft



**65545**  
 Bergamot Fragrance | Duft



**65296**  
 Fig Tree Fragrance | Duft

**VALOA**

It is fragrance that changes our perception and mood. VALOA awakens the senses and takes us on a wonderful scented journey.

**VALOA**

Wohlgeruch verändert unsere Wahrnehmung und Stimmung. Die Düfte der Serie VALOA wecken die Sinne und nehmen uns mit auf eine wunderbare Duftreise.



## SCENT ESSENTIALS

### FRAGA 67484

Room Spray | Raumspray  
Dimensions H 14 cm, Ø 5 cm, V 100 ml  
Materials ST4, Gf  
Features Fragrance: French Cotton  
Duft: French Cotton

NEW



67484  
French Cotton Fragrance | Duft



67485  
Sandalwood Myrrh Fragrance | Duft



67486  
Soft Linen Fragrance | Duft



67487  
Fig Fragrance | Duft



67488  
Sea Salt & Sage Fragrance | Duft



### FRAGA 67574

Refill Room Spray | Raumspray Nachfüllpack  
Dimensions V 100 ml  
Materials H9  
Features Fragrance: French Cotton  
Duft: French Cotton

NEW



67574  
French Cotton Fragrance | Duft



67575  
Sandalwood Myrrh Fragrance | Duft



67576  
Soft Linen Fragrance | Duft



67577  
Fig Fragrance | Duft



67578  
Sea Salt & Sage Fragrance | Duft



### FRAGA ROOM SPRAY

Fragrances are invisible companions in our everyday lives. They lift our spirits, give us a sense of lightness or envelop us in tranquillity. With FRAGA room sprays, you can create an atmosphere at the touch of a button – minimalist in design with a concrete look, clear, unobtrusive and yet highly effective. A fine spray transforms rooms into oases of relaxation or freshness. And because every moment returns, there are matching refill fragrances – for rituals that last.

### FRAGA RAUMSPRAY

Düfte sind unsichtbare Begleiter unseres Alltags. Sie heben die Stimmung, schenken Leichtigkeit oder hüllen uns in Ruhe. Mit den FRAGA Raumsprays wird Atmosphäre auf Knopfdruck spürbar – minimalistisch gestaltet in Betonoptik, klar, unaufdringlich und doch voller Wirkung. Ein feiner Sprühstoß verwandelt Räume in Oasen der Entspannung oder Frische. Und weil jeder Moment wiederkehrt, gibt es die passenden Nachfülldüfte – für Rituale, die bleiben.



**FRAGA 65649**

Scented Candle | Duftkerze  
 Dimensions H 8 cm, Ø 6,5 cm  
 Materials ST4, W1  
 Features Fragrance: French Cotton,  
 24 h Burning Time  
 Duft: French Cotton,  
 Brenndauer 24 h, Size: S



**65649**  
 French Cotton Fragrance | Duft

**65652**  
 Sandalwood Myrrh Fragrance | Duft

**65653**  
 Soft Linen Fragrance | Duft

**69044**  
 Morning Rays Fragrance | Duft

**65650**  
 Fig Fragrance | Duft

**65651**  
 Sea Salt & Sage Fragrance | Duft

**69051**  
 Bergamot Orange Fragrance | Duft

**66455**  
 Cinnamon & Apple Fragrance | Duft

**65952**  
 Kyoto Yume Fragrance | Duft

**65896**  
 Rose & White Musk Fragrance | Duft

**FRAGA 65654**

Scented Candle | Duftkerze  
 Dimensions H 11 cm, Ø 9 cm  
 Materials ST4, W1  
 Features Fragrance: French Cotton,  
 55 h Burning Time  
 Duft: French Cotton,  
 Brenndauer 55 h, Size: M



**65654**  
 French Cotton Fragrance | Duft

**65657**  
 Sandalwood Myrrh Fragrance | Duft

**65658**  
 Soft Linen Fragrance | Duft

**69045**  
 Morning Rays Fragrance | Duft

**65655**  
 Fig Fragrance | Duft

**65656**  
 Sea Salt & Sage Fragrance | Duft

**69052**  
 Bergamot Orange Fragrance | Duft

**66453**  
 Cinnamon & Apple Fragrance | Duft

**65953**  
 Kyoto Yume Fragrance | Duft

**65897**  
 Rose & White Musk Fragrance | Duft

**FRAGA 69218**

Room Fragrance Set | Raumduft Set  
 Dimensions H 27,5 cm, Ø 9 cm, V 100 ml  
 Materials ST4, Gf, K3  
 Features Fragrance: French Cotton, 5 Reed Sticks | Duft: French Cotton, 5 Stäbchen



- |  |   |  |
|--|---|--|
| <p><b>69218</b><br/>French Cotton Fragrance   Duft</p>         | <p><b>69224</b><br/>Sandalwood Myrrh Fragrance   Duft</p>     | <p><b>69226</b><br/>Soft Linen Fragrance   Duft</p>          |
| <p><b>67407</b><br/>Morning Rays Fragrance   Duft</p>          | <p><b>69220</b><br/>Fig Fragrance   Duft</p>                  | <p><b>69222</b><br/>Sea Salt &amp; Sage Fragrance   Duft</p> |
| <p><b>67406</b><br/>Bergamot Orange Fragrance   Duft</p>       | <p><b>66409</b><br/>Cinnamon &amp; Apple Fragrance   Duft</p> | <p><b>69232</b><br/>Kyoto Yume Fragrance   Duft</p>          |
| <p><b>69228</b><br/>Rose &amp; White Musk Fragrance   Duft</p> |   |  |

**FRAGA 69219**

Room Fragrance - Refill Set | Raumduft Nachfüllset  
 Dimensions H 26 cm, Ø 4,5 cm, V 100 ml  
 Materials K3  
 Features Fragrance: French Cotton, 5 Reed Sticks, recycled PET bottle | Duft: French Cotton, 5 Stäbchen, recycelte PET Flasche



- |  |   |  |
|--|---|--|
| <p><b>69219</b><br/>French Cotton Fragrance   Duft</p>         | <p><b>69225</b><br/>Sandalwood Myrrh Fragrance   Duft</p>     | <p><b>69227</b><br/>Soft Linen Fragrance   Duft</p>          |
| <p><b>67409</b><br/>Morning Rays Fragrance   Duft</p>          | <p><b>69221</b><br/>Fig Fragrance   Duft</p>                  | <p><b>69223</b><br/>Sea Salt &amp; Sage Fragrance   Duft</p> |
| <p><b>67408</b><br/>Bergamot Orange Fragrance   Duft</p>       | <p><b>66410</b><br/>Cinnamon &amp; Apple Fragrance   Duft</p> | <p><b>69233</b><br/>Kyoto Yume Fragrance   Duft</p>          |
| <p><b>69229</b><br/>Rose &amp; White Musk Fragrance   Duft</p> |   |  |





**SATOMI 65129**

Hand Soap | Handseife  
 Dimensions H 16 cm, Ø 8 cm, V 500 ml  
 Features Scent: Fuji Tea, 25% organic Aloe Vera, 95% natural ingredients  
 Duft: Fuji Tea, 25% Bio Aloe Vera, 95% natürliche Inhaltsstoffe



**65134**  
 Modern Lemon Fragrance | Duft



**65129**  
 Fuji Tea Fragrance | Duft



**65163**  
 Fresh Laundry Fragrance | Duft



**SATOMI 65547**

Scented Sachets, 3 pcs. |  
 Duftsachets, 3 Stck.  
 Dimensions H 16 cm, B 11 cm, T 1 cm  
 Materials H9  
 Features Scent: Modern Lemon, with hanging hook | Duft: Modern Lemon, mit Haken zum Aufhängen



**65547**  
 Modern Lemon Fragrance | Duft



**65548**  
 Fuji Tea Fragrance | Duft



**65549**  
 Fresh Laundry Fragrance | Duft



**SATOMI 65186**

Hand Lotion | Handlotion  
 Dimensions H 12,5 cm, Ø 8 cm, V 300 ml  
 Features Scent: Fuji Tea, 25% organic Aloe Vera, 95% natural ingredients  
 Duft: Fuji Tea, 25% Bio Aloe Vera, 95% natürliche Inhaltsstoffe



**65186**  
 Modern Lemon Fragrance | Duft



**65164**  
 Fuji Tea Fragrance | Duft



**65187**  
 Fresh Laundry Fragrance | Duft



**SATOMI 65205**

Refill Hand Soap | Handseife Nachfüllpack  
 Dimensions V 1 l  
 Features Scent: Modern Lemon, 25% organic Aloe Vera, 95% natural ingredients  
 Duft: Modern Lemon, 25% Bio Aloe Vera, 95% natürliche Inhaltsstoffe



**65205**  
 Modern Lemon Fragrance | Duft



**65201**  
 Fuji Tea Fragrance | Duft



**65206**  
 Fresh Laundry Fragrance | Duft



**SATOMI 65188**

Dishwashing Soap | Geschirrspülmittel  
 Dimensions H 16 cm, Ø 8 cm, V 500 ml  
 Features Scent Clean Cucumber, 25% organic Aloe Vera, 95% natural ingredients | Duft Clean Cucumber, 25% Bio Aloe Vera, 95% natürliche Inhaltsstoffe



**SATOMI 65207**

Refill Dishwashing Soap | Geschirrspülmittel Nachfüllpack  
 Dimensions V 1 l  
 Features Scent Clean Cucumber, 25% organic Aloe Vera, 95% natural ingredients | Duft Clean Cucumber, 25% Bio Aloe Vera, 95% natürliche Inhaltsstoffe







PRODUCTS

---

# OUTDOOR ESSENTIALS

FURNITURE	P. 292
LIGHTING	P. 320
DECORATION	P. 336



**STAY 62355**

Lounger Chair | Loungesessel  
 Dimensions H 68 cm, B 75 cm, T 95 cm  
 Materials T3, K3  
 Colour Lily White/Duck Green  
 Features With handle on the back  
 Mit Griff an der Rückseite

NEW



**62355**  
Lily White/Duck Green



**62352**  
Lily White/Elephant Skin



**62353**  
Lily White/Key Largo



**62354**  
Lily White/Black

**STAY 62328**

# Day Bed | Day Bed  
 Dimensions H 25 cm, B 120 cm, T 190 cm  
 Materials T3, K3, Sb  
 Colour Lily White/Duck Green  
 Features Incl. metal frame  
 Inkl. Metallbügel, Size: L

NEW



**62328**  
Lily White/Duck Green



**62319**  
Lily White/Elephant Skin



**62322**  
Lily White/Key Largo



**62325**  
Lily White/Black

**STAY 62329**

Cushion | Kissen  
 Dimensions B 70 cm, T 30 cm  
 Materials T3, K3  
 Colour Lily White/Duck Green

NEW



**62329**  
Lily White/Duck Green

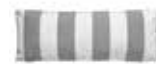

**62320**  
Lily White/Elephant Skin

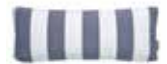

**62323**  
Lily White/Key Largo



**62326**  
Lily White/Black

**STAY 62330**

Cushion | Kissen  
 Dimensions B 45, T 45 cm  
 Materials T3, K3  
 Colour Lily White/Duck Green

NEW



**62330**  
Lily White/Duck Green



**62321**  
Lily White/Elephant Skin



**62324**  
Lily White/Key Largo



**62327**  
Lily White/Black

# Pallet delivery only. Nur Palettenversand.

# OUTDOOR ESSENTIALS

## STAY 62336

Lounger Chair | Loungesessel  
 Dimensions H 68 cm, B 75 cm, T 95 cm  
 Materials T3, K3  
 Colour Cloud Bouclé  
 Features With handle on the back  
 Mit Griff an der Rückseite

NEW



62336  
Cloud Bouclé



62334  
Earth Bouclé



62335  
Stone Bouclé



## STAY 62342

# 2-Seater | 2-Sitzer-Sofa  
 Dimensions H 25 cm, B 120 cm, T 120 cm  
 Materials T3, K3, Sb  
 Colour Cloud Bouclé  
 Features Incl. metal frame  
 Inkl. Metallbügel, Size: L

NEW



62342  
Cloud Bouclé



62340  
Earth Bouclé



62341  
Stone Bouclé

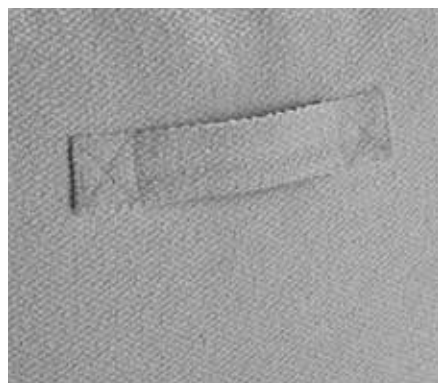

The integrated carrying handle on the STAY and GROW Lounger Chairs allows you to transport your seat comfortably.

Mit dem integrierten Tragegriff an den STAY und GROW Loungesesseln lässt sich Ihr Sitzmöbel bequem transportieren.

## STAY 62348

# 3-Seater | 3-Sitzer-Sofa  
 Dimensions H 25 cm, B 180 cm, T 120 cm  
 Materials T3, K3, Sb  
 Colour Cloud Bouclé  
 Features Incl. metal frame  
 Inkl. Metallbügel, Size: XL

NEW



62348  
Cloud Bouclé



62346  
Earth Bouclé



62347  
Stone Bouclé



## STAY 62297

# Day Bed S | Day Bed S  
 Dimensions H 25 cm, B 80 cm, T 190 cm  
 Materials T3, K3, Sb  
 Colour Cloud Bouclé  
 Features Incl. metal frame  
 Inkl. Metallbügel, Size S

NEW



62297  
Cloud Bouclé



62300  
Earth Bouclé



62301  
Stone Bouclé



## STAY 62296

# Day Bed | Day Bed  
 Dimensions H 25 cm, B 120 cm, T 190 cm  
 Materials T3, K3, Sb  
 Colour Cloud Bouclé  
 Features Incl. metal frame  
 Inkl. Metallbügel, Size: L

62296 - NEW  
Cloud Bouclé



62280  
Earth Bouclé



62283  
Stone Bouclé





**STAY 62298**

Cushion | Kissen  
 Dimensions B 70 cm, T 30 cm  
 Materials T3, K3  
 Colour Cloud Bouclé

62298 - NEW  
 Cloud Bouclé



62281  
 Earth Bouclé



62284  
 Stone Bouclé



**STAY 62299**

Cushion | Kissen  
 Dimensions B 45, T 45 cm  
 Materials T3, K3  
 Colour Cloud Bouclé

62299 - NEW  
 Cloud Bouclé



62282  
 Earth Bouclé



62285  
 Stone Bouclé



# Pallet delivery only. Nur Palettenversand.

# OUTDOOR ESSENTIALS

## STAY 62333

Lounger Chair | Loungesessel  
 Dimensions H 68 cm, B 75 cm, T 95 cm  
 Materials T3, K3  
 Colour Cloud  
 Features With handle on the back  
 Mit Griff an der Rückseite

62333  
Cloud



NEW



62331  
Stone



62332  
Coal



## STAY 62339

# 2-Seater | 2-Sitzer-Sofa  
 Dimensions H 25 cm, B 120 cm, T 120 cm  
 Materials T3, K3, Sb  
 Colour Cloud  
 Features Incl. metal frame  
 Inkl. Metallbügel, Size: L

62339  
Cloud



NEW



62337  
Stone



62338  
Coal



## STAY 62345

# 3-Seater | 3-Sitzer-Sofa  
 Dimensions H 25 cm, B 180 cm, T 120 cm  
 Materials T3, K3, Sb  
 Colour Cloud  
 Features Incl. metal frame  
 Inkl. Metallbügel, Size: XL

NEW

62345  
Cloud



62343  
Stone



62344  
Coal



## STAY 62005

# Pouf | Pouf  
 Dimensions H 32 cm, B 60 cm, T 60 cm  
 Materials T3, K3  
 Colour Cloud



62005  
Cloud



62003  
Stone



62004  
Coal



62098  
Earth



62091  
Ocean







**STAY 62002**

# Lounger | Lounger  
 Dimensions H 75 cm, B 60 cm, T 120 cm  
 Materials T3, K3  
 Colour Cloud



**62002**  
Cloud



**62000**  
Stone



**62001**  
Coal



**62097**  
Earth



**62090**  
Ocean



# Pallet delivery only. Nur Palettenversand.



# OUTDOOR ESSENTIALS

## STAY 62040

# Lounger L | Lounger L  
 Dimensions H 88 cm, B 80 cm, T 157 cm  
 Materials T3, K3  
 Colour Cloud



62040  
Cloud



62038  
Stone



62039  
Coal



62100  
Earth



62093  
Ocean



## STAY 62043

# Day Bed S | Day Bed S  
 Dimensions H 25 cm, B 80 cm, T 190 cm  
 Materials T3, K3, Sb  
 Colour Cloud  
 Features Incl. metal frame  
 Inkl. Metallbügel, Size: S



62043  
Cloud



62041  
Stone



62042  
Coal



62101  
Earth



62094  
Ocean



## STAY 62008

# Day Bed | Day Bed  
 Dimensions H 25 cm, B 120 cm, T 190 cm  
 Materials T3, K3, Sb  
 Colour Cloud  
 Features Incl. metal frame  
 Inkl. Metallbügel, Size: L



62008  
Cloud



62006  
Stone



62007  
Coal



62099  
Earth



62092  
Ocean



**STAY 62011**

Cushion | Kissen  
 Dimensions B 45 cm, T 45 cm  
 Materials T3, K3  
 Colour Cloud



62011  
Cloud



62009  
Stone



62010  
Coal



62102  
Earth



62095  
Ocean



**STAY 62014**

Cushion | Kissen  
 Dimensions B 70 cm, T 30 cm  
 Materials T3, K3  
 Colour Cloud



62014  
Cloud



62012  
Stone



62013  
Coal



62103  
Earth



62096  
Ocean



**STAY – JUST RELAX**

Reliable, uncomplicated and always there for you... The STAY outdoor furniture collection by Florian Kallus and Sebastian Schneider from the kaschkasch design studio for blomus is like a good friend who makes your life a little more pleasant.

Outer: Water-repellent  
 Inner: Waterproof thanks to TPU coating  
 Filling: EPS beads

STAY outdoor furniture comes standard with a robust 2-layer premium base. The water-repellent and quick-drying coating protects the inner waterproof layer from damage. The special material properties of the base surface ensure that mould stains cannot settle in.

**STAY – EINFACH RELAXED BLEIBEN**

Zuverlässig, unkompliziert und immer für Sie da... Die STAY-Outdoor-Möbelkollektion von Florian Kallus und Sebastian Schneider vom Design Studio kaschkasch für blomus ist wie ein guter Freund, der Ihnen das Leben ein wenig angenehmer macht.

Außenseite: Wasserabweisend  
 Innenseite: durch TPU-Beschichtung wasserfest  
 Füllung: EPS-Perlen

Die STAY-Outdoor-Möbel sind standardmäßig mit einem robusten 2-lagigen Premium-Boden ausgestattet. Der wasserabweisende und schnell trocknende Belag schützt hierbei die innere wasserdichte Schicht vor Beschädigungen. Die besonderen Materialeigenschaften der Bodenfläche sorgen dafür, dass Stockflecken sich nicht festsetzen können.

# Pallet delivery only. Nur Palettenversand.





#### STAY PROTECTION COVER & STORAGE COVER

With its perfect fit the STAY protection covers can easily be slipped over the STAY Outdoor furniture. The lightweight and robust Protection Cover can be tightened and adjusted with a cord and a stopper to prevent it from moving and to keep the furniture free of dust and soiling.

To store the furniture during the winter for longer periods of time we recommend the STAY Storage Covers for ideal protection. The cover can be closed with a zip fastener so the furniture is protected on all sides. The light weight and ideal fit for all the STAY Outdoor furniture units make them easy to use.

#### STAY SCHUTZHÜLLE & AUFBEWAHRUNGSHÜLLE

Aufgrund ihrer guten Passform können die STAY Schutzhüllen schnell und unkompliziert über die STAY Outdoor-Möbel gestülpt werden. Die leichte und robuste Schutzhülle umschließt mit Hilfe von Kordel und Stopper eng die Möbel, sodass die Hülle nicht verrutschen kann und die Möbel stets vor Verschmutzungen bewahrt.

Zur längeren Einlagerung im Winterquartier empfehlen wir die Verwendung der STAY Aufbewahrungshüllen für den bestmöglichen Schutz der Outdoor-Möbel. Durch einen Reißverschluss kann die Schutzhülle geschlossen werden, sodass das Möbel von allen Seiten geschützt ist. Das leichte Gewicht und die passende Form für jedes STAY Outdoor-Möbel sorgen für eine einfache Handhabung.



The QR code leads you to the STAY Product Fact Sheet.

Der QR-Code führt Sie zu dem STAY Product Fact Sheet.

**STAY 62036**

Protection Cover for Lounger |  
Schutzhülle für Lounger  
Dimensions H 75 cm, B 65 cm, T 125 cm  
Materials T3  
Colour Light Gray  
Features Cover with drawstring and clamp,  
breathable and water repellent  
Abdeckung mit Kordelzug und  
Klemme, atmungsaktiv und wasser-  
abweisend



**62036**  
for Lounger | für Lounger



**62035**  
for Pouf | für Pouf



**62019**  
for Lounger L | für Lounger L



**62018**  
for Day Bed S | für Day Bed S



**62037**  
for Day Bed Metal frame | für Day  
Bed mit Metallbügel

Further information on protective covers for the Lounger Chair, 2-Seater and 3-Seater can be found under the QR code on the left.  
Weitere Informationen zu den Schutzhüllen für den Lounger Sessel, 2-Sitzer und 3-Sitzer finden Sie unter dem links stehenden QR-Code.

**STAY 62049**

Storage Cover for Lounger L |  
Aufbewahrungshülle für Lounger L  
Dimensions H 81 cm, B 80 cm, T 157 cm  
Materials T3  
Colour Light Gray  
Features Premium storage protection with  
zipper, breathable and water repellent  
Premium Aufbewahrungsschutz mit  
Reißverschluss, atmungsaktiv und  
wasserabweisend



**62046**  
for Lounger | für Lounger



**62045**  
for Pouf | für Pouf



**62049**  
for Lounger L | für Lounger L



**62048**  
for Day Bed S | für Day Bed S



**62047**  
for Day Bed | für Day Bed

Further information on storage covers for the Lounger Chair, 2-Seater and 3-Seater can be found under the QR code on the left.  
Weitere Informationen zu den Aufbewahrungshüllen für den Lounger Sessel, 2-Sitzer und 3-Sitzer finden Sie unter dem links stehenden QR-Code.

**MEDA**

For ideal maintenance of your STAY furniture collection we offer our MEDA Cleaning- and Maintenance products for outdoor fabrics. Stains and unpleasant smells can easily be removed with our MEDA Cleaning Agent. After cleaning we recommend our MEDA Waterproofing Spray which protects the outdoor fabrics water- and dirt repellent features.

Zur optimalen Pflege Ihrer STAY Möbelkollektion und Kissen bieten wir unsere MEDA Reinigungs- und Pflegeprodukte für Outdoor-Textilien an. Flecken und unangenehme Gerüche lassen sich einfach mit unserem MEDA Reinigungsmittel entfernen. Nach der Reinigung empfehlen wir unser MEDA Imprägniermittel, welches die ursprüngliche wasser- und schmutzabweisende Imprägnierung des Outdoor-Stoffes erhält.

**MEDA 31058**

Cleaning Agent for Outdoor Textiles |  
Reinigungsmittel für Outdoor-Textilien  
Dimensions 1 l



**MEDA 31059**

Waterproofing Spray for Outdoor Textiles |  
Imprägniermittel für Outdoor-Textilien  
Dimensions 1 l



## OUTDOOR ESSENTIALS

### STAY 62218

Outdoor Side Table | Garten Beistelltisch  
Dimensions H 35 cm, Ø 50 cm  
Materials Ab, K1  
Colour White  
Features Size: L

NEW



62218  
White



62222  
Silk Gray



62221  
Granite Gray



62219  
Warm Gray



62220  
Magnet



### STAY 62015

Outdoor Side Table | Garten Beistelltisch  
Dimensions H 45 cm, Ø 40 cm  
Materials Ab, K1  
Colour White  
Features Size: S



62015  
White



62213  
Silk Gray



62212  
Granite Gray



62016  
Warm Gray



62017  
Magnet



### OUTDOOR SIDE TABLE STAY

The STAY table was designed by Florian Kallus and Sebastian Schneider from the kaschkasch design studio for blomus to match the STAY furniture collection. The table is made of powder-coated aluminium and is therefore corrosion-resistant. The gently rounded edges of the tabletop make it easy to position on the patio or in the garden. The weight plate in the base keeps it stable even in windy weather.

### OUTDOOR TISCH STAY

Der STAY-Tisch wurde von Florian Kallus und Sebastian Schneider vom Designstudio kaschkasch für blomus passend zur STAY Möbelkollektion entworfen. Der Tisch besteht aus pulverbeschichtetem Aluminium und ist daher korrosionsbeständig. Durch die sanft abgerundeten Kanten der Platte lässt er sich leicht auf der Terrasse oder im Garten positionieren. Die Beschwerungsplatte im Fuß hält ihn auch bei windigem Wetter stabil.





**PORTER 62223**

Outdoor Side Table | Garten Beistelltisch  
 Dimensions H 58 cm, Ø 42 cm  
 Materials Ab, K1  
 Colour White  
 Features Tabletop can be used on both sides  
 Tischplatte beidseitig nutzbar

NEW



**PORTER 62224**

Outdoor Side Table | Garten Beistelltisch  
 Dimensions H 58 cm, Ø 42 cm  
 Materials Ab, K1  
 Colour Black  
 Features Tabletop can be used on both sides  
 Tischplatte beidseitig nutzbar

NEW



**PORTER 62225**

Outdoor Side Table | Garten Beistelltisch  
 Dimensions H 58 cm, Ø 42 cm  
 Materials Ab, K1  
 Colour Granite Gray  
 Features Tabletop can be used on both sides  
 Tischplatte beidseitig nutzbar

NEW



**PORTER 62226**

Outdoor Side Table | Garten Beistelltisch  
 Dimensions H 58 cm, Ø 42 cm  
 Materials Ab, K1  
 Colour Silk Gray  
 Features Tabletop can be used on both sides  
 Tischplatte beidseitig nutzbar

NEW



**PORTER – DESIGN BY SEBASTIAN HERKNER**

Some pieces of furniture are like faithful companions – they are always there when you need them. The PORTER table by Sebastian Herkner is one such companion. Its round handle invites you to take it with you – out into the garden, to your favourite spot, back into the living room. Made of powder-coated aluminium, robust yet lightweight, it adapts to any environment. PORTER stands for flexibility, for life in motion – and for moments you love to share.

**PORTER – DESIGN VON SEBASTIAN HERKNER**

Manche Möbelstücke gleichen treuen Gefährten – sie sind immer da, wenn man sie braucht. Der PORTER Tisch von Sebastian Herkner ist so ein Begleiter. Sein runder Griff wirkt wie eine Einladung, ihn mitzunehmen – hinaus in den Garten, an den Lieblingsplatz, zurück ins Wohnzimmer. Gefertigt aus pulverbeschichtetem Aluminium, robust und doch leicht, passt er sich jeder Umgebung an. PORTER steht für Flexibilität, für das Leben in Bewegung – und für Momente, die man gern teilt.







**GROW 2.0**

The GROW outdoor collection, which has been tried and tested for several years now, embodies exactly what its name promises: growth, change and the creation of space for new possibilities in your outdoor area.

Although designed for outdoor use, GROW has some of the same qualities as classic indoor furniture. The softness of the fabrics around a soft foam core and the puffy, slightly curved shapes ensure that the furniture is comfortable and inviting when relaxing outdoors.

**GROW 2.0**

Die bereits seit einigen Jahren bewährte Outdoorkollektion GROW verkörpert genau das, was ihr Name verspricht: Wachstum, Wandel und das Schaffen von Raum für neue Möglichkeiten in Ihrem Außenbereich.

Obwohl für den Außenbereich konzipiert, hat GROW einige der gleichen Qualitäten wie klassische Indoor-Möbel. Die Weichheit der Stoffe um einen Weichschaumkern sowie die bauschigen, leicht geschwungenen Formen sorgen dafür, dass die Möbel beim Entspannen im Freien gemütlich und einladend wirken.

**GROW 62351**

Lounger Chair | Loungesessel  
 Dimensions H 85 cm, B 100 cm, T 110 cm  
 Materials T3  
 Colour Cloud Bouclé  
 Features With handle on the back  
 Mit Griff an der Rückseite



**62351**  
Cloud Bouclé

**NEW**



**Unit 7**



**62349**  
Earth Bouclé



**62350**  
Stone Bouclé



**GROW 62311**

Corner Seater Unit | Ecksitzer Modul  
 Dimensions H 68 cm, B 95 cm, T 95 cm  
 Materials T3  
 Colour Cloud Bouclé  
 Features Matching Protection Cover 62080 and Floor Plate 62107  
 Passende Schutzhülle 62080 und Bodenplatte 62107



**Unit 1**

**62311 - NEW**  
 Cloud Bouclé



**62240**  
 Earth Bouclé



**62247**  
 Stone Bouclé



**GROW 62312**

Single Seater Unit | 1-Sitzer Modul  
 Dimensions H 68 cm, B 75 cm, T 95 cm  
 Materials T3  
 Colour Cloud Bouclé  
 Features Matching Protection Cover 62081 and Floor Plate 62108  
 Passende Schutzhülle 62081 und Bodenplatte 62108



**Unit 2**

**62312 - NEW**  
 Cloud Bouclé



**62241**  
 Earth Bouclé



**62248**  
 Stone Bouclé



**GROW 62313**

Pouf Unit | Hocker Modul  
 Dimensions H 38 cm, B 75 cm, T 75 cm  
 Materials T3  
 Colour Cloud Bouclé  
 Features Matching Protection Cover 62084 and Floor Plate 62111  
 Passende Schutzhülle 62084 und Bodenplatte 62111



**Unit 5**

**62313 - NEW**  
 Cloud Bouclé



**62242**  
 Earth Bouclé



**62249**  
 Stone Bouclé



**GROW 62314**

Ottoman Unit | Chaiselongue Modul  
 Dimensions H 68 cm, B 75 cm, T 145 cm  
 Materials T3  
 Colour Cloud Bouclé  
 Features Matching Protection Cover 62083 and Floor Plate 62110  
 Passende Schutzhülle 62083 und Bodenplatte 62110



**Unit 4**

**62314 - NEW**  
 Cloud Bouclé



**62243**  
 Earth Bouclé



**62250**  
 Stone Bouclé



**GROW 62315**

Double Seater Unit | 2-Sitzer Modul  
 Dimensions H 68 cm, B 130 cm, T 95 cm  
 Materials T3  
 Colour Cloud Bouclé  
 Features Matching Protection Cover 62082 and Floor Plate 62109  
 Passende Schutzhülle 62082 und Bodenplatte 62109



**Unit 3**

**62315 - NEW**  
 Cloud Bouclé



**62244**  
 Earth Bouclé



**62251**  
 Stone Bouclé



**GROW 62316**

Armchair | Armsessel  
 Dimensions H 68 cm, B 105 cm, T 75 cm  
 Materials T3  
 Colour Cloud Bouclé  
 Features Matching Protection Cover 62292 and Floor Plate 62108  
 Passende Schutzhülle 62292 und Bodenplatte 62108



**Unit 6**

**62316 - NEW**  
 Cloud Bouclé



**62287**  
 Earth Bouclé



**62286**  
 Stone Bouclé



## OUTDOOR ESSENTIALS

### GROW 62317

Cushion | Kissen  
 Dimensions B 38 cm, T 38 cm  
 Materials T3  
 Colour Cloud Bouclé



62317 - NEW  
 Cloud Bouclé



62245  
 Earth Bouclé



62252  
 Stone Bouclé



### GROW 62318

Cushion | Kissen  
 Dimensions B 60 cm, T 25 cm  
 Materials T3  
 Colour Cloud Bouclé



62318 - NEW  
 Cloud Bouclé



62246  
 Earth Bouclé



62253  
 Stone Bouclé



## GROW 2.0 – OUTDOOR FURNITURE WITH ENDLESS POSSIBILITIES

The lounge furniture designed by German design studio kaschkasch is vacuum-packed and delivered in shippable boxes. In just 48 hours, the modules transform into a cosy outdoor lounge. GROW 2.0 requires neither a shipping company nor a professional assembly team. For detailed information, please refer to the GROW fact sheet and the assembly video.

However, there may be slight variations in the shape of the individual modules – we consider each GROW module to be unique. The modular elements can be combined individually and offer endless design options – true to the name GROW. The flexible design adapts to your needs. You can create both the classic, family-friendly L-shaped sofa and a smaller two-seater with a footstool. With GROW, the choice is yours.

## GROW 2.0 – OUTDOOR-MÖBEL MIT UNENDLICHEN MÖGLICHKEITEN

Die vom deutschen Designerbüro kaschkasch entworfenen Loungermöbel werden vakuumiert und in versandfähigen Kartons geliefert. In nur 48 Stunden verwandeln sich die Module in eine gemütliche Outdoorlounge. GROW 2.0 bedarf weder eine Spedition noch eines fachkundigen Aufbauteams. Detaillierte Informationen entnehmen Sie bitte dem GROW Fact Sheet sowie dem Aufbauvideo.

Es kann jedoch zu leichten Formabweichungen der einzelnen Module kommen – wir verstehen jedes GROW Modul als ein Unikat. Die modularen Elemente lassen sich individuell kombinieren und bieten endlose Gestaltungsoptionen – getreu dem Namen GROW. Das flexible Design passt sich Ihren Bedürfnissen an. Sie können sowohl das klassische, familienfreundliche Sofa in L-Form als auch einen kleineren Zweisitzer mit Hocker kreieren. Mit GROW haben Sie die Wahl.

### GROW 62080

Protection Cover for Corner Seater Unit |  
 Schutzhülle für Ecksitzer Modul

Materials T3  
 Colour Light Gray  
 Features Can be tightened and adjusted with a cord; breathable and water-repellent. Umschließt mit Hilfe von Kordel und Stopper eng die Möbel; atmungsaktiv und wasserabweisend.

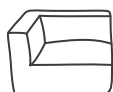

62080  
 for Corner Seater | für Ecksitzer



62081  
 for Single Seater | für 1-Sitzer

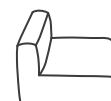

62082  
 for Double Seater | für 2-Sitzer

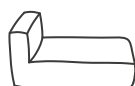

62083  
 for Ottoman | für Chaiselongue



62084  
 for Pouf | für Hocker



62292  
 for Armchair | für Sessel

Further information on the protective cover for the Lounger Chair can be found in the GROW Product Fact Sheet. Weitere Informationen zu der Schutzhülle für den Lounger Sessel finden Sie im GROW Product Fact Sheet.

**GROW 62107**

Corner Seater Unit Floor Plate |  
 Bodenplatte für Ecksitzer Modul  
 Dimensions H 2 cm, B 88 cm, T 89 cm  
 Materials H1, K3



**62107**  
 for Corner Seater **Unit 1** |  
 für Ecksitzer **Modul 1**



**62108**  
 for Single Seater **Unit 2** |  
 für 1-Sitzer **Modul 2**

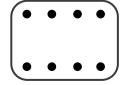

**62109**  
 for Double-Seater **Unit 3** |  
 für 2-Sitzer **Modul 3**

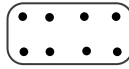

**62110**  
 for Ottoman **Unit 4** |  
 für Chaiselongue **Modul 4**



**62111**  
 for Pouf **Unit 5** |  
 für Hocker **Modul 5**



**GROW Floor Plate with case legs**

Each sofa unit gains additional stability by adding a custom fitting floor plate with case legs, also preventing soil wetness on the underside of the sofa. Simply slip the floor plate into the pouch and attach the case legs from the outside. Using furniture connectors you can easily join the sofa elements together to create a complete sofa combination.

To join the units together the matching floor plate and a set of furniture connectors per element are needed.

**GROW Bodenplatte mit Möbelfüßen**

Jedes Sofamodul kann durch eine passend konzipierte Bodenplatte mit Möbelfüßen zusätzliche Stabilität erlangen, womit auch Staunässe auf der Sofaunterseite vermieden wird. Hierbei wird die Platte in ein Zwischenfach eingeschoben und die Möbelfüße von außen angebracht. Durch die Verwendung von Möbelverbindern kann jedes Sofamodul kinderleicht miteinander verbunden und somit eine individuelle Sofalandschaft erstellt werden.



The QR code leads you to the GROW Product Fact Sheet and Assembly Video.  
 Der QR-Code führt Sie zu dem GROW Product Fact Sheet und Aufbauvideo.



**GROW 62106**

2 piece Unit Connector Set | Set 2 Möbelverbinder  
 Dimensions H 2 cm, B 4,5 cm, T 27,5 cm  
 Materials K3

Features The connectors are invisibly attached to the base plates and 2 pieces of furniture can then be snapped together: Safe and stable hold. A set of 2 furniture connectors is required for each Unit to be added.

Die Verbinder werden unsichtbar an die Bodenplatten angebracht und die Möbelstücke können dann rastend aneinander gerückt werden: Sicherer und stabiler Halt. Pro hinzuzufügendes Modul wird ein Set mit 2 Möbelverbindern benötigt.



**GROW 62113**

Set of 4 Case legs for Grow |  
 Set 4 Möbelfüße für Grow Modul  
 Dimensions H 3,5 cm, Ø 5 cm  
 Materials K3



GROW Unit Overview | Modul Übersicht

**M1**



**62240/62247 Unit | Modul 1:**  
Corner Seater Unit | Ecksitzer Modul  
Dimensions H 68 cm, B 95 cm, T 95 cm

**M2**



**62241/62248 Unit | Modul 2:**  
Single Seater Unit | 1-Sitzer Modul  
Dimensions H 68 cm, B 75 cm, T 95 cm

**M3**



**62244/62251 Unit | Modul 3:**  
Double Seater Unit | 2-Sitzer Modul  
Dimensions H 68 cm, B 130 cm, T 95 cm

**M4**



**62243/62250 Unit | Modul 4:**  
Ottoman Unit | Chaiselongue Modul  
Dimensions H 68 cm, B 75 cm, T 145 cm

**M5**



**62242/62249 Unit | Modul 5:**  
Pouf Unit | Hocker Modul  
Dimensions H 38 cm, B 75 cm, T 75 cm

Combinations and space requirements | Kombinationsmöglichkeiten und Platzbedarf

Combination | Beispiel A

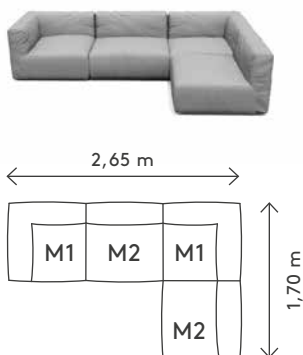

**2 x 62240/62247 M 1:**  
Corner Seater Unit | Ecksitzer Modul

**2 x 62241/62248 M 2:**  
Single Seater Unit | 1-Sitzer Modul

**3 x 62106 Connector Set | Möbelverbinder**  
**2 x 62107 Floor Plate | Bodenplatte**  
**2 x 62108 Floor Plate | Bodenplatte**

Combination | Beispiel B

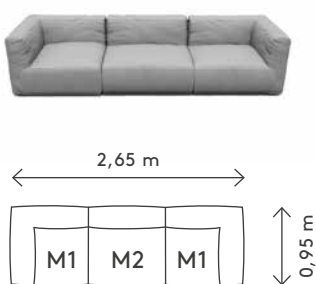

**2 x 62240/62247 M 1:**  
Corner Seater Unit | Ecksitzer Modul

**1 x 62241/62248 M 2:**  
Single Seater Unit | 1-Sitzer Modul

**2 x 62106 Connector Set | Möbelverbinder**  
**2 x 62107 Floor Plate | Bodenplatte**  
**1 x 62108 Floor Plate | Bodenplatte**

Combination | Beispiel C

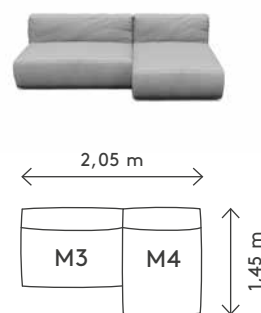

**1 x 62244/62251 M 3:**  
Double Seater Unit | 2-Sitzer Modul

**1 x 62243/62250 M 4:**  
Ottoman Unit | Chaiselongue Modul

**1 x 62106 Connector Set | Möbelverbinder**  
**1 x 62109 Floor Plate | Bodenplatte**  
**1 x 62110 Floor Plate | Bodenplatte**

Combination | Beispiel D

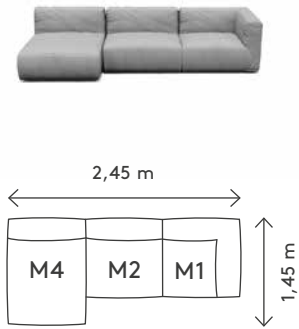

**1 x 62240/62247 M 1:**  
Corner Seater Unit | Ecksitzer Modul

**1 x 62241/62248 M 2:**  
Single Seater Unit | 1-Sitzer Modul

**1 x 62243/62250 M 4:**  
Ottoman Unit | Chaiselongue Modul

**2 x 62106** Connector Set | Möbelverbinder  
**1 x 62107** Floor Plate | Bodenplatte  
**1 x 62108** Floor Plate | Bodenplatte  
**1 x 62110** Floor Plate | Bodenplatte

Combination | Beispiel E

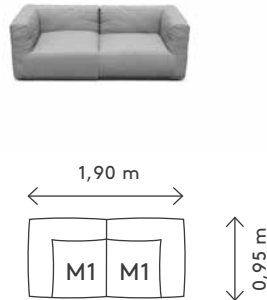

**2 x 62240/62247 M 1:**  
Corner Seater Unit | Ecksitzer Modul

**1 x 62106** Connector Set | Möbelverbinder  
**2 x 62107** Floor Plate | Bodenplatte

Combination | Beispiel F

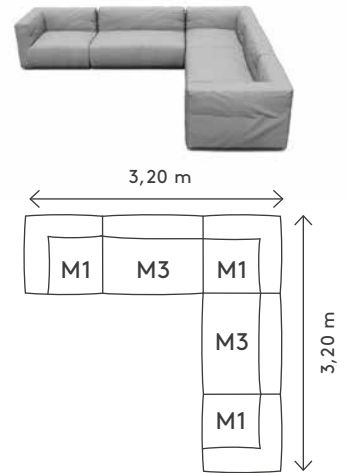

**3 x 62240/62247 M 1:**  
Corner Seater Unit | Ecksitzer Modul

**2 x 62244/62251 M 3:**  
Double Seater Unit | 2-Sitzer Modul

**4 x 62106** Connector Set | Möbelverbinder  
**3 x 62107** Floor Plate | Bodenplatte  
**2 x 62109** Floor Plate | Bodenplatte

Combination | Beispiel G

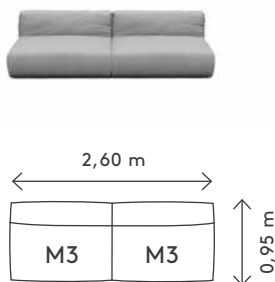

**2 x 62244/62251 M 3:**  
Double Seater Unit | 2-Sitzer Modul

**1 x 62106** Connector Set | Möbelverbinder  
**2 x 62109** Floor Plate | Bodenplatte

Combination | Beispiel H

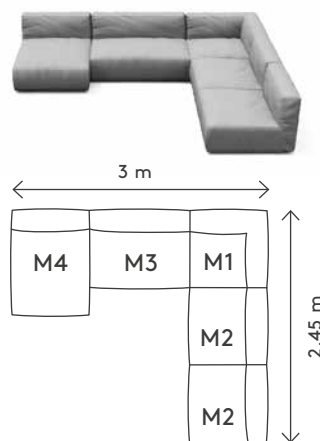

**1 x 62240/62247 M 1:**  
Corner Seater Unit | Ecksitzer Modul

**2 x 62241/62248 M 2:**  
Single Seater Unit | 1-Sitzer Modul

**1 x 62244/62251 M 3:**  
Double Seater Unit | 2-Sitzer Modul

**1 x 62243/62250 M 4:**  
Ottoman Unit | Chaiselongue Modul

**4 x 62106** Connector Set | Möbelverbinder  
**1 x 62107** Floor Plate | Bodenplatte  
**2 x 62108** Floor Plate | Bodenplatte  
**1 x 62109** Floor Plate | Bodenplatte  
**1 x 62110** Floor Plate | Bodenplatte

Combination | Beispiel I

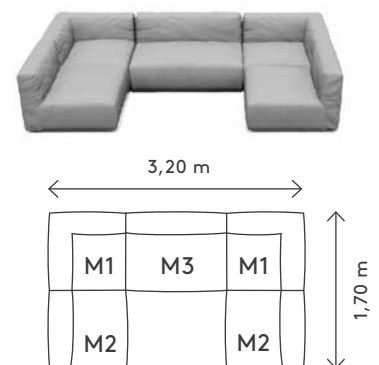

**2 x 62240/62247 M 1:**  
Corner Seater Unit | Ecksitzer Modul

**2 x 62241/62248 M 2:**  
Single Seater Unit | 1-Sitzer Modul

**1 x 62244/62251 M 3:**  
Double Seater Unit | 2-Sitzer Modul

**4 x 62106** Connector Set | Möbelverbinder  
**2 x 62107** Floor Plate | Bodenplatte  
**2 x 62108** Floor Plate | Bodenplatte  
**1 x 62109** Floor Plate | Bodenplatte



#### YUA / YUA WIRE

kaschkasch's approach to design a more formal garden furniture for blomus leads to a not too loud but still with it's own DNA in detail matching series. The main subject is the fine detail that the end of the flat surfaces is slightly drawn around the tubes of the main structure. These fine details on the edge and legs of the chairs and tables create the formal connection of the YUA family. kaschkasch has designed the YUA Series where you can choose from a variety of combinations: a classic Chair with and without armrests and a wider and more laid-back Lounger, both in flat steel - YUA - and wired seating options - YUA WIRE. Also, there is a Lounge Sofa in YUA WIRE version. You can combine these seating furniture perfectly with a large Dining Table, small Bistro Tables in round and rectangular shape as well as lower Lounge Tables in round and rectangular shape. All these options are available in a light Silk Gray and a darker Granite Gray.

#### YUA / YUA WIRE

kaschkasch's Ansatz, für blomus formale Gartenmöbel zu entwerfen, führt zu einer nicht zu lauten, aber dennoch mit eigener DNA und im Detail passenden Serie. Das Hauptthema, dass das Ende der flachen Flächen leicht um die Rohre der Hauptstreben gezogen ist, zieht sich durch die Designs der Stühle und Tische und schafft somit den formalen Zusammenhang der YUA-Familie. kaschkasch hat die Yua-Serie entworfen, bei der Sie aus einer Vielzahl von Kombinationen wählen können: Ein klassischer Stuhl mit und ohne Armlehnen und ein breiterer und entspannterer Lounger, beide in Flachstahl - YUA - und mit filigranen Metallstreben - YUA WIRE - erhältlich. Außerdem gibt es ein Loungesofa in YUA WIRE -Version. Sie können diese Sitzmöbel perfekt mit einem großen Esstisch, kleinen Bistrotischen in runder und rechteckiger Form sowie niedrigen Loungetischen in runder und rechteckiger Form kombinieren. Alle diese Varianten sind in einem hellen Silk Gray und einem dunkleren Granite Gray erhältlich.





**YUA 62171**

# Chair | Stuhl  
 Dimensions H 77 cm, B 55 cm, T 60 cm  
 Materials Sz, K3  
 Colour Silk Gray



62171  
Silk Gray



62174  
Granite Gray



**YUA WIRE 62177**

# Chair | Stuhl  
 Dimensions H 77 cm, B 55 cm, T 60 cm  
 Materials Sz, K3  
 Colour Silk Gray



62177  
Silk Gray



62180  
Granite Gray



**YUA 62172**

# Armchair | Armlehnstuhl  
 Dimensions H 77 cm, B 60 cm, T 60 cm  
 Materials Sz, K3  
 Colour Silk Gray



62172  
Silk Gray



62175  
Granite Gray



**YUA WIRE 62178**

# Armchair | Armlehnstuhl  
 Dimensions H 77 cm, B 60 cm, T 60 cm  
 Materials Sz, K3  
 Colour Silk Gray



62178  
Silk Gray



62181  
Granite Gray



**YUA 62173**

# Lounge Chair | Loungesessel  
 Dimensions H 66 cm, B 68 cm, T 72 cm  
 Materials Sz, K3  
 Colour Silk Gray



62173  
Silk Gray



62176  
Granite Gray



**YUA WIRE 62179**

# Lounge Chair | Loungesessel  
 Dimensions H 66 cm, B 68 cm, T 72 cm  
 Materials Sz, K3  
 Colour Silk Gray



62179  
Silk Gray



62182  
Granite Gray







**YUA WIRE 62183**

# Lounge Sofa | Loungesofa  
 Dimensions H 66 cm, B 134 cm, T 72 cm  
 Materials Sz, K3  
 Colour Silk Gray

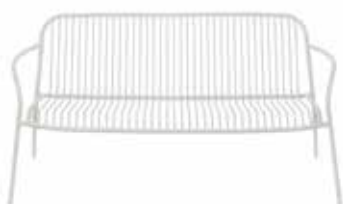

62183  
 Silk Gray



62184  
 Granite Gray

**YUA / YUA WIRE**

The YUA & YUA WIRE variants can be combined in various settings and wishes- they are a family and can be stacked as well as combined with each other in colour.

Die YUA & YUA WIRE-Varianten lassen sich in verschiedenen Settings und Wünschen zusammenstellen - sie sind eine Familie und können sowohl gestapelt als auch farblich miteinander kombiniert werden.



**YUA 62195**

Seat Pad | Sitzkissen  
 Dimensions H 2 cm, B 39 cm, T 34 cm  
 Materials T3  
 Colour Melange Gray  
 Features Suitable for Chair and Armchair  
 Geeignet für Stuhl und Armlehnstuhl



**YUA - GARDEN CUSHIONS**

The designer duo kaschkasch has developed the YUA outdoor cushions to perfectly match the YUA and YUA WIRE garden furniture. The cushions offer the ideal combination of style and comfort. The non-slip rear side and the high-quality, dense foam core guarantee pleasant cushioning and maximum comfort. Thanks to the water-repellent and weather-resistant material, the cushions are perfect for outdoor use. Moreover, the cushions are UV-resistant and easy to clean.

The Melange Gray shade combines the light nuances of Silk Gray with the dark tones of Granite Gray and thus offers a harmonious overall appearance of the YUA furniture. Available in matching sizes for every piece of seating furniture of the series.

**YUA - OUTDOORKISSEN**

Perfekt abgestimmt auf die YUA und YUA WIRE Gartenmöbel hat das Designerduo kaschkasch die YUA Outdoorkissen entwickelt. Die Kissen bieten die ideale Kombination aus Stil und Bequemlichkeit. Durch die rutschfeste Unterseite und den hochwertigen, dichten Schaumstoffkern werden eine angenehme Polsterung und maximaler Komfort garantiert. Dank dem wasserabweisenden und witterungsbeständigen Material eignen sich die Kissen perfekt für den Einsatz im Freien. Die Kissen sind zudem UV-beständig und pflegeleicht.

Der Farbton Melange Gray vereint die hellen Nuancen von Silk Gray mit den dunklen Tönen des Granite Gray und bietet damit ein harmonisches Gesamtbild der YUA Möbel. Erhältlich in den passenden Größen für jedes Sitzmöbelstück.



**YUA 62196**

Seat Pad | Sitzkissen  
 Dimensions H 2 cm, B 46 cm, T 41 cm  
 Materials T3  
 Colour Melange Gray  
 Features Suitable for Lounge Chair  
 Geeignet für Loungesessel



The QR code leads you to the YUA Product Fact Sheet.  
 Der QR-Code führt Sie zum YUA Product Fact Sheet.

**YUA 62197**

Seat Rest | Sitzauflage  
 Dimensions H 2 cm, B 39 cm, T 66 cm  
 Materials T3  
 Colour Melange Gray  
 Features Suitable for Chair and Armchair  
 Geeignet für Stuhl und Armlehnstuhl



**YUA 62198**

Seat Rest | Sitzauflage  
 Dimensions H 2 cm, B 46 cm, T 75 cm  
 Materials T3  
 Colour Melange Gray  
 Features Suitable for Lounge Chair  
 Geeignet für Loungesessel



**YUA 62199**

Seat Rest | Sitzauflage  
 Dimensions H 2 cm, B 111 cm, T 75 cm  
 Materials T3  
 Colour Melange Gray  
 Features Suitable for Lounge Sofa  
 Geeignet für Loungesofa





**YUA 31062**

Repair Kit | Reparatur-Set  
 Colour Silk Gray  
 Features Suitable for YUA Garden Furniture | Geeignet für YUA Gartenmöbel

NEW

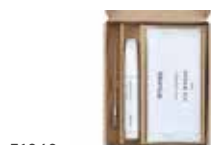

**31062**  
Silk Gray



**31063**  
Granite Gray

**YUA**

As for the material, blomus uses durable Steel that is galvanized and powder coated in an outdoor suitable high-end weatherproof coating, which presents itself very hard-wearing. In order to ensure long-lasting enjoyment of the furniture, we would recommend covering it during the winter. The YUA Repair Kits are available in the two YUA colours for repairing and touching up minor paint damage to your furniture. The kit contains a touch-up pen, a cleaning cloth, a wire brush and sandpaper.

Beim Material setzt blomus auf langlebigen Stahl, der galvanisiert und mit einer Outdoor-tauglichen High-End-Wetterschutzbeschichtung pulverbeschichtet wird, die sich sehr strapazierfähig präsentiert. Um lange Freude an den Möbeln zu haben, empfehlen wir, sie im Winter abzudecken. Für die Reparatur und Ausbesserung kleiner Lackschäden an Ihren Möbeln sind die YUA Reparatur-Sets in den beiden YUA Farben erhältlich. Das Set enthält einen Lackstift, ein Reinigungstuch, eine Drahtbürste und Schleifpapier.



**YUA 62189**

# Lounge Table | Loungetisch  
 Dimensions H 35 cm, Ø 80 cm  
 Materials Sz, K3  
 Colour Silk Gray



**YUA 62188**

# Lounge Table | Loungetisch  
 Dimensions H 35 cm, B 80 cm, T 80 cm  
 Materials Sz, K3  
 Colour Silk Gray



**YUA 62187**

# Bistro Table | Bistrotisch  
 Dimensions H 74 cm, Ø 80 cm  
 Materials Sz, K3  
 Colour Silk Gray



**YUA 62186**

# Bistro Table | Bistrotisch  
 Dimensions H 74 cm, B 80 cm, T 80 cm  
 Materials Sz, K3  
 Colour Silk Gray



**YUA 62185**

# Dining Table | Esstisch  
 Dimensions H 74 cm, B 180 cm, T 90 cm  
 Materials Sz, K3  
 Colour Silk Gray



**YUA 62190**

# Dining Table | Esstisch  
 Dimensions H 74 cm, B 180 cm, T 90 cm  
 Materials Sz, K3  
 Colour Granite Gray





**KAPET OUTDOOR RUG**

Whether indoors or outdoors, the hand-woven KAPET rug provides structure and comfort. Made from recycled PET yarn, it is robust and weatherproof, yet pleasantly soft to the touch.

A rug that combines function and warmth and is at home anywhere.

**KAPET OUTDOOR TEPPICH**

Ob drinnen oder draußen – der handgewebte Teppich KAPET schenkt Struktur und Geborgenheit. Aus recyceltem PET-Garn gefertigt, ist er robust und wetterfest, zugleich angenehm weich im Griff.

Ein Teppich, der Funktion und Wärme vereint und überall zuhause ist.

**KAPET 62302**

# Outdoor Rug | Outdoor Teppich  
 Dimensions B 80 cm, T 200 cm  
 Materials K3r (recycled PET)  
 Colour Beige Melange  
 Features Flor Height: ca. 0,7 cm  
 Florhöhe: ca. 0,7 cm, Size: S

NEW



**KAPET 62303**

# Outdoor Rug | Outdoor Teppich  
 Dimensions B 140 cm, T 200 cm  
 Materials K3r (recycled PET)  
 Colour Beige Melange  
 Features Flor Height: ca. 0,7 cm  
 Florhöhe: ca. 0,7 cm, Size: M

NEW



**KAPET 62304**

# Outdoor Rug | Outdoor Teppich  
 Dimensions B 200 cm, T 300 cm  
 Materials K3r (recycled PET)  
 Colour Beige Melange  
 Features Flor Height: ca. 0,7 cm  
 Florhöhe: ca. 0,7 cm, Size: L

NEW



**KAPET 62305**

# Outdoor Rug | Outdoor Teppich  
 Dimensions B 80 cm, T 200 cm  
 Materials K3r (recycled PET)  
 Colour Cloud Melange  
 Features Flor Height: ca. 0,7 cm  
 Florhöhe: ca. 0,7 cm, Size: S

NEW



**KAPET 62306**

# Outdoor Rug | Outdoor Teppich  
 Dimensions B 140 cm, T 200 cm  
 Materials K3r (recycled PET)  
 Colour Cloud Melange  
 Features Flor Height: ca. 0,7 cm  
 Florhöhe: ca. 0,7 cm, Size: M

NEW



**KAPET 62307**

# Outdoor Rug | Outdoor Teppich  
 Dimensions B 200 cm, T 300 cm  
 Materials K3r (recycled PET)  
 Colour Cloud Melange  
 Features Flor Height: ca. 0,7 cm  
 Florhöhe: ca. 0,7 cm, Size: L

NEW



**KAPET 62308**

# Outdoor Rug | Outdoor Teppich  
 Dimensions B 80 cm, T 200 cm  
 Materials K3r (recycled PET)  
 Colour Zinc Melange  
 Features Flor Height: ca. 0,7 cm  
 Florhöhe: ca. 0,7 cm, Size: S

NEW



**KAPET 62309**

# Outdoor Rug | Outdoor Teppich  
 Dimensions B 140 cm, T 200 cm  
 Materials K3r (recycled PET)  
 Colour Zinc Melange  
 Features Flor Height: ca. 0,7 cm  
 Florhöhe: ca. 0,7 cm, Size: M

NEW



**KAPET 62310**

# Outdoor Rug | Outdoor Teppich  
 Dimensions B 200 cm, T 300 cm  
 Materials K3r (recycled PET)  
 Colour Zinc Melange  
 Features Flor Height: ca. 0,7 cm  
 Florhöhe: ca. 0,7 cm, Size: L

NEW





## OUTDOOR ESSENTIALS

### TENDOR 62269

# Outdoor Rug | Outdoor Teppich  
 Dimensions B 80 cm, T 200 cm  
 Materials K3  
 Colour Beige Melange  
 Features Standard 100 by OEKO-TEX®,  
 Flor Height: ca. 1,5 cm,  
 Florhöhe: ca. 1,5 cm, Size: S



62269  
Beige Melange



62270  
Zinc Melange



62271  
Cloud Melange

### TENDOR 62272

# Outdoor Rug | Outdoor Teppich  
 Dimensions B 140 cm, T 200cm  
 Materials K3  
 Colour Beige Melange  
 Features Standard 100 by OEKO-TEX®,  
 Flor Height: ca. 1,5 cm,  
 Florhöhe: ca. 1,5 cm, Size: M



62272  
Beige Melange



62273  
Zinc Melange



62274  
Cloud Melange

### TENDOR 62275

# Outdoor Rug | Outdoor Teppich  
 Dimensions B 200 cm, T 300cm  
 Materials K3  
 Colour Beige Melange  
 Features Standard 100 by OEKO-TEX®,  
 Flor Height: ca. 1,5 cm,  
 Florhöhe: ca. 1,5 cm, Size: L



62275  
Beige Melange



62276  
Zinc Melange



62277  
Cloud Melange

### TENDOR OUTDOOR RUG

Transform your outdoor area into a pure oasis of well-being with our new TENDOR outdoor rug. Made in India from 100% PET, TENDOR not only impresses with its melange look and texture, but also with its unique feel.

Available in three different colours and sizes (80x200 cm, 140x200 cm, 200x300 cm), TENDOR brings a touch of cosiness to your garden.

### TENDOR OUTDOOR TEPPICH

Verwandeln Sie Ihren Außenbereich mit unserem neuen Outdoorteppich TENDOR zu einer reinen Wohlfühl-Oase. Hergestellt in Indien aus 100% PET, besticht TENDOR nicht nur durch seine Melangeoptik und Struktur, sondern auch durch seine einzigartige Haptik.

Erhältlich in drei verschiedenen Farben und Größen (80x200 cm, 140x200 cm, 200x300 cm) bringt TENDOR ein Stück Wohnlichkeit in Ihren Garten.





**KIVA 62162**

# Outdoor Rug | Outdoor Teppich  
 Dimensions B 80 cm, T 200 cm  
 Materials K3r (recycled PET)  
 Colour Beige Melange  
 Features Made from recycled PET Bottles, Flor Height: ca. 0,5 cm  
 Hergestellt aus recycelten PET-Flaschen, Florhöhe: ca. 0,5 cm, Size: S



62162  
Beige Melange



62165  
Zinc Melange



62168  
Cloud Melange

**KIVA 62163**

# Outdoor Rug | Outdoor Teppich  
 Dimensions B 140 cm, T 200 cm  
 Materials K3r (recycled PET)  
 Colour Beige Melange  
 Features Made from recycled PET Bottles, Flor Height: ca. 0,5 cm  
 Hergestellt aus recycelten PET-Flaschen, Florhöhe: ca. 0,5 cm, Size: M



62163  
Beige Melange



62166  
Zinc Melange



62169  
Cloud Melange

**KIVA 62164**

# Outdoor Rug | Outdoor Teppich  
 Dimensions B 200 cm, T 300 cm  
 Materials K3r (recycled PET)  
 Colour Beige Melange  
 Features Made from recycled PET Bottles, Flor Height: ca. 0,5 cm  
 Hergestellt aus recycelten PET-Flaschen, Florhöhe: ca. 0,5 cm, Size: L



62164  
Beige Melange



62167  
Zinc Melange



62170  
Cloud Melange



**KIVA OUTDOOR RUG**

Bring the cosiness of your living room into your garden! The KIVA outdoor rug is made of easy-care and robust polypropylene, which is ideal for indoor and outdoor use. The fabric consists of recycled PET bottles. Depending on the rug size, between 640 and 2400 bottles are processed. The open weave allows air to circulate, so the rug dries quickly and is insensitive to moisture. A damp cloth and light detergent are suitable for cleaning. You can also use a garden hose to remove stubborn stains. The best way to dry the rug is to leave it in the sun, because thanks to its UV resistance the outdoor rug can withstand different kinds of weather conditions without any problems. In addition, the material is OEKOTEX®-certified, which guarantees a sustainable production chain and responsible use of resources.

**KIVA OUTDOOR TEPPICH**

Bringen Sie die Gemütlichkeit Ihres Wohnzimmers in Ihren Garten! Der KIVA Outdoor Teppich besteht aus pflegeleichtem und robustem Polypropylen, welches sich hervorragend für die Nutzung in Innen- und Außenräumen eignet. Das Gewebe besteht aus recycelten PET-Flaschen. Je nach Teppichgröße sind zwischen 640 und 2400 Flaschen verarbeitet. Durch eine offene Webart kann die Luft zirkulieren, sodass der Teppich schnell trocknet und unempfindlich gegen Nässe ist. Zur Reinigung eignet sich ein feuchtes Tuch und leichtes Reinigungsmittel. Bei hartnäckigen Verschmutzungen können die betroffenen Stellen auch mit einem Gartenschlauch gereinigt werden. Danach trocknet der Teppich am besten in der Sonne, denn dank der UV-Beständigkeit hält der Outdoorteppich verschiedenen Witterungen problemlos stand. Zudem ist das Material OEKOTEX®-zertifiziert, was eine nachhaltige Produktionskette und einen verantwortungsbewussten Umgang mit Ressourcen garantiert.

# Pallet delivery only. Nur Palettenversand.





**SANAKA 67482**

Mobile LED Lamp | Mobile LED-Leuchte  
 Dimensions H 18,5 cm, B 17 cm, T 17 cm  
 Materials K3r  
 Colour White  
 Features 1 light colour, infinitely dimmable  
 1 Lichtfarbe, stufenlos dimmbar

NEW



**SANAKA**

In-/Outdoor use   In-/Outdoorbenutzung	
Battery operated   Akkubetrieb	
Charging dock   Stationsladung	
Operation time   Brenndauer:	<b>8.5-42.5 h</b>
Luminous flux   Lichtstrom:	<b>170 lm</b>
Output   Leistung:	<b>1.5 W</b>
Voltage   Spannung:	<b>DC 3.7 V</b>
Protection class   Schutzklasse:	<b>III</b>
Water tightness   Wasserdichtigkeit:	<b>IP 54</b>
Luminous colour   Lichtfarbe:	<b>2700K</b>
Input:	<b>DC5V/1A</b>
Charging Time   Ladezeit:	<b>4 h</b>

**SANAKA – DESIGN BY THERESA RAND**

The SANAKA outdoor lamp by Theresa Rand translates the art of origami into light. Made from recycled polycarbonate, it is reminiscent of small Japanese houses. Robust yet delicate in appearance, it satisfies the longing for faraway places and brings a touch of Japanese poetry to outdoor spaces.

**SANAKA – DESIGN VON THERESA RAND**

Die SANAKA Outdoorleuchte von Theresa Rand übersetzt die Kunst des Origami in Licht. Aus recyceltem Polycarbonat gefertigt, erinnert sie an kleine japanische Häuser. Robust und doch zart anmutend, stillt sie die Sehnsucht nach Ferne und bringt einen Hauch japanischer Poesie in den Außenbereich.

**FAWN 62290**

Mobile LED Lamp | Mobile LED Leuchte  
 Dimensions H 13,5 cm, Ø 12,5 cm  
 Materials Gs, Ab, K3, K4  
 Colour Silk Gray  
 Features 3 light colours, infinitely dimmable  
 3 Lichtfarben, stufenlos dimmbar



**FAWN**

In-/Outdoor use   In-/Outdoorbenutzung	
Battery operated   Akkubetrieb	
USB-C Charging   USB-C Aufladung	
Operation time   Brenndauer:	7-35 h
Luminous flux   Lichtstrom:	110 lm
Output   Leistung:	1 W
Voltage   Spannung:	DC 3.7 V
Protection class   Schutzklasse:	III
Water tightness   Wasserdichtigkeit:	IP 54
Luminous colour   Lichtfarbe:	2700-4000K
Input:	DC5V/1A
Charging Time   Ladezeit:	2.5 h



**FAWN – DESIGN BY ADAM MILLER**

The FAWN luminaire by designer Adam Miller is designed for indoor and outdoor use and emits a soft light everywhere. The luminaire body is made of matt opal glass and provides diffuse light refraction, reminiscent of a foggy morning. The head is made of aluminium and provides an exciting contrast to the frosted glass shape. The FAWN luminaire is named after the warm glow and serenity of nature and brings this balance into your home. Three light colours can be dimmed individually and the energy-saving LED ensures a long service life.

**FAWN – DESIGN VON ADAM MILLER**

Die FAWN Leuchte des Designers Adam Miller ist für den Innen- und Außenbereich konzipiert und verströmt überall ein sanftes Licht. Der Leuchtenkörper ist aus mattem Opalglas hergestellt und sorgt für eine diffuse Lichtbrechung, die an einen nebeligen Morgen erinnern. Der Kopf ist aus Aluminium hergestellt und bietet einen spannenden Gegensatz zu der mattierten Glasform. Die Leuchte FAWN ist nach dem warmen Glanz und der Gelassenheit der Natur benannt und bringt diese Ausgeglichenheit in Ihr Zuhause. Drei Lichtfarben lassen sich individuell stufenlos dimmen und die energiesparende LED sorgt für eine lange Lebensdauer.

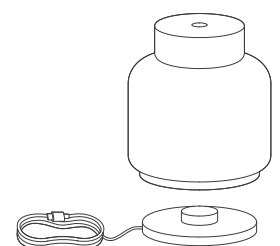

**MITURO 62104**

Mobile LED Lamp | Mobile LED-Leuchte  
 Dimensions H 35 cm, Ø 17 cm  
 Materials Ab, Gf  
 Colour Gunmetal, metallic finish  
 Features Size: S



**MITURO 62105**

Mobile LED Lamp | Mobile LED-Leuchte  
 Dimensions H 45 cm, Ø 17 cm  
 Materials Ab, Gf  
 Colour Gunmetal, metallic finish  
 Features Size: M



**MITURO S**

In-/Outdoor use | In-/Outdoorbenutzung

Battery operated | Akkubetrieb

Magnetic charging | Magnetladung

Operation time   Brenndauer:	<b>6-30 h</b>
Luminous flux   Lichtstrom:	<b>280 lm</b>
Output   Leistung:	<b>3 W</b>
Voltage   Spannung:	<b>DC 3.7 V</b>
Protection class   Schutzklasse:	<b>III</b>
Water tightness   Wasserdichtigkeit:	<b>IP 54</b>
Luminous colour   Lichtfarbe:	<b>2700-4000K</b>
Input	<b>5V/2A</b>
Charging Time   Ladezeit:	<b>3-5.5 h</b>

**MITURO M**

In-/Outdoor use | In-/Outdoorbenutzung

Battery operated | Akkubetrieb

Magnetic charging | Magnetladung

Operation time   Brenndauer:	<b>5.5-27 h</b>
Luminous flux   Lichtstrom:	<b>178 lm</b>
Output   Leistung:	<b>5 W</b>
Voltage   Spannung:	<b>DC 3.7 V</b>
Protection class   Schutzklasse:	<b>III</b>
Water tightness   Wasserdichtigkeit:	<b>IP 54</b>
Luminous colour   Lichtfarbe:	<b>3000K</b>
Input:	<b>5V/2A</b>
Charging Time   Ladezeit:	<b>4.5-8.5 h</b>

**IS IT POSSIBLE TO CAPTURE LIGHT?**

The MITURO luminaire designed by Peter Lienhart seems to make this a reality. An aluminium body encloses a darkened glass tube in which the light is held. At the same time, an atmospheric all-round light is emitted. The integrated, discreet handle also makes it easy to carry.

Functionality is also the focus when it comes to charging: thanks to a magnetic connection, a quick connection for charging is possible without having to look for very long. Whether preset or infinitely variable, different levels of brightness can be set via the touch button on the top of the lamp.

Due to the high water resistance of IP54, the luminaire can be used indoors and outdoors.



**IST ES MÖGLICH, LICHT EINZUFANGEN?**

Die von Peter Lienhart designte Leuchte MITURO scheint dies zu verwirklichen. Ein Korpus aus Aluminium umfasst hierbei eine verdunkelte Glasröhre, in der das Licht gehalten wird. Zugleich wird ein atmosphärisches Rundumlicht abgegeben. Mit Hilfe des integrierten, dezenten Griffs wird überdies ein leichtes Tragen ermöglicht.

Funktionalität steht auch bei der Aufladung im Fokus: Durch einen Magnetanschluss ist ein schnelles Verbinden zur Aufladung ohne langes Suchen möglich. Ob voreingestellt oder stufenlos, über den Berührungsknopf auf der Oberseite der Leuchte können verschiedene Helligkeiten eingestellt werden.

Aufgrund der hohen Wasserdichtigkeit von IP54 ist eine Verwendung der Leuchte drinnen und draußen möglich.





## OUTDOOR ESSENTIALS

### LITO LED LAMP

The mobile LITO lamp creates new standards. Enjoy the magical mood lighting of our popular LITO lanterns also outdoors. The classic design details are complemented by an LED head that illuminates your garden in three different spectral colours, depending on your preference. The lamp is rechargeable and will light up some cosy barbecue evenings with friends, as it has a long operation time. Simply touch the button on the top, choose your desired spectral colour, dim up to your desired light intensity and get enchanted by the wonderful lightness of LITO LED. The outdoor LED is rechargeable via a USB-C connection and can be adjusted between the three light colours warm white, mix and cool white. The bulb is not replaceable, but thanks to the LED has an extremely long life of over 20,000 hours.

### LITO LED LEUCHE

Die mobile LITO Leuchte schafft neue Maßstäbe. Genießen Sie die magische Lichtstimmung unserer beliebten LITO Laternen auch im Außenbereich. Die klassischen Designdetails werden mit einem LED Kopf ergänzt, der Ihren Garten je nach Wunsch in drei verschiedene Lichtfarben taucht. Die Leuchte ist aufladbar und erhellt dank einer langen Betriebszeit einige gemütliche Grillabende mit Freunden. Berühren Sie einfach den Touch Button auf der Oberseite, wählen Sie Ihre gewünschte Lichtfarbe, dimmen Sie bis zu Ihrer gewünschten Lichtstärke und lassen Sie sich von der wundervollen Leichtigkeit der LITO LED verzaubern. Die Outdoor LED ist über einen USB-C-Anschluss aufladbar und kann zwischen den drei Lichtfarben Warmweiß, Mix und Kaltweiß eingestellt werden. Das Leuchtmittel ist nicht austauschbar, hat aber dank der LED eine extrem lange Lebensdauer von über 20.000 Stunden.



### LITO LED 67477

Mobile LED Lamp | Mobile LED-Leuchte

Dimensions H 12 cm, Ø 13,5 cm

Materials Ab, Sb, K4

Colour White

Features 3 light colours, infinitely dimmable  
3 Lichtfarben, stufenlos dimmbar,  
Size: XS

NEW



67477  
White



67478  
Mourning Dove



67476  
Black



67479  
Nomad



**LITO LED 67052**

Mobile LED Lamp | Mobile LED Leuchte

Dimensions H 30,5 cm, Ø 27,5 cm

Materials Ab, Sb

Colour Silk Gray

Features 3 light colours, infinitely dimmable | 3 Lichtfarben, stufenlos dimmbar, Size: M

67052  
Silk Gray



67053  
Granite Gray



67054  
Black



**LITO LED 67055**

Mobile LED Lamp | Mobile LED Leuchte

Dimensions H 49 cm, Ø 31 cm

Materials Ab, Sb

Colour Silk Gray

Features 3 light colours, infinitely dimmable | 3 Lichtfarben, stufenlos dimmbar, Size:L

67055  
Silk Gray



67056  
Granite Gray



67057  
Black



**LITO LED M**

In-/Outdoor use | In-/Outdoorbenutzung

Battery operated | Akkubetrieb

USB-C Charging | USB-C Aufladung

Operation time | Brenndauer: 12-60 h

Luminous flux | Lichtstrom: 100 lm

Output | Leistung: 1.2 W

Voltage | Spannung: DC 3.7 V

Protection class | Schutzklasse: III

Water tightness | Wasserdichtigkeit: IP 54

Luminous colour | Lichtfarbe: 2700-4000K

Input: DC5V/1A

Charging Time | Ladezeit: 4.5 h

**LITO LED L**

In-/Outdoor use | In-/Outdoorbenutzung

Battery operated | Akkubetrieb

USB-C Charging | USB-C Aufladung

Operation time | Brenndauer: 9.5-47.5 h

Luminous flux | Lichtstrom: 130 lm

Output | Leistung: 1.5 W

Voltage | Spannung: DC 3.7 V

Protection class | Schutzklasse: III

Water tightness | Wasserdichtigkeit: IP 54

Luminous colour | Lichtfarbe: 2700-4000K

Input: DC5V/1A

Charging Time | Ladezeit: 4.5 h

**LITO LED XS**

In-/Outdoor use | In-/Outdoorbenutzung

Battery operated | Akkubetrieb

USB-C Charging | USB-C Aufladung

Operation time | Brenndauer: 7-35 h

Luminous flux | Lichtstrom: 140 lm

Output | Leistung: 1 W

Voltage | Spannung: DC 3.7 V

Protection class | Schutzklasse: III

Water tightness | Wasserdichtigkeit: IP 54

Luminous colour | Lichtfarbe: 2700-4000K

Input: DC5V/1A

Charging Time | Ladezeit: 2.5 h





## OUTDOOR ESSENTIALS

### IRIS 67043

Mobile LED Lamp | Mobile LED-Leuchte  
 Dimensions H 18 cm, Ø 10 cm  
 Materials Gf, Adm  
 Colour Gun Metal, metallic finish  
 Features 3 light colours, infinitely dimmable  
 3 Lichtfarben, stufenlos dimmbar



### IRIS 67045

Mobile LED Lamp | Mobile LED-Leuchte  
 Dimensions H 18 cm, Ø 10 cm  
 Materials Gf, Adm  
 Colour Metallic finish  
 Features 3 light colours, infinitely dimmable  
 3 Lichtfarben, stufenlos dimmbar



### IRIS

In-/Outdoor use | In-/Outdoorbenutzung

Battery operated | Akkubetrieb

Charging dock | Stationsladung

Operation time | Brenndauer: 4.5-47.5 h

Luminous flux | Lichtstrom: 115 lm

Output | Leistung: 1.5 W

Voltage | Spannung: DC 3.7 V

Protection class | Schutzklasse: III

Water tightness | Wasserdichtigkeit: IP 54

Luminous colour | Lichtfarbe: 2700-4000K

Input: DC5V/1A

Charging Time | Ladezeit: 4.5 h



### 67261 CHARGING STATION

Charging Station 6 in 1 | Stationsladung 6 in 1

Dimensions H 4 cm, B 29 cm, T 47 cm

Materials K3

Colour Black

Features Charging for all mobile LED lamps, indoor use only, integrated on and off switch

Ladung für alle mobilen LED-Leuchten, Indoornutzung, integrierter An- und Ausschalter mit Netzbetrieb



Our 6 in 1 charging station is perfect to charge all lamps that are compatible with the flat, round charging station. Whether all lamps of the same product line or a colourful mix of all – six lamps can be efficiently charged together. The charging station is for indoor use only. The integrated switch allows the charging station to be switched on and off as desired.

Unsere 6 in 1 Ladestation eignet sich perfekt für die Ladung aller Leuchten, die mit der flachen, runden Ladestation geladen werden. Ob alle Leuchten der gleichen Serie oder ein bunter Mix von allen – sechs Leuchten können gemeinsam effizient geladen werden. Die Ladestation ist nur im Indoorbereich nutzbar. Durch den integrierten Schalter kann die Ladestation nach Belieben ein- und ausgeschaltet werden.

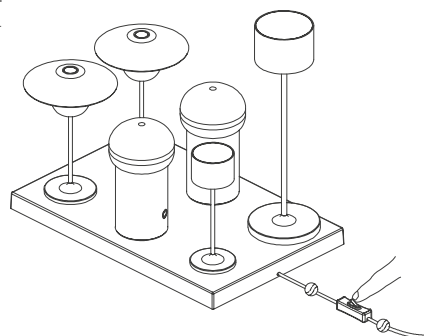



**WHERE ELEGANCE MEETS INNOVATION – IRIS**

The LED lamp is designed by Sebastian Herkner. The durable glass shade with visible bubbles and elegant aluminium base seamlessly combines beauty and functionality, making it perfect for both indoor and outdoor use. With a simple touch, IRIS comes to life, offering you a choice of three light tones that can be dimmed to your preference with a gentle, longer touch. IRIS recharges effortlessly with the included charging base while remaining functional. Burn time: 9 - 47 hours, splash proof. Available in several colours.

**WO ELEGANZ AUF INNOVATION TRIFFT – IRIS**

Entworfen wurde die LED-Leuchte von Sebastian Herkner. Der robuste Glasschirm mit den sichtbaren Bläschen und die elegante Aluminiumbasis verbinden Schönheit und Funktionalität nahtlos und machen sie perfekt für den Einsatz sowohl im Innen- als auch im Außenbereich. Mit einer einfachen Berührung des Knopfes erwacht IRIS zum Leben und bietet Ihnen die Wahl zwischen drei Lichttönen, die durch eine sanfte, längere Berührung nach Ihren Vorlieben gedimmt werden können. IRIS lässt sich mühelos mit der mitgelieferten Ladestation aufladen, während sie weiterhin funktionsfähig bleibt. Brenndauer: 9 - 47 Stunden, spritzwassergeschützt. In mehreren Farben erhältlich.



**FAROL MINI 67046**

Mobile LED Lamp | Mobile LED-Leuchte  
 Dimensions H 19,5 cm, Ø 7 cm  
 Materials Ab, K3, K4  
 Colour White  
 Features 3 light colours, infinitely dimmable,  
 3 Lichtfarben, stufenlos dimmbar



**FAROL MINI 67047**

Mobile LED Lamp | Mobile LED-Leuchte  
 Dimensions H 19,5 cm, Ø 7 cm  
 Materials Ab, K3, K4  
 Colour Satellite  
 Features 3 light colours, infinitely dimmable,  
 3 Lichtfarben, stufenlos dimmbar



**FAROL MINI 67048**

Mobile LED Lamp | Mobile LED-Leuchte  
 Dimensions H 19,5 cm, Ø 7 cm  
 Materials Ab, K3, K4  
 Colour Warm Gray  
 Features 3 light colours, infinitely dimmable,  
 3 Lichtfarben, stufenlos dimmbar



**FAROL MINI 67049**

Mobile LED Lamp | Mobile LED-Leuchte  
 Dimensions H 19,5 cm, Ø 7 cm  
 Materials Ab, K3, K4  
 Colour Gun Metal, metallic finish  
 Features 3 light colours, infinitely dimmable,  
 3 Lichtfarben, stufenlos dimmbar



**FAROL MINI 67050**

Mobile LED Lamp | Mobile LED-Leuchte  
 Dimensions H 19,5 cm, Ø 7 cm  
 Materials Ab, K3, K4  
 Colour Burned Metal, metallic finish  
 Features 3 light colours, infinitely dimmable,  
 3 Lichtfarben, stufenlos dimmbar



**FAROL MINI LAMP**

FAROL MINI is a statement. Perfect for indoor and outdoor use, this elegant lamp sets new standards. With its intuitive design, FAROL MINI can be activated with a gentle touch in the centre and illuminates your surroundings with three shades of light. From warm ambience to bright sparkle, choose from different light levels and adjust the brightness simply by holding. FAROL MINI charges effortlessly through the included charging station and is functional even while charging. It is available in several colours as well as other sizes. Charge lasts 7-35 hours, splash-proof.

**FAROL MINI LEUCHE**

Die FAROL MINI ist ein Statement. Perfekt für den Einsatz im Innen- und Außenbereich, setzt diese elegante Leuchte neue Maßstäbe. Mit ihrem intuitiven Design lässt sich die FAROL MINI durch eine sanfte Berührung in der Mitte aktivieren und erhellt Ihre Umgebung mit drei Lichttönen. Von warmem Ambiente bis hin zu hellem Funkeln - wählen Sie aus verschiedenen Lichtstufen und passen Sie die Helligkeit durch simples Halten an. Die FAROL MINI wird mühelos durch die beigefügte Ladestation aufgeladen und ist auch während der Ladung funktionsfähig. Sie ist in mehreren Farben sowie in weiteren Größen erhältlich. Brenndauer: 7-35 Stunden, spritzwassergeschützt.

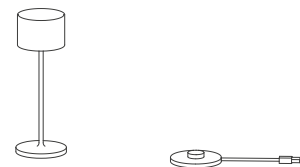

H 1,15 m

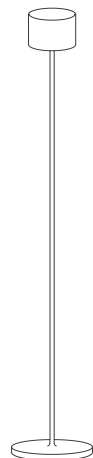

FLOOR

H 33,5cm



H 19,5 cm



MINI

**FAROL MINI**

In-/Outdoor use   In-/Outdoorbenutzung	
Battery operated   Akkubetrieb	
Charging dock   Stationsladung	
Operation time   Brenndauer:	7-35 h
Luminous flux   Lichtstrom:	90 lm
Output   Leistung:	1 W
Voltage   Spannung:	DC 3.7 V
Protection class   Schutzklasse:	III
Water tightness   Wasserdichtigkeit:	IP 54
Luminous colour   Lichtfarbe:	2700-4000K
Input:	DC5V/1A
Charging Time   Ladezeit:	2.5 h



## OUTDOOR ESSENTIALS

### FAROL 66725

Mobile LED Lamp | Mobile LED-Leuchte  
 Dimensions H 35,5 cm, Ø 11 cm  
 Materials Ab, K3  
 Colour Rusty Look



### FAROL

In-/Outdoor use   In-/Outdoorbenutzung	
Battery operated   Akkubetrieb	
Charging dock   Stationsladung	
Operation time   Brenndauer:	<b>9.5-47.5 h</b>
Luminous flux   Lichtstrom:	<b>130 lm</b>
Output   Leistung:	<b>1.5 W</b>
Voltage   Spannung:	<b>DC 3.7 V</b>
Protection class   Schutzklasse:	<b>III</b>
Water tightness   Wasserdichtigkeit:	<b>IP 54</b>
Luminous colour   Lichtfarbe:	<b>2700-4000K</b>
Input:	<b>5V/DC 1A</b>
Charging Time   Ladezeit:	<b>4.5 h</b>

### FAROL FLOOR 66127-66129

In-/Outdoor use   In-/Outdoorbenutzung	
Battery operated   Akkubetrieb	
Magnetic charging   Magnetladung	
Operation time   Brenndauer:	<b>9.5-47.5 h</b>
Luminous flux   Lichtstrom:	<b>130 lm</b>
Output   Leistung:	<b>1.5 W</b>
Voltage   Spannung:	<b>DC 3.7 V</b>
Protection class   Schutzklasse:	<b>III</b>
Water tightness   Wasserdichtigkeit:	<b>IP 54</b>
Luminous colour   Lichtfarbe:	<b>2700-4000K</b>
Input:	<b>5V/DC 1A</b>
Charging Time   Ladezeit:	<b>4.5 h</b>

### FAROL 66124

Mobile LED Lamp | Mobile LED-Leuchte  
 Dimensions H 33,5 cm, Ø 11 cm  
 Materials Ab, K3  
 Colour White  
 Features 3 light colours, infinitely dimmable  
 3 Lichtfarben, stufenlos dimmbar



66124  
White



66125  
Satellite



66126  
Warm Gray



66215  
Gunmetal, metallic finish



66216  
Burned Metal, metallic finish



### 3 BRIGHTNESS LEVELS, DIMMABLE AND SUITABLE FOR OUTDOOR USE

Thanks to the integrated rechargeable battery FAROL is particularly versatile in both indoor and outdoor use. Even heavy rain cannot harm the lamp due to its high level of water resistance. The lamp is operated by touching the center point on the lampshade. In this way, three brightness levels and the switching on and off of the lamp can be controlled. An additional dimming function enables further brightness settings, so that different lighting moods can be provided.

The battery is charged through a simple charging dock. The red or green light colour indicates the charging process.

### 3 HELBIGKEITSTUFEN, DIMMFUNKTION UND OUTDOORGEEIGNET

Dank des integrierten Akkus ist FAROL sowohl im Indoor- sowie Outdoorbereich besonders vielseitig einsetzbar. Auch starker Regen kann der Leuchte aufgrund des Spritzwasserschutzes nichts anhaben. Bedient wird die Leuchte durch ein kurzes Berühren des Mittelpunktes auf dem Lampenschirm. So lassen sich drei Helligkeitsstufen, sowie das Ein- und Ausschalten der Leuchte steuern. Eine zusätzliche Dimmfunktion ermöglicht weitere Helligkeitseinstellungen, sodass für verschiedene Lichtstimmungen gesorgt werden kann.

Zum Aufladen wird die FAROL Leuchte über eine Ladestation geladen. Dabei zeigt die rote bzw grüne Lichtfarbe den Ladevorgang an.

**FAROL FLOOR 66127**

Mobile LED Lamp | Mobile LED-Leuchte  
 Dimensions H 115 cm, Ø 15 cm  
 Materials Ab, K3  
 Colour White  
 Features 3 light colours, infinitely dimmable  
 3 Lichtfarben, stufenlos dimmbar



**FAROL FLOOR 66128**

Mobile LED Lamp | Mobile LED-Leuchte.  
 Dimensions H 115 cm, Ø 15 cm  
 Materials Ab, K3  
 Colour Satellite  
 Features 3 light colours, infinitely dimmable  
 3 Lichtfarben, stufenlos dimmbar



**FAROL FLOOR 66129**

Mobile LED Lamp | Mobile LED-Leuchte.  
 Dimensions H 115 cm, Ø 15 cm  
 Materials Ab, K3  
 Colour Warm Gray  
 Features 3 light colours, infinitely dimmable  
 3 Lichtfarben, stufenlos dimmbar



**FAROL FLOOR 66726**

Mobile LED Lamp | Mobile LED-Leuchte  
 Dimensions H 115 cm, Ø 15 cm  
 Materials Ab, K3  
 Colour Rusty Look  
 Features 3-step switch | 3-stufig schaltbar  
 Luminous colour | Lichtfarbe: 3000K



**FAROL FLOOR 66221**

Mobile LED Lamp | Mobile LED-Leuchte  
 Dimensions H 115 cm, Ø 15 cm  
 Materials Ab, K3  
 Colour Gunmetal, metallic finish  
 Features 3-step switch | 3-stufig schaltbar  
 Luminous colour | Lichtfarbe: 3000K



**FAROL FLOOR 66222**

Mobile LED Lamp | Mobile LED-Leuchte.  
 Dimensions H 115 cm, Ø 15 cm  
 Materials Ab, K3  
 Colour Burned Metal, metallic finish  
 Features 3-step switch | 3-stufig schaltbar  
 Luminous colour | Lichtfarbe: 3000K



## OUTDOOR ESSENTIALS

### ANI LAMP MINI 67073

Mobile LED Lamp | Mobile LED-Leuchte  
 Dimensions H 21,5 cm, Ø 14,5 cm  
 Materials Ab, K3, K4  
 Colour White  
 Features 3 light colours, infinitely dimmable  
 3 Lichtfarben, stufenlos dimmbar



67073  
White



67074  
Satellite



67076  
Warm Gray



67075  
Magnet

### ANI LAMP 65928

Mobile LED Lamp | Mobile LED-Leuchte  
 Dimensions H 33,5 cm, Ø 22 cm  
 Materials Ab  
 Colour White  
 Features Base, rope, charger and USB-cable are included in delivery. 2-step switch  
 Seil, Ladestation und USB-Kabel sind im Lieferumfang enthalten. 2-stufig schaltbar



65928  
White



65929  
Satellite



66067  
Warm Gray



65930  
Magnet

### ANI LAMP MINI

Same design, different functions – our ANI LAMP MINI by the designer duo Florian Kallus und Sebastian Schneider. Whether indoors or outdoors, the ANI LAMP MINI is always at hand and provides fascinating light. A simple touch in the centre is all it takes to unleash the magic. Select from three spectral colours and adjust the desired brightness by keeping your finger on the touch area. Small but powerful: The ANI LAMP MINI brings proven performance in a handy format. The supplied charging station makes charging effortless. Even while charging, it is ready to light up your home. Charge lasts 7-35 hours, splash-proof, available in several colours as well as sizes.

### ANI LAMP MINI

Gleiches Design, andere Funktionen – unsere ANI LAMP MINI von dem Designer-Duo Florian Kallus und Sebastian Schneider! Ob drinnen oder draußen, die ANI LAMP MINI ist immer dabei und sorgt für faszinierendes Licht. Ein einfaches Berühren in der Mitte genügt, um die Magie zu entfesseln. Wähle aus drei Lichttönen aus und passe die Helligkeit nach deinem Wunsch an, indem du den Berührungsbereich gedrückt hältst. Klein, aber kraftvoll: Die ANI LAMP MINI bringt die bewährte Leistung in einem handlichen Format. Die beigelegte Ladestation ermöglicht ein müheloses Aufladen. Während sie auflädt, bleibt sie stets einsatzbereit, um dein Zuhause zu erhellen. Brenndauer 7-35 Stunden, spritzwassergeschützt, in mehreren Farben sowie Größen erhältlich.



### ANI LAMP MINI

In-/Outdoor use | In-/Outdoorbenutzung

Battery operated | Akkubetrieb

Charging dock | Stationsladung

Operation time | Brenndauer: **7-35 h**

Luminous flux | Lichtstrom: **80 lm**

Output | Leistung: **1 W**

Voltage | Spannung: **DC 3.7 V**

Protection class | Schutzklasse: **III**

Water tightness | Wasserdichtigkeit: **IP 54**

Luminous colour | Lichtfarbe: **2700-4000K**

Input: **DC5V/1A**

Charging Time | Ladezeit: **2.5 h**





ANI LAMP

In-/Outdoor use   In-/Outdoorbenutzung	
Battery operated   Akkubetrieb	
Charging dock   Stationsladung	
Operation time   Brenndauer:	7-35 h
Luminous flux   Lichtstrom:	110 lm
Output   Leistung:	0.8 W
Voltage   Spannung:	DC 3.7 V
Protection class   Schutzklasse:	III
Water tightness   Wasserdichtigkeit:	IP 44
Luminous colour   Lichtfarbe:	2700-4000K
Input:	5V/DC 1A
Charging Time   Ladezeit:	2 h



The QR code leads you to the ANI LAMP video. | Der QR-Code führt Sie zum ANI LAMP Video.



**ANI LAMP - PORTABLE, INTUITIVE, SURPRISINGLY VERSATILE.**

Thanks to the integrated battery, ANI LAMP is particularly versatile. The mobile LED-lamp was designed by the young designer duo Florian Kallus and Sebastian Schneider. The luminaire is operated by briefly touching the rings on the lampshade. This allows the user to select between different brightness levels as well as control the switching on and off of the luminaire. The light cone and the light output can be changed by simply turning the lampshade of the ANI LAMP. The luminaire can be placed on a stand, hung on a rope, or placed on a table. For recharging, the ANI LAMP is placed on a charging cradle and charged with the USB cable, which is included.

**ANI LAMP - PORTABEL, INTUITIV, ÜBERRASCHEND VIELSEITIG.**

ANI LAMP ist dank des integrierten Akkus besonders vielseitig einsetzbar. Entworfen wurde die mobile LED-Leuchte von dem jungen Designer-Duo Florian Kallus und Sebastian Schneider. Bedient wird die Leuchte durch ein kurzes Berühren der Ringe auf dem Lampenschirm. So lassen sich unterschiedliche Helligkeitsstufen, sowie das Ein- und Ausschalten der Leuchte steuern. Durch einfaches Umdrehen des Lampenschirms der ANI LAMP kann der Lichtkegel und die Lichtausbeute verändert werden. Die Leuchte kann auf einen Standfuß gesetzt werden, an einem Seil hängen, oder auf einen Tisch gestellt werden. Zum Wiederaufladen wird die ANI LAMP auf eine Ladeschale gesetzt und mit dem beigegeführten USB-Kabel geladen.

H 33,5 cm

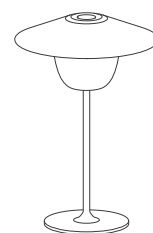

H 21,5 cm

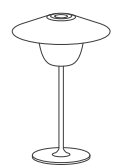

MINI

## TURAS 67262

Mobile LED Lamp | Mobile LED Leuchte  
 Dimensions H 23 cm, Ø 7.5 cm  
 Materials Ab, K3, K4  
 Colour White



67262  
White



67264  
Silk Gray



67265  
Granite Gray



67263  
Black

## 67246

Remote Control | Fernbedienung  
 Dimensions H 1,5 cm, B 4,5 cm, T 15,5 cm  
 Materials K3  
 Colour Black  
 Features Requires 2 x AAA batteries  
 Benötigt 2 x AAA Batterien



## HOME AND AWAY

If you want to switch several lights on and off at the same time, you can do this conveniently from anywhere using the remote control. You can also adjust the light colour and light intensity. A particular advantage for use in hotels and restaurants is the lock function, which allows you to lock the lights once you have set the right light colour and brightness. This prevents your guests from adjusting or switching off the luminaires, resulting in a different lighting concept than you intended for your catering area.

## DAHEIM UND UNTERWEGS

Wenn Sie mehrere Leuchten gleichzeitig ein und ausschalten möchten, können Sie das ganz bequem von überall aus mit der Fernbedienung. Außerdem können Sie die Lichtfarbe sowie die Lichtintensität einstellen. Ein besonderer Pluspunkt für die Nutzung im Hotel- und Gastrobereich; dank einer Lockfunktion können Sie die Leuchten, nachdem Sie die passende Lichtfarbe und Helligkeit eingestellt haben, sperren. So verhindern Sie, dass Ihre Gäste die Leuchten verstellen oder ausschalten und sich damit ein anderes Lichtkonzept ergibt, als Sie es für Ihren Gastronomiebereich vorgesehen haben.

## TURAS MOBILE LED LAMP

TURAS – Scottish for travelling, describes an outdoor luminaire from blomus that is reduced to a minimum and yet has everything a luminaire needs to be able to do: Conjure up atmosphere and mood in special situations. The small luminaire head is equipped with powerful LEDs that provide the perfect lighting for your special moments in three different light colours. The luminaire is completely unobtrusive and blends in perfectly with any surroundings thanks to its minimalist design.

A table decorated with TURAS LED lights never looks overloaded, but it does have that certain something and gives you space for exciting conversations and time together. Available in four high-quality outdoor powder coatings, you can also choose between the two blomus outdoor colours Silk Gray and Granite Gray in addition to classic white and black. Turn pure lighting into a statement and classic table lamps into a design piece!

## TURAS MOBILE LED LEUCHE

TURAS – schottisch für Reisen, beschreibt eine Outdoor Leuchte aus dem Hause blomus, die auf ein Minimum reduziert ist und dennoch alles mit bringt, was eine Leuchte können muss: Atmosphäre und Stimmung in besondere Situationen zaubern. Der kleine Leuchtenkopf ist mit leistungsstarken LEDs ausgestattet, die in drei verschiedenen Lichtfarben die perfekte Beleuchtung in Ihre besonderen Momente bringen. Dabei nimmt sich die Leuchte komplett zurück und fügt sich dank ihres minimalistischen Designs in jede Umgebung optimal ein.

Ein Tisch, der mit den TURAS LED Leuchten dekoriert ist, wirkt niemals überladen, erhält aber das gewisse Etwas und lässt Ihnen Raum für spannende Gespräche und gemeinsame Stunden. Verfügbar in vier qualitativen Outdoor-Pulverbeschichtungen können Sie zwischen klassischem Weiß und Schwarz auch zwischen den beiden blomus Outdoorfarben Silk Gray und Granite Gray wählen. Machen Sie aus reiner Beleuchtung ein Statement und aus klassischen Tischleuchten ein Design-Piece!

**KODU 67266**

Mobile LED Lamp | Mobile LED Leuchte  
 Dimensions H 20 cm, B 6,5 cm, T 6,5 cm  
 Materials Ab, K3, K4  
 Colour White



67266  
White



67268  
Silk Gray



67269  
Granite Gray



67267  
Black



**TURAS**

In-/Outdoor use   In-/Outdoorbenutzung	
Battery operated   Akkubetrieb	
Charging dock   Stationsladung	
Operation time   Brenndauer:	<b>7-91 h</b>
Luminous flux   Lichtstrom:	<b>83 lm</b>
Output   Leistung:	<b>1.5 W</b>
Voltage   Spannung:	<b>DC 3.7 V</b>
Protection class   Schutzklasse:	<b>III</b>
Water tightness   Wasserdichtigkeit:	<b>IP 65</b>
Luminous colour   Lichtfarbe:	<b>2200, 2700K</b>
Input:	<b>DC5V/1A</b>
Charging Time   Ladezeit:	<b>2h</b>

**KODU**

In-/Outdoor use   In-/Outdoorbenutzung	
Battery operated   Akkubetrieb	
Charging dock   Stationsladung	
Operation time   Brenndauer:	<b>9.5-136.5 h</b>
Luminous flux   Lichtstrom:	<b>136 lm</b>
Output   Leistung:	<b>2.2 W</b>
Voltage   Spannung:	<b>DC 3.7 V</b>
Protection class   Schutzklasse:	<b>III</b>
Water tightness   Wasserdichtigkeit:	<b>IP 65</b>
Luminous colour   Lichtfarbe:	<b>2200, 2700K</b>
Input:	<b>DC5V/1A</b>
Charging Time   Ladezeit:	<b>3.5h</b>

**KODU MOBILE LED LAMP**

The KODU table lamp is a new take on the classic table lamp: It now sees itself not only as a light source, but also adds the finishing touch to your table decorations and perfects the mood for cosy get-togethers. Choose between three light colours and dim the lights to your desired light intensity.

KODU means home and at home in Estonian and conveys a feeling of home and security wherever you are. Available in four high-quality outdoor powder coatings, you can also choose between the two blomus outdoor colours Silk Gray and Granite Gray in addition to classic white and black. Turn pure lighting into a statement and classic table lamps into design pieces!

**KODU MOBILE LED LEUCHE**

Mit der KODU Tischleuchte wird die klassische Tischleuchte neu gedacht: Inzwischen versteht sie sich nicht nur als Lichtspender, sondern sorgt für eine Vollendung Ihrer Tischdekoration und perfektioniert die Stimmung beim gemütlichen Beisammensein. Wählen Sie zwischen drei Lichtfarben und dimmen Sie die Leuchten bis zu Ihrer gewünschten Lichtintensität.

KODU bedeutet Daheim und Zuhause in der estnischen Sprache und vermittelt ein Gefühl von Heimat und Geborgenheit, wo immer Sie sich befinden. Verfügbar in vier qualitativen Outdoor-Pulverbeschichtungen können Sie zwischen klassischem Weiß und Schwarz auch zwischen den beiden blomus Outdoorfarben Silk Gray und Granite Gray wählen. Machen Sie aus reiner Beleuchtung ein Statement und aus klassischen Tischleuchten ein Design-Piece!





**FUERA 65033**

Bird Feeder / Bath | Vogel-Rastplatz  
 Dimensions H 122 cm, Ø 25 cm  
 Materials SSm, H1  
 Features Bird feeder in winter - Bird bath in summer | Im Winter Futterstelle - im Sommer Vogeltränke



**CAMPO 65251**

Rain Gauge | Regenmesser  
 Dimensions H 76 cm, Ø 9 cm  
 Materials SSm, K2



**PLANTO 65405**

Watering Can | Gießkanne  
 Dimensions H 19 cm, B 26 cm, Ø 11,5 cm, V 1 l  
 Materials SSm



**FUOCO 65079**

Gel Firepit | Gelfeuerstelle  
 Dimensions H 9,5 cm, Ø 32 cm, V 400 ml, 2h  
 Materials SSp, ST2  
 Features Incl. Snuffer (suitable for burning gel 31036) | Inkl. Löscher (passendes Brenngel 31036)



**31036**

Burning Gel | Brenngel  
 Dimensions V 1 l



**PLANTO 65406**

Watering Can | Gießkanne  
 Dimensions H 20 cm, B 28 cm, Ø 11,5 cm, V 1,5 l  
 Materials SSm



**FUOCO 65078**

Gel Firepit | Gelfeuerstelle  
 Dimensions H 11 cm, Ø 18 cm, V 400 ml, 2h  
 Materials SSp, ST2  
 Features Incl. Snuffer (suitable for burning gel 31036) | Inkl. Löscher (passendes Brenngel 31036)



**MEDA 31056**

Metal-Fluid, V 100 ml

Highly effective metal fluid MEDA for care, protection and cleaning of matt and polished metal surfaces indoors, such as stainless steel, aluminum, chrome as well as ceramics, wood, glass and plastics. NSF registered.  
 Hochwirksames Metal-Fluid MEDA für Pflege, Schutz und Reinigung von matten und polierten Metalloberflächen im Innenbereich, wie Edelstahl, Aluminium, Chrom sowie Keramik, Holz, Glas und Kunststoffe. NSF-registriert.





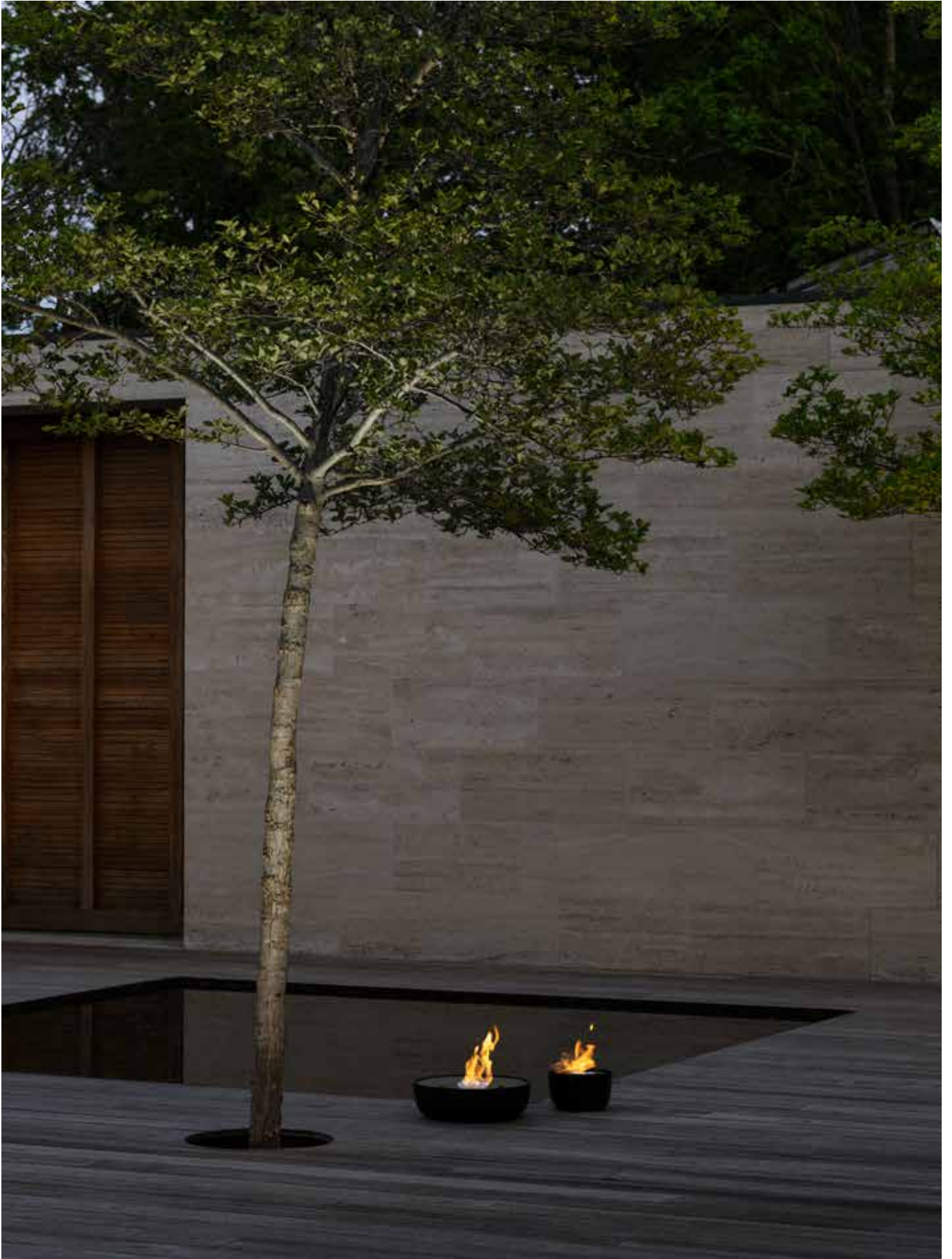



PRODUCTS

---

PROMOTION



# PROMOTION

## ALDOA 63169

\* Water Carafe | Wasserkaraffe  
 Dimensions H 30 cm, Ø 10 cm, V 0,9 l  
 Materials SSm, Gk  
 Features With self-closing lid  
 Mit selbstschließendem Deckel



## PEASY 64483

\* Tray | Tablett  
 Dimensions H 1,4 cm, Ø 30 cm  
 Materials SSm

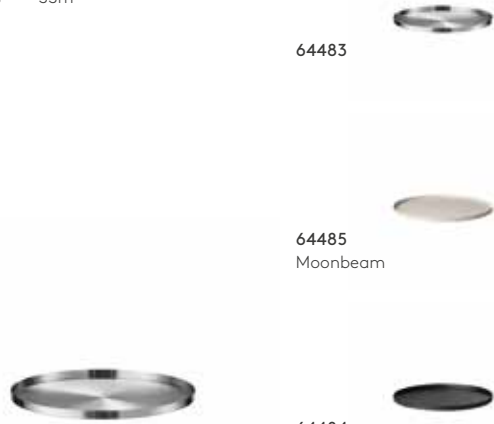

64483

64485  
Moonbeam

64484  
Black

## LIVO 63581

\* Salt and Pepper Set | Salz und Pfefferset  
 Dimensions H 12 cm, Ø 3,5 cm, V 0,04 l  
 Materials SSm, Gk



## PEASY 64486

\* Tray | Tablett  
 Dimensions H 1,4 cm, Ø 38 cm  
 Materials SSm



64486

64488  
Moonbeam

64487  
Black

## PEGOS 64135

\* Tray | Tablett  
 Dimensions H 3,5 cm, B 32 cm, T 50 cm  
 Materials SSm, K3, K4  
 Colour Warm Gray



64135  
Warm Gray



64136  
Satellite



## COLO 64097

\* Paper Towel Holder | Küchenrollenhalter  
 Dimensions H 31,5 cm, Ø 16 cm  
 Materials SSb  
 Colour Moonbeam



64097  
Moonbeam

64099  
Magnet

**DESA 64206**

\* Bread Basket | Brotkorb  
 Dimensions H 10,5 cm, B 20 cm, T 20 cm  
 Materials SSb, T1  
 Colour Moonbeam  
 Features For cleaning purposes simply remove the cotton liner  
 Zum Waschen kann der Stoffeinsatz einfach herausgenommen werden,  
 Size: S



64206  
Moonbeam



64202  
Magnet



64200  
Black



**DESA 64207**

\* Bread Basket | Brotkorb  
 Dimensions H 11 cm, B 26 cm, T 26 cm  
 Materials SSb, T1  
 Colour Moonbeam  
 Features For cleaning purposes simply remove the cotton liner  
 Zum Waschen kann der Stoffeinsatz einfach herausgenommen werden,  
 Size: L



64207  
Moonbeam



64203  
Magnet



64201  
Black



**TELA 68883**

\* Crochet Rope Basket | Häkelkorb  
 Dimensions H 9 cm, B 15 cm, T 10 cm  
 Materials T3  
 Colour Sand  
 Features Size: M



68883  
Sand



66467  
Moonbeam



66468  
Bark



68884  
Taupe



66469  
Fungi



68882  
Anthracite



66470  
Black



**TELA 68886**

\* Crochet Rope Basket | Häkelkorb  
 Dimensions H 9 cm, B 20 cm, T 12 cm  
 Materials T3  
 Colour Sand  
 Features Size: L



68886  
Sand



66471  
Moonbeam



66472  
Bark



68887  
Taupe



66473  
Fungi



68885  
Anthracite



66474  
Black



\* Special order conditions apply for this product. Für diesen Artikel gelten besondere Bestellbedingungen.

## PROMOTION

### FINCA 63686

\* Lantern | Laterne

Dimensions H 30,5 cm, B 20,5 cm, T 21 cm

Materials Sb, Gk

Colour Black

Features For indoor use only. Without candle  
Nur für Innenräume geeignet.  
Ohne Kerze



### FINCA 63687

\* Lantern | Laterne

Dimensions H 36 cm, B 20,5 cm, T 21 cm

Materials Sb, Gk

Colour Black

Features For indoor use only. Without candle  
Nur für Innenräume geeignet.  
Ohne Kerze



### FINCA 63688

\* Lantern | Laterne

Dimensions H 46 cm, B 20,5 cm, T 21 cm

Materials Sb, Gk

Colour Black

Features For indoor use only. Without candle  
Nur für Innenräume geeignet.  
Ohne Kerze



### TUBO PEDAL BIN

Smart helper in the kitchen and bathroom. The TUBO family of elegant pedal bins includes classic colours as well as metallic colours such as Burned Metal and Brass, and is now also available in bold colours from the Capsule Collection. The simple design matches both classic and modern furnishing styles.

Equipped with the Smart Close system, the lid opens and closes almost silently. With removable bucket.

### TUBO TRETEIMER

Smarter Helfer in Küche und Bad. Die Familie der eleganten Treteimer TUBO umfasst neben klassischen Farbtönen auch metallische Farben wie Burned Metal und Brass und zeigt sich nun auch in mutigen Farben der Capsule Collection. Das schlichte Design passt zu klassischen, als auch modernen Einrichtungsstilen.

Ausgestattet mit dem Smart-Close-System öffnet und schließt sich der Deckel fast lautlos. Mit herausnehmbarem Eimer.

### TUBO 67554

\* Pedal Bin | Treteimer

Dimensions H 24,5 cm, Ø 17 cm, V 3 l

Materials Sb, K3

Colour Mazarine Blue

Features With removable bucket  
Mit herausnehmbarem Eimer



67554 - NEW  
Mazarine Blue



68945  
White



68993  
Moon-Gray



68889  
Sand



68890  
Taupe



69159  
Tarmac



68888  
Anthracite



69214  
Black



**TUBO 65811**

\* Pedal Bin | Treteimer  
 Dimensions H 24,5 cm, Ø 17 cm, V 3 l  
 Materials SSt, K3  
 Colour Brass, metallic finish  
 Features With removable bucket  
 Mit herausnehmbarem Eimer

**65811**  
 Brass, metallic finish



**65812**  
 Burned Metal, metallic finish



**FRISCO LOUNGE 69257**

\* Laundry Bin | Wäschesammler  
 Dimensions H 67 cm, B 45 cm, T28 cm,  
 V 65 l  
 Materials Ab, T3  
 Colour Steel Gray Melange

**69257**  
 Ashes of Roses Melange



**69256**  
 Warm Gray Melange



**69255**  
 Steel Gray Melange



**FRISCO 65387**

\* Laundry Bin | Wäschesammler  
 Dimensions H 67 cm, B 45 cm, T 28 cm, V 65 l  
 Materials Ab, T3  
 Colour Silver Gray

**65382**  
 Sand



**65387**  
 Silver Gray



**65386**  
 Taupe



**65384**  
 Anthracite



**65348**  
 Black



\* Special order conditions apply for this product. Für diesen Artikel gelten besondere Bestellbedingungen.

# PROMOTION

## SPIRIT 68351

\* Mobile LED Lamp | Mobile LED-Leuchte

Dimensions H 15 cm, Ø 9 cm

Materials SSm, K3

Colour Mocha Mousse

Features 3 light colours, infinitely dimmable  
3 Lichtfarben, stufenlos dimmbar,  
Size: M



**68351 - NEW**  
Mocha Mousse



**68354 - NEW**  
Pine Gray



**66062**  
Moonbeam



**66060**  
Platinum Gray



**66061**  
Warm Gray



## SPIRIT 68352

\* Mobile LED Lamp | Mobile LED-Leuchte

Dimensions H 25 cm, Ø 15 cm

Materials SSm, K3

Colour Mocha Mousse

Features 3 light colours, infinitely dimmable  
3 Lichtfarben, stufenlos dimmbar,  
Size: L



**68352 - NEW**  
Mocha Mousse



**68355 - NEW**  
Pine Gray



**66065**  
Moonbeam



**66063**  
Platinum Gray



**66064**  
Warm Gray



## SPIRIT 68353

\* Mobile LED Lamp | Mobile LED-Leuchte

Dimensions H 35 cm, Ø 21,5 cm

Materials SSm, K3

Colour Mocha Mousse

Features 3 light colours, infinitely dimmable  
3 Lichtfarben, stufenlos dimmbar,  
Size: XL



**68353 - NEW**  
Mocha Mousse



**68356 - NEW**  
Pine Gray



**66237**  
Moonbeam



**66235**  
Platinum Gray



**66236**  
Warm Gray





## SPIRIT

In-/Outdoor use | In-/Outdoorbenutzung

Battery operated | Akkubetrieb

USB plug | USB Ladung

	SPIRIT M	SPIRIT L	SPIRIT XL
Operation time   Brenndauer:	7-35 h	9.5-47.5 h	9.5-47.5 h
Luminous flux   Lichtstrom:	110 lm	155 lm	400 lm
Output   Leistung:	1W	1.5W	3W
Voltage   Spannung:	DC 3.7 V	DC 3.7 V	DC 3.7 V
Protection class   Schutzklasse:	III	III	III
Water tightness   Wasserdichtigkeit:	IP 44	IP 44	IP 44
Luminous colour   Lichtfarbe:	2700-4000K	2700-4000K	2700K-4000K
Input:	5V/DC 1A	5V/DC 1A	5V/DC 1A
Charging Time   Ladezeit:	2.5 h	4.5 h	4.5 h

\* Special order conditions apply for this product. Für diesen Artikel gelten besondere Bestellbedingungen.

# PROMOTION

## CALMA 64720

\* Tealight Holder, Set of 2 | Windlicht, Set 2 Stück  
 Dimensions H 9,5 cm, Ø 7 cm  
 Materials ST8r, Gk  
 Colour Moonbeam  
 Features Polyresin, 50% recycled. Without tealights. Suitable for tealights up to Ø 40 mm | Polyresin, 50% recycelt. Ohne Teelichter. Für Teelichter bis Ø 40 mm geeignet, Size: XS



64720 Moonbeam



64724 Satellite



64728 Magnet



64732 Cedar Wood



64736 Agave Green

## CALMA 64721

\* Tealight Holder | Windlicht  
 Dimensions H 14 cm, Ø 10 cm  
 Materials ST8r, Gk  
 Colour Moonbeam  
 Features Polyresin, 50% recycled. Without tealight. Suitable for tealights up to Ø 55 mm | Polyresin, 50% recycelt. Ohne Teelicht. Für Teelichter bis Ø 55 mm geeignet, Size: S



64721 Moonbeam



64725 Satellite



64729 Magnet



64733 Cedar Wood



64737 Agave Green

## CALMA 64722

\* Hurricane Lamp | Windlicht  
 Dimensions H 20 cm, Ø 12 cm  
 Materials ST8r, Gk  
 Colour Moonbeam  
 Features Polyresin, 50% recycled. Without candle. Suitable for candles up to Ø 50 mm, H 100 mm | Polyresin, 50% recycelt. Ohne Kerze. Für Kerzen bis Größe Ø 50 mm, H 100 mm geeignet, Size: M



64722 Moonbeam



64726 Satellite



64730 Magnet



64734 Cedar Wood



64738 Agave Green



**CALMA 64723**

\* Hurricane Lamp | Windlicht

Dimensions H 22,5 cm, Ø 15 cm

Materials ST8r, Gk

Colour Moonbeam

Features Polyresin, 50% recycled. Without candle.  
Suitable for candles up to Ø 70 mm,  
H 100 mm | Polyresin, 50% recycelt.  
Ohne Kerze. Für Kerzen bis Größe  
Ø 70 mm, H 100 mm geeignet, Size: L



**64723**  
Moonbeam



**64727**  
Satellite



**64731**  
Magnet



**64735**  
Cedar Wood



**64739**  
Agave Green

**CALMA – A NEW LOOK**

The CALMA range is having a makeover – new material, new colors! The well-known CALMA lanterns are now made from 50% recycled polyresin, giving our existing design a new look. Light fibers of the recycled material are visible in the surface of the base, making every item unique. The clear glass complements the colours in a classic way.

Sizes XS and S can be fitted with a tealight and for sizes M and L, pillar candles are perfect.

**CALMA – EIN NEUER LOOK**

Das CALMA Sortiment erlebt einen Umschwung – neues Material, neue Farben! Die bekannten CALMA Windlichter nun aus 50% recyceltem Polyresin, lassen unser bestehendes Design neu wirken. In der Oberfläche der Base sind leichte Fasern des recycelten Materials erkennbar, so dass jeder Artikel ein Unikat ist. Das klare Glas ergänzt die Farben klassisch.

Größe XS und S können mit einem Teelicht ausgestattet werden und für Größe M und L eignen sich Stumpenkerzen perfekt.



\* Special order conditions apply for this product. Für diesen Artikel gelten besondere Bestellbedingungen.

## PROMOTION

### CALMA 67307

\* Tealight Holder, Set of 2 | Windlicht, Set 2 Stück  
 Dimensions H 9,5 cm, Ø 7 cm  
 Materials SSm, Gf  
 Colour Smoke  
 Features Without tealights. Suitable for tealights up to Ø 40 mm  
 Ohne Teelichter. Für Teelichter bis Ø 40 mm geeignet, Size: XS



### CALMA 67308

\* Tealight Holder | Windlicht  
 Dimensions H 14 cm, Ø 10 cm  
 Materials SSm, Gf  
 Colour Smoke  
 Features Without tealight. Suitable for tealights up to Ø 55 mm  
 Ohne Teelicht. Für Teelichter bis Ø 55 mm geeignet, Size: S



### CALMA 67309

\* Hurricane Lamp | Windlicht  
 Dimensions H 20 cm, Ø 12 cm  
 Materials SSm, Gf  
 Colour Smoke  
 Features Without candle. Suitable for candles up to Ø 50 mm, H 100 mm  
 Ohne Kerze. Für Kerzen bis Größe Ø 50 mm, H 100 mm geeignet, Size: M



### CALMA 64716

\* Tealight Holder, Set of 2 | Windlicht, Set 2 Stück  
 Dimensions H 9,5 cm, Ø 7 cm  
 Materials SSl, Gf  
 Colour Burned Metal, metallic finish  
 Features Without tealights. Suitable for tealights up to Ø 40 mm  
 Ohne Teelichter. Für Teelichter bis Ø 40 mm geeignet, Size: XS



### CALMA 64717

\* Tealight Holder | Windlicht  
 Dimensions H 14 cm, Ø 10 cm  
 Materials SSl, Gf  
 Colour Burned Metal, metallic finish  
 Features Without tealight. Suitable for tealights up to Ø 55 mm  
 Ohne Teelicht. Für Teelichter bis Ø 55 mm geeignet, Size: S



### CALMA 67310

\* Hurricane Lamp | Windlicht  
 Dimensions H 22,5 cm, Ø 15 cm  
 Materials SSm, Gf  
 Colour Smoke  
 Features Without candle. Suitable for candles up to Ø 70 mm, H 100 mm  
 Ohne Kerze. Für Kerzen bis Größe Ø 70 mm, H 100 mm geeignet, Size: L



### CALMA 64718

\* Hurricane Lamp | Windlicht  
 Dimensions H 20 cm, Ø 12 cm  
 Materials SSl, Gf  
 Colour Burned Metal, metallic finish  
 Features Without candle. Suitable for candles up to Ø 50 mm, H 100 mm  
 Ohne Kerze. Für Kerzen bis Größe Ø 50 mm, H 100 mm geeignet, Size: M



### CALMA 64719

\* Hurricane Lamp | Windlicht  
 Dimensions H 22,5 cm, Ø 15 cm  
 Materials SSl, Gf  
 Colour Burned Metal, metallic finish  
 Features Without candle. Suitable for candles up to Ø 70 mm, H 100 mm  
 Ohne Kerze. Für Kerzen bis Größe Ø 70 mm, H 100 mm geeignet, Size: L



### CALMA 66231

\* Hurricane Lamp | Windlicht  
 Dimensions H 22,5 cm, Ø 15 cm  
 Materials ST4, Gf  
 fColour Steel Gray, smoke  
 Features Without candle. Suitable for candles up to Ø 70 mm, H 100 mm  
 Ohne Kerze. Für Kerzen bis Größe Ø 70 mm, H 100 mm geeignet, Size: L



**CALMA 66254**

\* Tealight Holder, Set of 2 |  
Windlicht, Set 2 Stück  
Dimensions H 9,5 cm, Ø 7 cm  
Materials ST4, Gk  
Colour Concrete  
Features Without tealights. Suitable for tealights up to Ø 40 mm  
Ohne Teelichter. Für Teelichter bis Ø 40 mm geeignet, Size: XS



66254  
Concrete



66949  
Fungi



**CALMA 65432**

\* Tealight Holder | Windlicht  
Dimensions H 14 cm, Ø 10 cm  
Materials ST4, Gk  
Colour Concrete  
Features Without tealight. Suitable for tealights up to Ø 55 mm  
Ohne Teelicht. Für Teelichter bis Ø 55 mm geeignet, Size: S



65432  
Concrete



66950  
Fungi



**CALMA 65444**

\* Hurricane Lamp | Windlicht  
Dimensions H 20 cm, Ø 12 cm  
Materials ST4, Gk  
Colour Concrete  
Features Without candle. Suitable for candles up to Ø 50 mm, H 100 mm | Ohne Kerze.  
Für Kerzen bis Größe Ø 50 mm, H 100 mm geeignet, Size: M



65444  
Concrete



66951  
Fungi



**CALMA 65448**

\* Hurricane Lamp | Windlicht  
Dimensions H 22,5 cm, Ø 15 cm  
Materials ST4, Gk  
Colour Concrete  
Features Without candle. Suitable for candles up to Ø 70 mm, H 100 mm | Ohne Kerze.  
Für Kerzen bis Größe Ø 70 mm, H 100 mm geeignet, Size: L



65448  
Concrete



66952  
Fungi



**CALMA 66230**

\* Hurricane Lamp | Windlicht  
Dimensions H 20 cm, Ø 12 cm  
Materials ST4, Gf  
Colour Steel Gray, smoke  
Features Without candle. Suitable for candles up to Ø 50 mm, H 100 mm  
Ohne Kerze. Für Kerzen bis Größe Ø 50 mm, H 100 mm geeignet, Size: M



**CALMA 66189**

\* Tealight Holder | Windlicht  
Dimensions H 14 cm, Ø 10 cm  
Materials ST4, Gf  
Colour Steel Gray, smoke  
Features Without tealight. Suitable for tealights up to Ø 55 mm  
Ohne Teelicht. Für Teelichter bis Ø 55 mm geeignet, Size: S



**CALMA 66255**

\* Tealight Holder, Set of 2 | Windlicht, Set 2 Stück  
Dimensions H 9,5 cm, Ø 7 cm  
Materials ST4, Gf  
Colour Steel Gray, smoke  
Features Without tealights. Suitable for tealights up to Ø 40 mm  
Ohne Teelichter. Für Teelichter bis Ø 40 mm geeignet, Size: XS



\* Special order conditions apply for this product. Für diesen Artikel gelten besondere Bestellbedingungen.



BLOMUS

---

# VARIOUS

DESIGNERS	P. 352
SUSTAINABILITY	P. 356
POS	P. 358
SHOWROOM	P. 359
CONTACT	P. 360

## THE DESIGNERS

blomus continues to be known for its devotion to exquisite quality, a highly innovative approach to product development and a desire to look beyond the mere aesthetics of a product and view its practical properties as equally important.

In combination with an overall design philosophy that expresses simplicity, feminine sensibility and an uncompromising approach to colour, shape and choice of material, this has secured blomus a position as a major player on the international design scene.

blomus setzt traditionell auf exquisite Qualität, verfolgt einen hochinnovativen Ansatz bei der Produktentwicklung und hält an dem Ideal fest, über die Ästhetik eines Produkts hinaus seine praktischen Eigenschaften gleich stark auszuprägen.

In Kombination mit einer übergreifenden Designphilosophie, die Einfachheit, weibliche Sensibilität und einen stringenten Umgang mit Farbe, Form und Material auszeichnet, hat sich blomus einen festen Platz unter den Hauptakteuren der internationalen Designszene gesichert.



DESIGNERS

KASCHKASCH

[kaschkasch.com](http://kaschkasch.com)



DESIGNER

THERESA RAND

[theresarand.com](http://theresarand.com)



DESIGNER

CARSTEN GOLLNICK

[gollnick-design.de](http://gollnick-design.de)



DESIGNER

SEBASTIAN HERKNER

[sebastianherkner.com](http://sebastianherkner.com)



DESIGNER

KAZUSHIGE MIYAKE

[kazushigemiyake.com](http://kazushigemiyake.com)



DESIGNER

ROBIN SCHOLTYSIK

[robinscholtysik.de](http://robinscholtysik.de)





DESIGNER

NADINE KÜMMEL

[nadinekummel.de](http://nadinekummel.de)



DESIGNER

ADAM MILLER

[ad-miller.com](http://ad-miller.com)



DESIGNER

NICOLAI FUHRMANN

[nicolai fuhrmann.de](http://nicolai fuhrmann.de)



DESIGNER

PETER LIENHART

[blomus.com](http://blomus.com)



DESIGNER

ILJA HUBER

[iljahuber.com](http://iljahuber.com)



DESIGNER

JUSTYNA POPLAWSKA

[justynapoplawska.com](http://justynapoplawska.com)



DESIGNER

DAVID MEIER

[studiomeiid.com](http://studiomeiid.com)



DESIGNER

NINA THÖMING

[floeze.de](http://floeze.de)



DESIGNER

DANIEL LAVONIUS  
JAREFELDT

[lavoniusjarefeldt.se](http://lavoniusjarefeldt.se)



DESIGNER

LUCA GALMARINI

[luca-galmarini.com](http://luca-galmarini.com)



DESIGNER

FREDERIKE MARTENS

[blomus.com](http://blomus.com)



DESIGNER

ANTON BJÖRSING

[antonbjorsing.com](http://antonbjorsing.com)

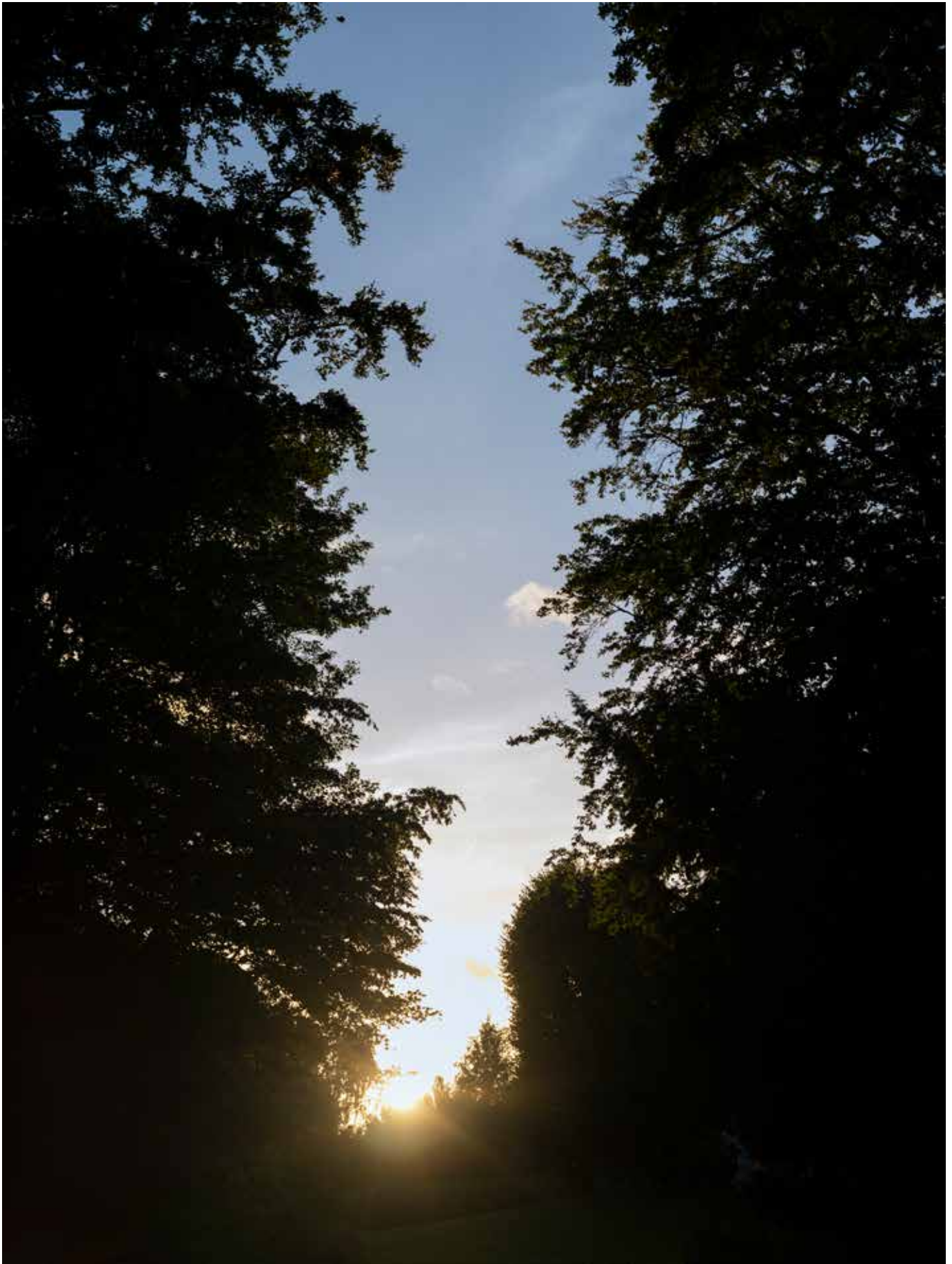

At blomus, we proactively work to integrate sustainability into every corner of our business – from the longevity of our products and the packaging materials we use to the way we collaborate with our partners. We view ourselves as an active and responsible part of modern society, and we are committed to making better choices every day, thereby minimising our social and environmental impact. We strive to be just as ambitious when it comes to sustainability as we are with regard to product design, innovation and quality.

### **Design Philosophy: timeless and relevant**

We all know it: to stop consuming is the only truly sustainable choice. However, when this is not an option, we believe that buying less and buying better is the best solution. We wish to support the notion of conscious consumerism in the sense that when we all invest in quality, the chances are that products will last longer, and there will be no need to replace them. We aim to offer high-quality products with timeless designs. Even while we recognise the importance of trends, we always ask ourselves whether a product will stay relevant or whether it is merely expression of a short-lived craze. We constantly consider the interplay between the functional, practical and aesthetic qualities of any given blomus product to ensure that it will easily integrate into modern life; put simply, that it will fulfil a practical need, work in your daily life and bring joy, rather than being quickly discarded because it has broken or become irrelevant.

### **Materials: certificates and testing**

All our products are tested to meet legal requirements in all markets where we operate. On top of this, a large number of our textile, wood, paper and cardboard products are certified according to the standards of organisations such as FSC®, GOTS or OEKOTEX®. Read more about the steps we are taking to become more sustainable, and about the organisations that certify our products by scanning the QR code below and look out for our FSC®-certified products.

Wir bei blomus arbeiten proaktiv daran, Nachhaltigkeit in alle Bereiche unseres Unternehmens zu integrieren – von der Langlebigkeit unserer Produkte über die von uns verwendeten Verpackungsmaterialien bis hin zur Zusammenarbeit mit unseren Partnern. Wir sehen uns als einen aktiven und verantwortungsbewussten Teil der modernen Gesellschaft und wir verpflichten uns, jeden Tag bessere Entscheidungen zu treffen und so unsere sozialen und ökologischen Auswirkungen zu minimieren. Wir sind bestrebt, bei der Nachhaltigkeit genauso ehrgeizig zu sein wie bei der Produktgestaltung, Innovation und Qualität.

### **Design-Philosophie: zeitlos und relevant**

Was wir alle wissen: Die einzige wirklich nachhaltige Entscheidung besteht darin, mit dem Konsum aufzuhören. Wenn dies jedoch keine Option ist, glauben wir, dass es die beste Lösung ist, weniger zu kaufen und besser zu kaufen. Wir möchten die Vorstellung eines bewussten Konsums in dem Sinne unterstützen, dass, wenn wir alle in Qualität investieren, die Chancen bestehen, dass Produkte länger halten und nicht ersetzt werden müssen. Unser Ziel ist es, qualitativ hochwertige Produkte mit zeitlosen Designs anzubieten. Auch wenn wir uns der Bedeutung von Trends bewusst sind, fragen wir uns immer, ob ein Produkt relevant bleibt oder ob es nur Ausdruck einer kurzlebigen Modeerscheinung ist. Wir denken laufend über das Zusammenspiel der funktionalen, praktischen und ästhetischen Qualitäten eines jeden blomus-Produkts nach, um sicherzustellen, dass es sich problemlos in das moderne Leben integrieren lässt; vereinfacht gesagt, dass es ein praktisches Bedürfnis erfüllt, im täglichen Leben funktioniert und Freude bereitet, anstatt schnell weggeworfen zu werden, weil es kaputt oder irrelevant geworden ist.

### **Materialien: Zertifikate und Prüfungen**

Alle unsere Produkte sind geprüft, um die rechtlichen Anforderungen auf allen Märkten, auf denen wir tätig sind, zu erfüllen. Darüber hinaus ist eine große Anzahl unserer Textil-, Holz-, Papier- und Kartonprodukte nach den Standards von Organisationen wie FSC®, GOTS oder OEKOTEX® zertifiziert. Erfahren Sie mehr über die Maßnahmen, die wir ergreifen, um nachhaltiger zu werden, und über die Organisationen, die unsere Produkte zertifizieren, indem Sie den unten stehenden QR-Code scannen und halten Sie nach unseren FSC®-zertifizierten Produkten Ausschau.



FSC® N003781



Please scan the QR code to read about our certifications.



Hier finden Sie weitere Informationen zu unseren Zertifizierungen.

## VARIOUS

### 64119

Acrylic logo sign | Logo Acryl Aufsteller  
Dimensions H 6,5 cm, B 11,5 cm, T 2 cm  
Materials K2



### PILAR 98011

Leaflet | Broschüre  
Dimensions H 17,5 cm, B 12 cm  
Features Pilar tableware collection  
Pilar Geschirrkollektion



### SATOMI 98040

Leaflet | Broschüre  
Dimensions H 17,5 cm, B 12 cm  
Features Cosmetic collection  
Kosmetik Kollektion



### STAY 98035

Leaflet | Broschüre  
Dimensions H 17,5 cm, B 12 cm  
Features Outdoor furniture collection  
Stay Outdoor Möbelkollektion



### GROW 98039

Leaflet | Broschüre  
Dimensions H 17,5 cm, B 12 cm  
Features Outdoor furniture collection  
Grow Outdoor Möbelkollektion



### YUA / YUA WIRE 98041

Leaflet | Broschüre  
Dimensions H 17,5 cm, B 12 cm  
Features Yua / Yua Wire Outdoor  
furniture collection  
Yua / Yua Wire Outdoor  
Möbelkollektion



### 99991

blomus shopping bag | blomus Papier-Tragetasche  
Dimensions H 49 cm, B 45 cm, T 17 cm



### 98056

blomus Catalog | blomus Katalog  
Dimensions H 29,7 cm, B 21 cm  
Features The entire 2026 collection  
Die gesamte Kollektion 2026



### 98052

blomus Furniture Catalog | blomus Katalog  
Dimensions H 29,7 cm, B 21 cm  
Features The entire furniture collection  
indoor/outdoor | Die gesamte  
Möbelkollektion Indoor/Outdoor



## COLOUR CARD



Moonbeam

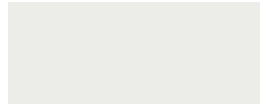

Lily White



Mirage Gray



Micro Chip



Nomad



Mourning Dove



Silk Gray



Sharkskin



Tan



Fungi



Granite Gray



Magnet



Cedar Wood



Satellite



Warm Gray



Smoke



Rustic Brown



Coffee



Espresso



Midnight Plum

## COLOUR CARD - CAPSULE



Transparent Yellow



Amber Brown



Desert Sage



Tradewinds



Cream Gold



Brandy Brown



Agave Green



Parisian Blue



New Wheat



Port



Rain Forest



Mazarine Blue



Indian Tan

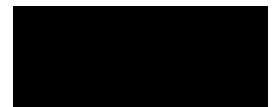

Ocean Cavern